



**creative
cables**



THE CREATIVE

MANIFESTO



1. We don't sell lamps: we create them with you

We think every lamp should be unique: a true reflection of the taste and creativity of those who buy them and enjoy them in their everyday setting.

2. Our goal is to bring light wherever you want

We come up with design systems that allow you to arrange your light, moving it where you most need it.

3. Assembled or divided

Here you can find all the components you need to create your own lamp (don't worry, we have plenty of tips to help guide you through it!) or to customize an already assembled lamp with many different finishings (and in this case all you'll need to do is switch it on!)

4. Born digital but we prefer face-to-face

We were born on the web and, contrary to what usually happens, we subsequently opened our stores across the world: we couldn't wait to meet our Clients in person and share a unique and special bond with them!

5. We are people of the world but we love our territory

We have online and physical stores in more than 25 countries, but we also love our origins and their artisanal traditions. This is why we entrust expert italian artisans with the production of our fabrics, ceramics and wood components.

6. We love people that work with light

This is why we created exclusive services for architects, electricians, interior designers and other professionals.

7. Sturdy and Sustainable

To us sustainability means durability in time. That's why you will be able to exchange every part of your lamp by substituting them when necessary.

8. In case you couldn't tell, we're Italian

Even if we picked out an english name we are still italian and proud, and we're hoping some elements of our origins shine through.

9. We believe in Quality and accessible design

For a reasonable and accessible price we try to offer beauty and the possibility of having fun by creating dazzling ideas.

10. The content, not the container

We prefer to focus on the content rather than on the container: a simple packaging to highlight our colourful products! Custom is our standard

SUMMARY

SPOSTALUCE	7	THE ORIGINAL CREATIVE CABLES	57	LAMP SHADES	167	ELECTRICAL COMPONENTS	231
Moving light on walls and ceilings		Lighting Cables	60	Metal lampshades	169	Switches designed by Achille Castiglioni	232
Spostaluce E27	8	Large section cables	70	Ellepì	174	Creative switch	234
Spostaluce E27 for Lampshades	9	Rope cables	74	Maiolica collection	176	Creative foot switch	235
Spostaluce S-14	10	Ultra Soft silicone electric cable	77	UFO	178	399 & 400 Cylindrical switches	236
FILÉ	13	Extra low voltage cables	78	Ceramic lampshades	182	Dimmer	238
Flat cables lights system		Outdoor EIVA Cables	80	Cement lampshades	186	Creative plug	239
Filé Lamp holders	14	Flat Cables	83	Fabric lampshades	188	Plugs and sockets	239
Filé Accessories	16	LAMP HOLDERS	85	Fibre Lampshades	190	Electrical accessories	242
Flat Cables	18	Metal lamp holders	86	Cablò	196	Adaptors for tracks	243
CREATIVE TUBES	21	P-Light lamp holder	90	ACCESSORIES	199	LIGHT BULBS	245
Decorative conduit system		Wooden lamp holders	91	Pinocchio	200	5V E27 lightbulbs	246
Creative-Tubes	22	Silicone lamp holders	97	Pinocchio XL	202	220V E14 lightbulbs	247
Creative-Tubes terminals	23	Recycled plastic lamp holder	98	Zigh-Zagh	203	220V E27 lightbulbs	248
Creative-tubes boxes	24	Thermoplastic lamp holders	99	Rolè	204	220V S14D	256
Creative-Tubes clips	28	EIVA IP65 lamp holders	100	Archet(TO)	206	B2B SERVICES	259
PORCELAIN SYSTEM	31	Thermoplastic IP44 lamp holder	102	Taché, light bulb support	208	Configurator corner	260
Porcelain Switches - Knob	32	Thermoplastic S14 lamp holder	104	Wooden feet kit - Table lamp support	209	Display cases	263
Porcelain Switches - Butterfly Nut	33	Filé lamp holders	106	Wall Fixtures	210	CONTACTS	264
Porcelain Plugs and Junction boxes	34	Bakelite lamp holders	110	Cable clamps	212		
Large section cables	36	Ceramic lamp holder	112	Adjustable metal joint	213		
LUMET	39	Cement lamp holder	112	Extension pipes	214		
IP44 string lighting system		Porcelain lamp holders	113	Suspension lamp accessories	216		
String light lamp holder	40	SPOTLIGHTS	115	Other accessories	217		
String light lamp holder for lampshade	41	Tub-E14	116	CREATIVE FLEX	219		
String light accessories	42	GU1dO	118	Creative flexible extensions			
Flat Cables	45	CEILING ROSES	121	CAGE	227		
EIVA	47	Metal ceiling roses	122	Modular chandeliers			
IP65 Outdoor lighting system		Silicone ceiling roses	135				
EIVA System	48	Wooden ceiling roses	136				
EIVA-1 lamp holder	49	Porcelain ceiling roses	140				
EIVA-2 lamp holder	52	Ceramic ceiling roses	140				
EIVA-3 T-Joint	53	ROSE-ONE	143				
Outdoor EIVA Cables	55	Customizable ceiling rose					



SPOSTALUCE

**No matter the lamp, the layout or the setting...
the right answer is Spotaluce!**

Say goodbye to dark corners with the versatile Spotaluce.

Choosing the placement for ceiling and wall lamps can be a daunting task, and you may feel constrained by your existing sockets or light sources. That's where Spotaluce comes in, allowing you to effortlessly transform the lighting in your home. It's not only easy but also enjoyable, thanks to a wide selection of elegant and fun-colored textile cables.

All you need to do is connect the Spotaluce lamp plug to the nearest electrical socket and attach the lamp to your room's wall or ceiling. It couldn't be simpler!

EASY INSTALLATION

Save yourself the trouble of tearing down walls and hiring electricians.

FRESH LIGHT

A creative solution for introducing new lighting sources throughout your home.

100% CUSTOMIZABLE

Explore countless color and shape combinations.

Patented Solution
MADE IN ITALY

Follow this logo inside the
catalog and discover all the
components you can match

SPOSTALUCE

SPOSTALUCE E27

The Spostaluce E27 kit is the ideal solution for lovers of lighting design who wish to create a customized lighting installation in any environment, even where no light fixtures exist.



NEW

Wall or ceiling lamp holder

Cover Material: **Thermoplastic** CE

Rated Voltage/Power: **220-240V/12W** UK

Cables: **0,75-1,5mm²** CA

Fitting: **E27** MADE IN ITALY

Finish	Code
● White	KPL27L2FLPB
● Black	KPL27L2FLPN

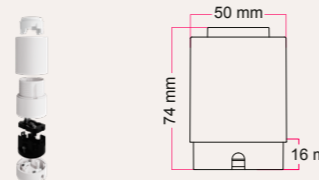

SPOSTALUCE



SPOSTALUCE E27 FOR LAMP SHADES

Crafted specifically for lampshades, this versatile Spostaluce E27 kit offers endless possibilities for custom illumination. It's the perfect solution for creating a personalized lighting arrangement on any wall or ceiling, even in spaces without existing light fixtures.

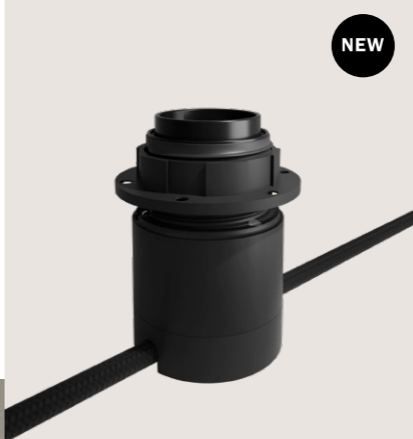

NEW

Wall or ceiling lamp holder for lampshade

Cover Material: **Thermoplastic** CE

Rated Voltage/Power: **220-240V/12W** UK

Cables: **0,75-1,5mm²** CA

Fitting: **E27** MADE IN ITALY

Finish	Code
● White	KPL27SF2FLPB
● Black	KPL27SF2FLPN

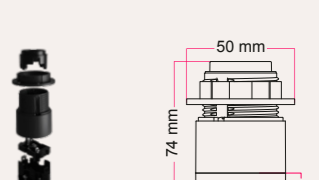

SPOSTALUCE



SPOSTALUCE S-14

The special Spotaluce esse14 Kit with an S14d lightbulb socket allows lighting design enthusiasts to bring the elegant modern style of these bulbs to places without existing lighting. Easily locate it to your preferred location, select your preferred cables, plug, and bulb, and connect to a power socket for endless custom installations.



Kit Spotaluce esse14 lamp holder

Cover Material: **Thermoplastic** CE

Cables: **0,75-1,5mm²** UK
CA

Rated Voltage/Current/Power: **250V/1A/20W**

Fitting: **S14d** MADE IN ITALY

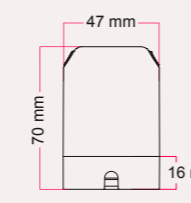

Finish	Code		Code
White	KPLS14D2FLPB	White marble effect	KPLS14D2FLPWM
Black	KPLS14D2FLPN	Brown marble effect	KPLS14D2FLPBM
Wenge effect	KPLS14D2FLPDW	Green marble effect	KPLS14D2FLPGM
Neutral	KPLS14D2FLPLW		

SPOTALUCE



Combine them and illuminate your imagination with endless possibilities

The distinctive feature of the Spotaluce system is its extreme versatility. It not only allows you to start from a basic power socket or a single light point to create lighting installations of any shape and size, but you can also combine them to achieve even more unique and customized compositions.



FILE

Decorate and light up your walls with the **File** Components.

Create, decorate and light up impressive lighting installations in **just a few steps**. **File** lets you forget about the difficulty and effort of wiring up a lamp holder!

Create **designs on the walls and ceilings** using electrical cables available in more than 20 colors and **Made in Italy** wooden components. Create effective lighting, tailored to your lighting and design requirements.

Build your customized and 100% Creative lighting solution!

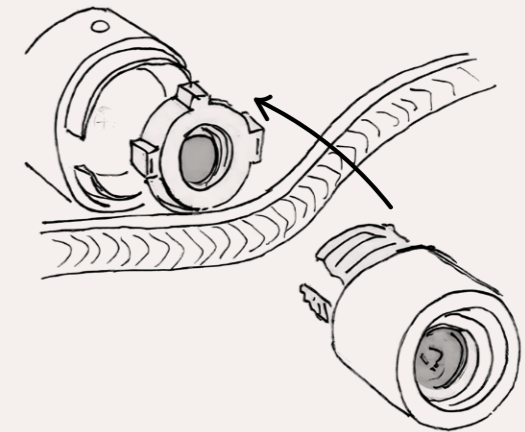

Patented Solution
MADE IN ITALY

FILÉ LAMP HOLDERS

Provide your pendant lighting the exact illumination you desire by choosing from a variety of lamps and lamp holders to connect to it. Opt for classic wooden lamp holders, either natural or painted, suitable for exposed bulbs or lampshades. Alternatively, you can pair your creation with the Tub-E14 spot lamp.



Filé system string light lamp holder

Material: **Wood** CE
UK
CA
 Rated Voltage/Current: **250V/4A**
 Compatible cables: **String lights 2x1,5 mm²**
 Fitting: **E27** MADE IN ITALY



Finish	Code
● White	BLCAT02
● Black	BLCAT03
● Neutral	BLCAT01

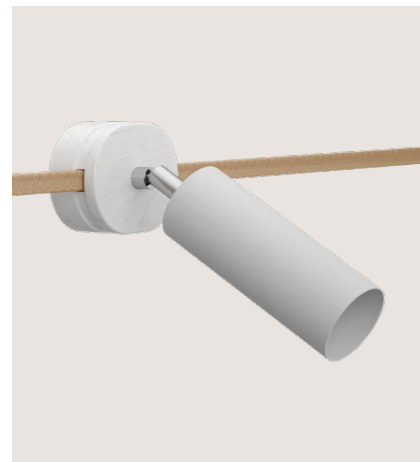

Filé system adjustable spotlight

Material: **Wood/Metal** CE
UK
CA
 Rose diameter: **120mm**
 Lampshade: **Tub-E14 metal pipe 60mm**
 Fitting: **E14 max 10W**

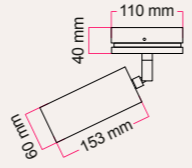

Finish	Code
● White	RLCAT32SPOT
● Black	RLCAT33SPOT



Filé system lamp holder for lampshade

Material: **Thermoplastic** CE
UK
CA
 Rated Voltage/Current: **250V/4A**
 Suitable lampshades: **40mm to 50mm**
 Fitting: **E27**

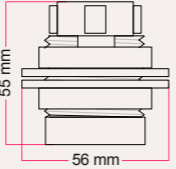

Finish	Code
● Black	PLC27PNTF



FILE ACCESSORIES

Create wall or ceiling lighting compositions by combining all the components of the Filé system. Utilizing wall fairlead, canopy and terminal blocks, you can design unique lighting solutions to enhance your interiors.

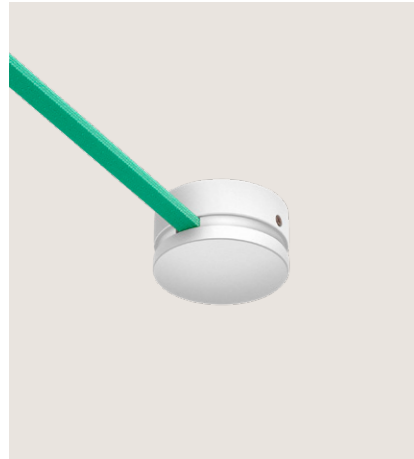

Filé system Canopy

Material: **Wood** CE UK CA
 Distance between fixing holes: **45mm**
 Compatible cables: **String lights 2x1,5 mm²**
 Upper Hole: **5mm** MADE IN ITALY

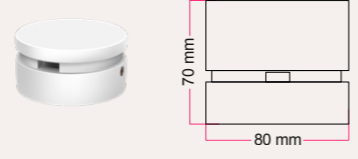

Finish	Code
White	RLCAT02
Black	RLCAT03
Neutral	RLCAT01

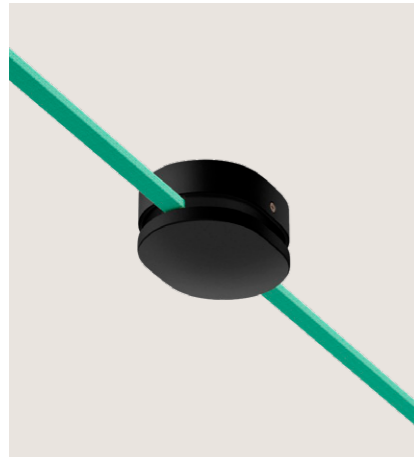

Filé system Oval canopy

Material: **Wood** CE UK CA
 Distance between fixing holes: **45mm**
 Compatible cables: **String lights 2x1,5 mm²**
 Upper Hole: **5mm** MADE IN ITALY

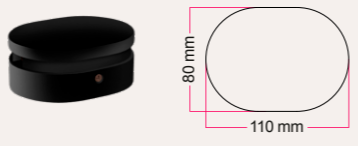

Finish	Code
White	RLCAT12
Black	RLCAT13
Neutral	RLCAT11

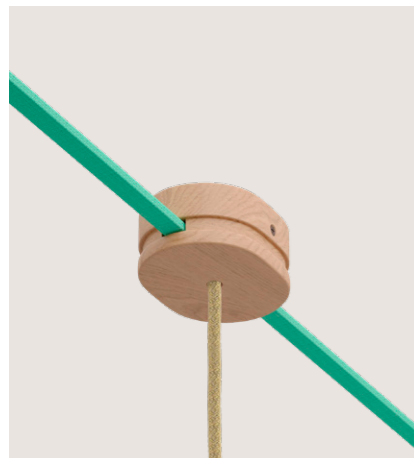

Filé system Oval Canopy

Material: **Wood** CE UK CA
 Distance between fixing holes: **45mm**
 Compatible cables: **String lights 2x1,5 mm²**
 Upper/Central hole: **5/10 mm** MADE IN ITALY



Finish	Code
White	RLCAT32
Black	RLCAT33
Neutral	RLCAT31





Filé system wall fairlead

Material: **Wood** CE UK CA
 Compatible cables: **String lights 2x1,5 mm²** MADE IN ITALY

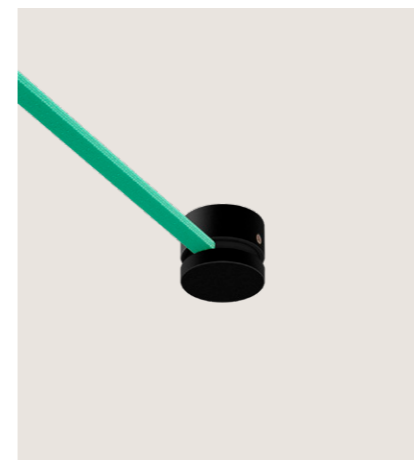

Finish	Code
White	PASLCAT02
Black	PASLCAT03
Neutral	PASLCAT01



Filé system Terminal block

Material: **Wood** CE UK CA
 Compatible cables: **String lights 2x1,5 mm²** MADE IN ITALY

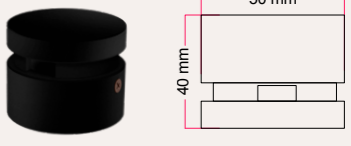

Finish	Code
White	TLCAT02
Black	TLCAT03
Neutral	TLCAT01

FLAT CABLES

These flat cables are Creative Cables solution allowing you to both create wonderful string-light for your garden parties and beautiful indoor designs. Choose from a selection of colors and add the Filé System accessories for your compositions.

Specifications:

H05RNH2-F 300/500 VAC Rectangular flat shaped 2x1,5mm² cable
 No flame propagation: in accordance with EN 60332-1-2/IEC 60332-1
 Referring Regulations: EN 50525-2-82 and IEC 60245

The cable is sold by the meter, multiple orders will be delivered in one piece up to a maximum of 25 meters in length.

MADE IN ITALY

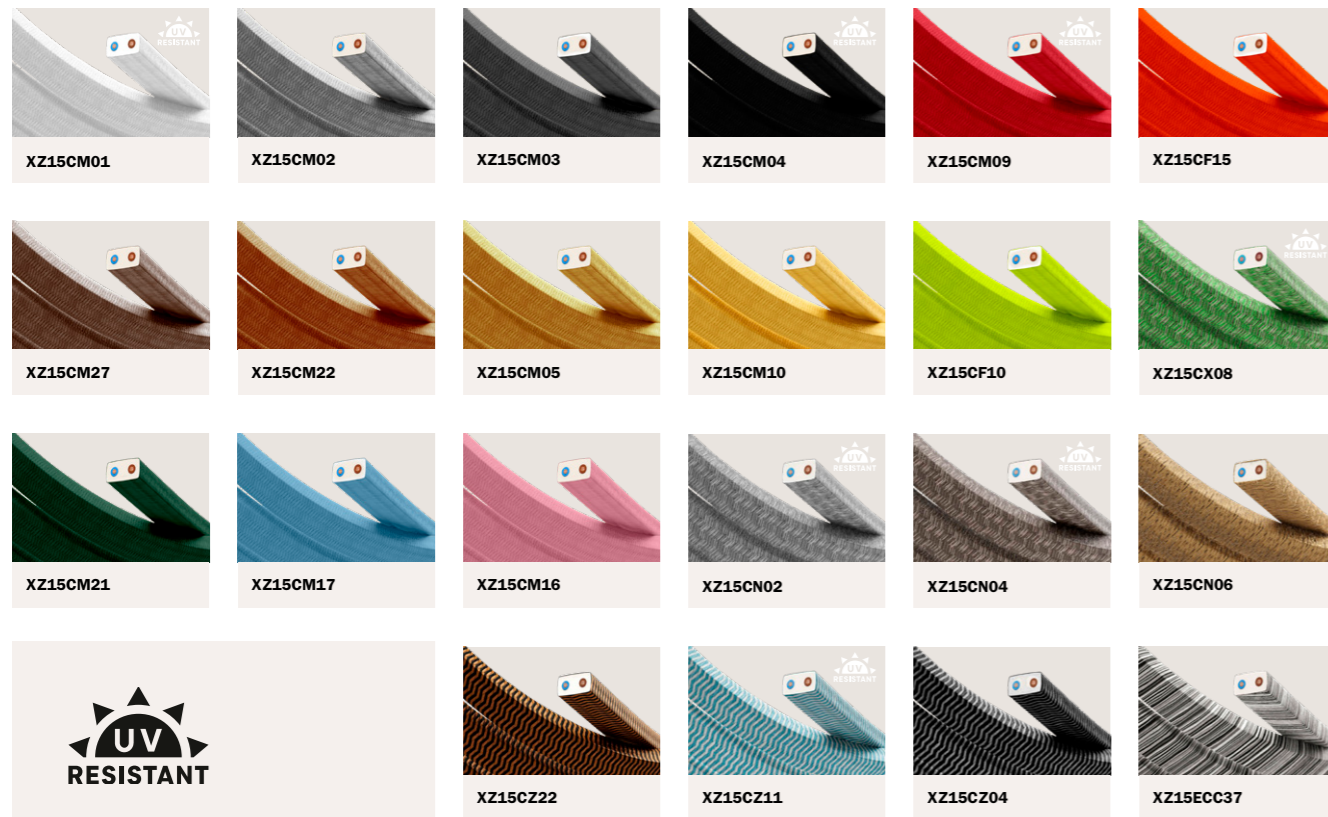
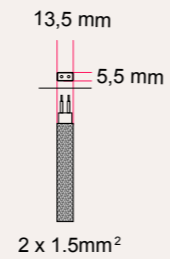

What does UV resistant cable mean?

It means the fabric used to line these cables was designed to resist UV rays, which make up around 10% of sunlight. The colour of UV resistant cables remains vibrant and doesn't tend to fade over time, even when they are consistently exposed to sunlight.



CREATIVE TUBES

Create your own personalized, visible wiring installation with **Tubes**.

Tubes are the Creative Cables system that combines the beauty of the fabric covering with the practicality of a true surface wall system.

The Tubes system eliminates the need for ugly plastic electrical conduits or rigid metal pipework.

Flexible

Creative-Tube combines the fabric-covered sheath with two metal filaments, allowing the conduit to maintain its shape when bent. It adapts to suit your needs.

Tailor-made

Create a beautiful and functional bespoke visible system that takes into account your daily needs and the style of your rooms.

Creative and safe

You have the freedom to exhibit your electrical system. Create a wall design that is a functional light source without sacrificing safety; the system adheres to the highest standards.



CREATIVE-TUBES

Creative-Tube is much more than just a fabric-covered conduit. Thanks to the metal filaments that run throughout its entire length, Creative-Tube can assume and maintain any shape you give it.

Creative-Tube is sold per meter, multiple orders will be delivered in one piece up to a maximum of 30 meters.

Specifications:

Classification No: **3321**
 Crushing Resistance: **>750N on 5cm at 20°C**
 Shock Resistance: **(-15°C) after applying 2 kg mass hammer**
 Internal material complies with **CEI-EN 61386-1 + EN 61386-22 Classification 3321**.
 Operating Temperature: **-5°C to +60°C**
 Resistance to flame propagation: **self-extinguishing V0**
 Dielectric strength: **<2000V A 50Hz**
 Insulation resistance: **>100 mega ohm**
 Diameter: **20mm**

CE
UK
CA

MADE IN ITALY

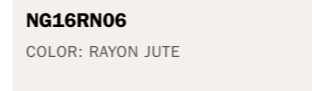
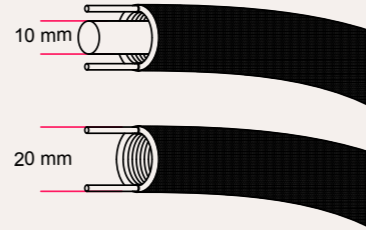

CREATIVE-TUBES TERMINALS

The metal terminals are essential accessories for connecting Creative-Tubes to junction boxes and metal cladding, enabling you to create captivating wall installations. They are constructed from metal with a zinc-plated finish.

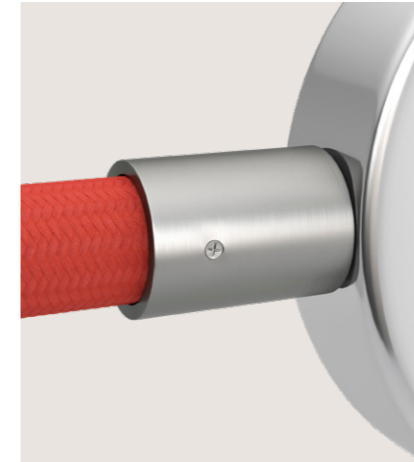

Creative-Tube Zinc-plated terminal

Material: **Metal with chrome-plated**
 Thread: **M10x1**
 Creative-Tubes: **20 mm**

CE
UK
CA

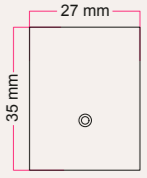

Finish Code

● Chrome

TERM6ZI

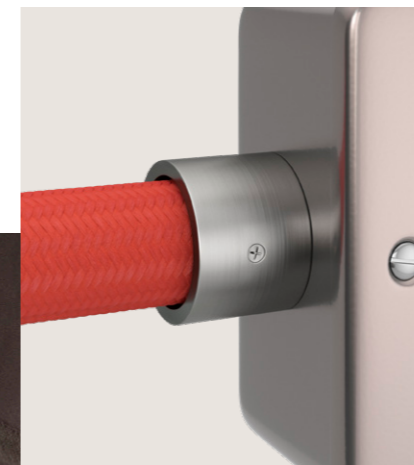

Creative-Tube Zinc-plated terminal

Material: **Metal with zinc-plated**
 Thread: **M20x1,5**
 Creative-Tubes: **20 mm**

CE
UK
CA

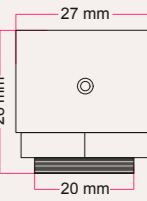

Finish Code

● Chrome

TERM3ZI

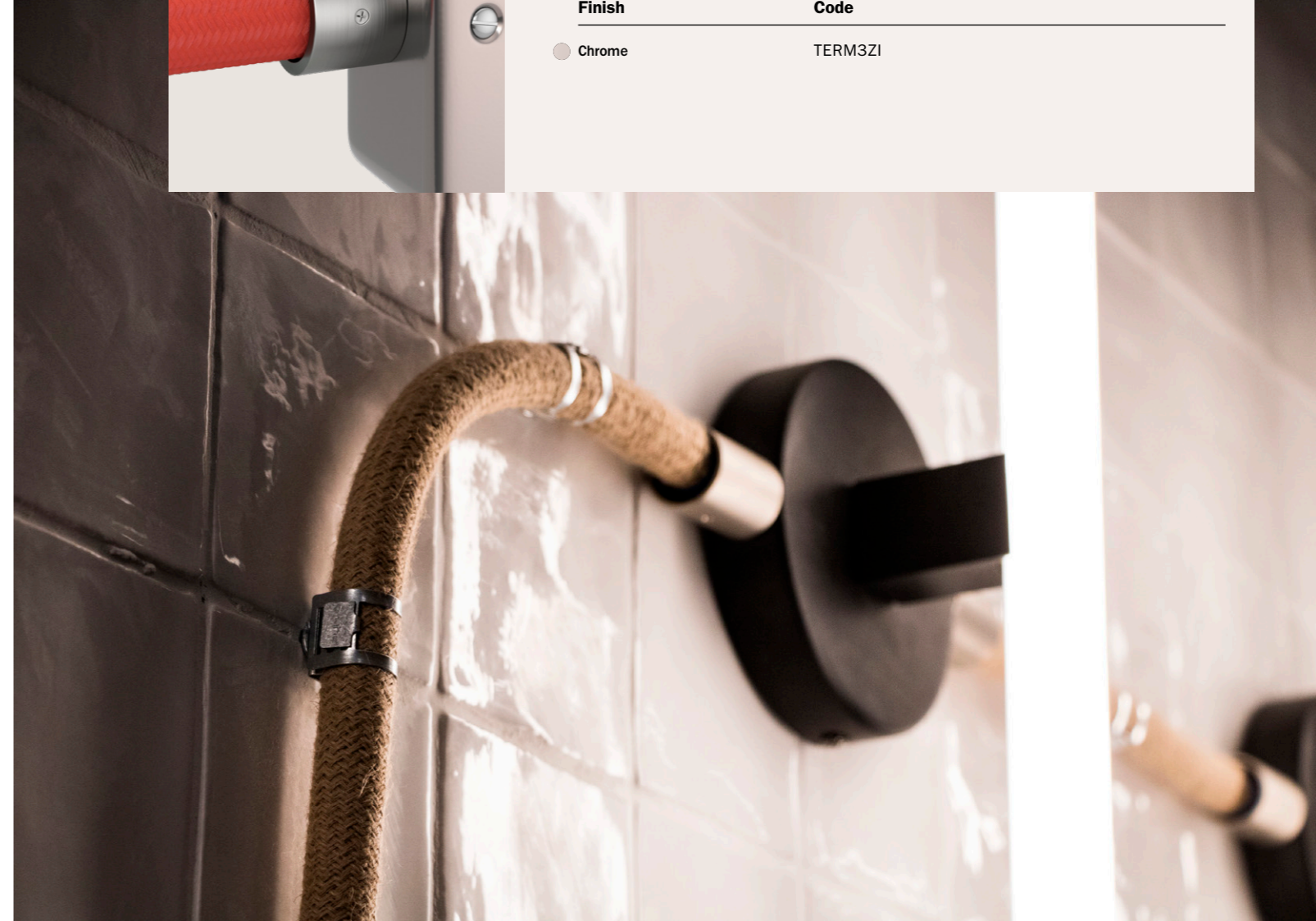

CREATIVE-TUBES BOXES

Junction box, box with switches or box with sockets: discover all the amazing possibilities offered by Creative-Tubes and select the accessories that best serve your creativity.

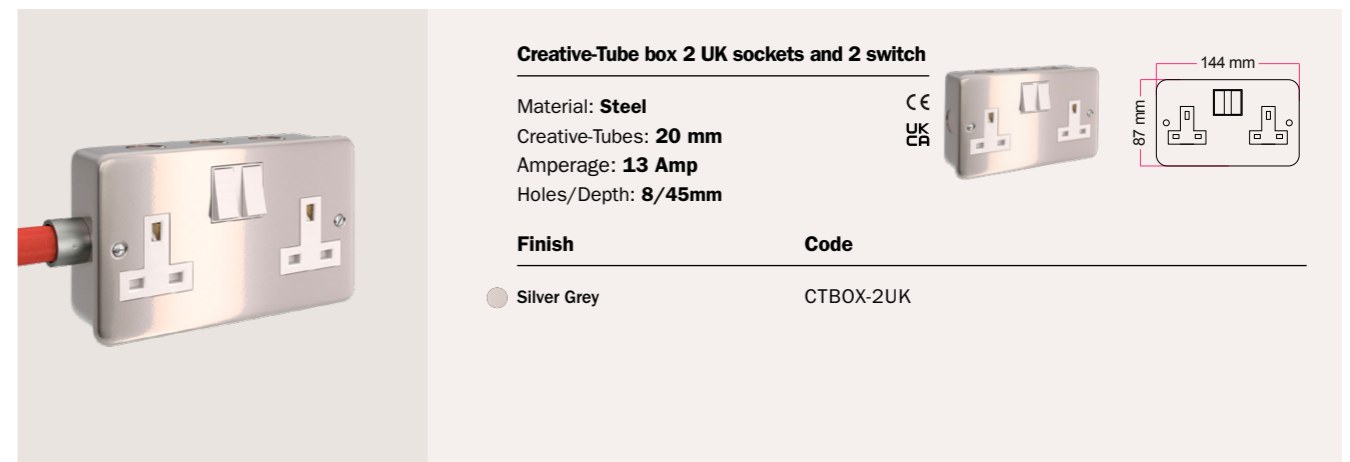
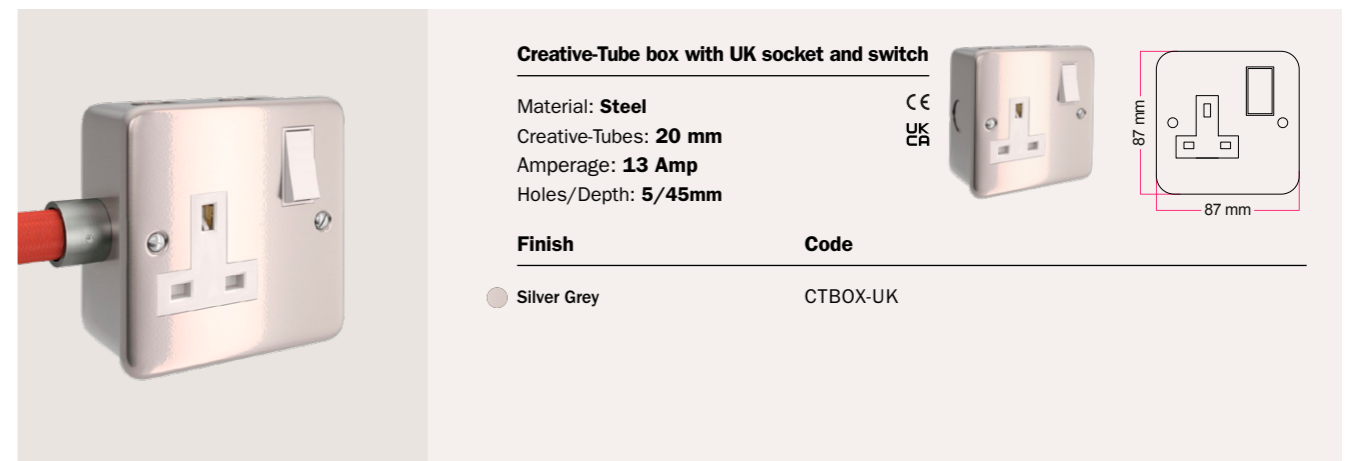
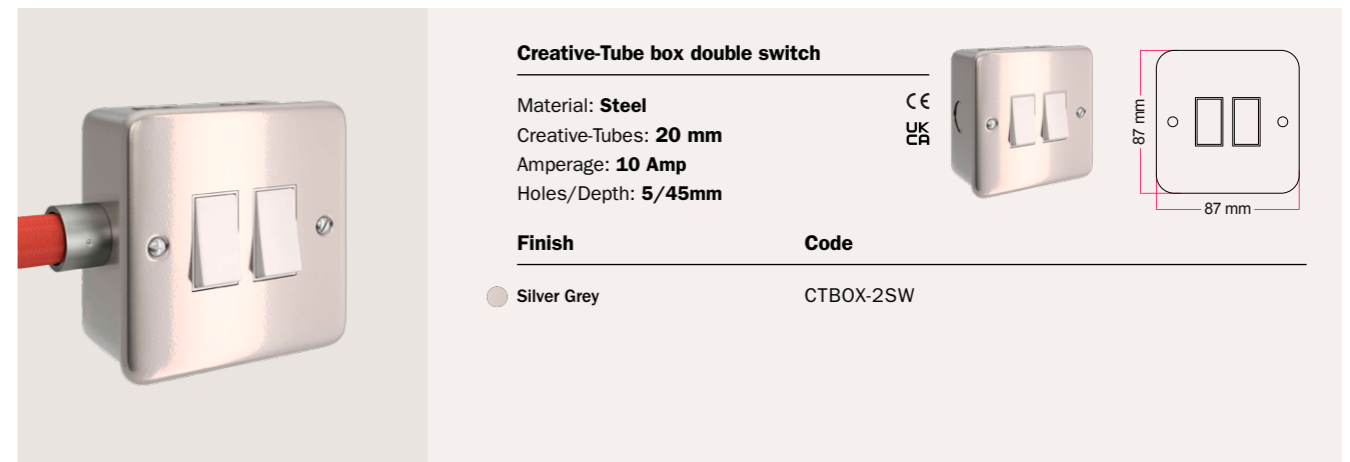
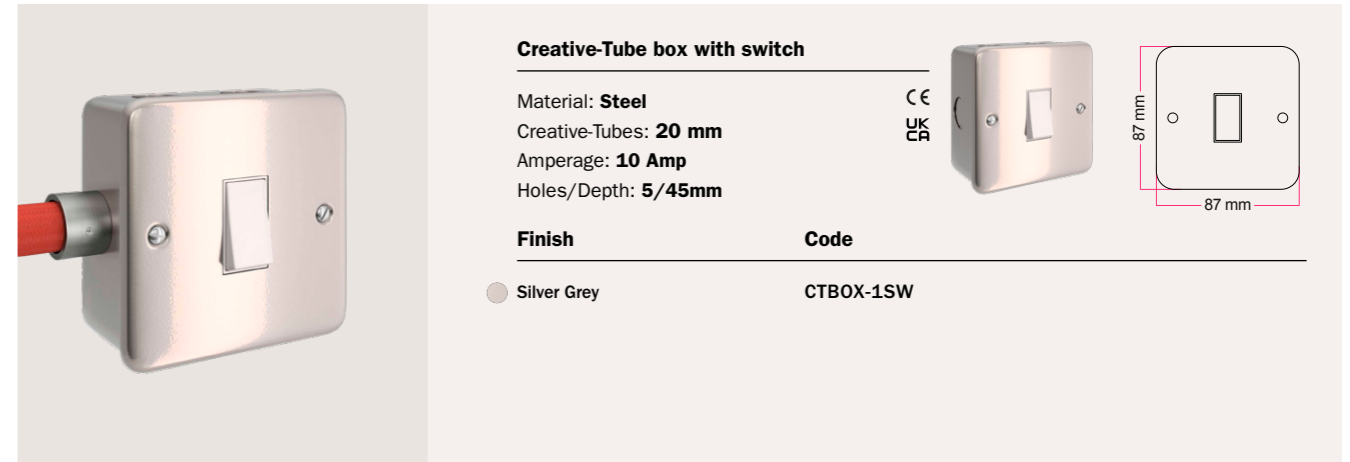
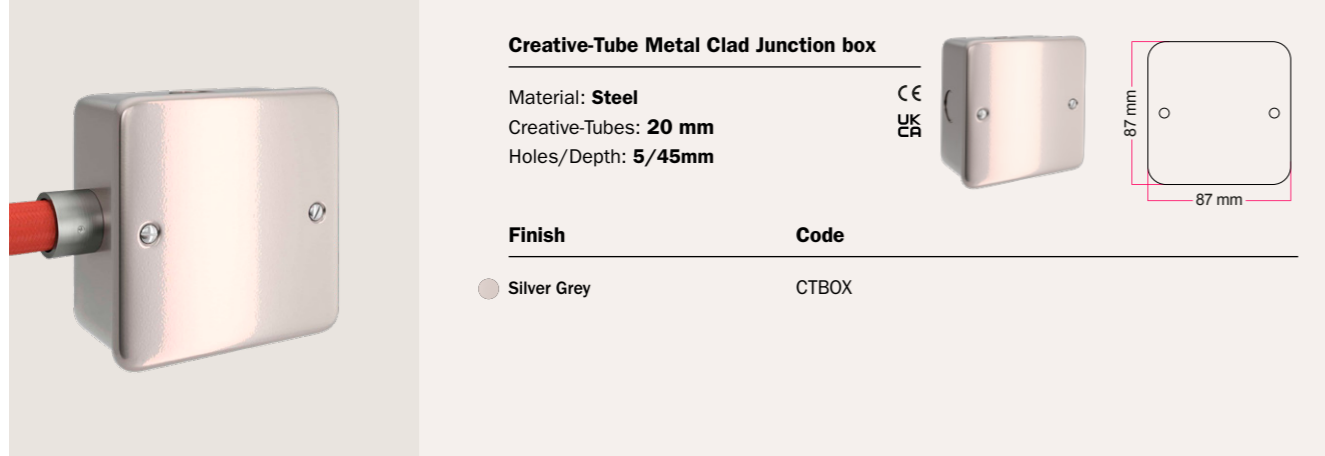



Creative-Tube box FR socket

Material: **Steel/Plastic**
 Creative-Tubes: **20 mm**
 Amperage: **16 Amp**
 Holes/Depth: **5/45mm**

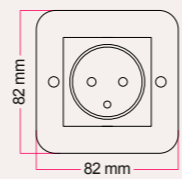

Finish

Code

● Silver Grey

CTBOX-FRA



Creative-Tube box with GER Schuko socket

Material: **Steel/Plastic**
 Creative-Tubes: **20 mm**
 Amperage: **16 Amp**
 Holes/Depth: **5/45mm**

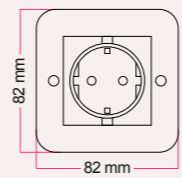

Finish

Code

● Silver Grey

CTBOX-GER



Creative-Tube box with 2 FR sockets

Material: **Steel/Plastic**
 Creative-Tubes: **20 mm**
 Amperage: **16 Amp**
 Holes/Depth: **8/45mm**

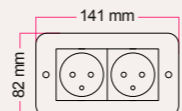

Finish

Code

● Silver Grey

CTBOX-2FRA



Creative-Tube box with 2 GER Schuko sockets

Material: **Steel/Plastic**
 Creative-Tubes: **20 mm**
 Amperage: **16 Amp**
 Holes/Depth: **8/45mm**

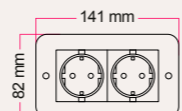

Finish

Code

● Silver Grey

CTBOX-2GER



Creative-Tube - T-shaped Junction box

Material: **Aluminium**
 Ingress Protection Rating: **IP55**
 ISO thread: **M20x1,5**
 Outlet: **3**

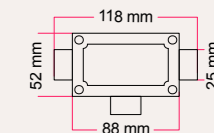

Finish

Code

● Aluminium

DER3-1



Creative-Tube X-Shaped Junction Box

Material: **Aluminium**
 Ingress Protection Rating: **IP55**
 ISO thread: **M20x1,5**
 Outlet: **4**

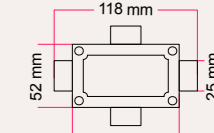

Finish

Code

● Aluminium

DER4-1

CREATIVE-TUBES CLIPS

With these clips, available in plastic or metal, using Creative-Tubes for your installations becomes even easier. They are suitable for fabric cables and easy to attach.

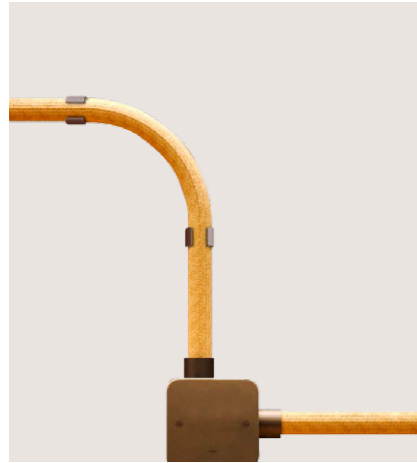

Creative-Tube - Metal adjustable cable clip

Material: **Plastic**
 Pull-out: **90 N**
 Creative-Tubes: **20 mm**

CE
 UK
 CA

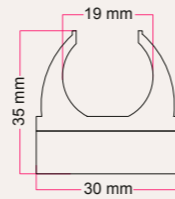

Finish

Code

● Light Grey

CLIPD20



Creative-Tube - Cable Clip

Material: **Steel**
 Creative-Tubes: **20 mm**

CE
 UK
 CA

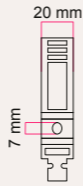

Finish

Code

● White

CTCLIPBI

● Black

CTCLIPNE





PORCELAIN SYSTEM

Smooth, dazzling, refined.

Porcelain is the undisputed queen in the field of interior design and decor with its material's unsullied elegance and technical qualities.

So it only felt natural to design a collection of stunning and high quality porcelain components to spruce up your electrical installations whilst avoiding invasive adjustments to your walls.

Compatible with
SPØSTALUCE

PORCELAIN SWITCHES - KNOB



The white porcelain diverter with knob is a vintage component used to control a single light from multiple locations. Made from high quality materials and perfected with an elegant finish, this diverter is ideal for those looking to achieve a vintage atmosphere in their home or office space.

NEW

Switch/Diverter in black with knob

Material: **Porcelain** CE UK CA
 Rated voltage/current: **250V/16A**
 Frequency: **50-60 Hz**
 Connection type: **Screw clamp**

Finish	Code
White	PBOXSW080BIABIA
Black	PBOXSW080BIANER
Red	PBOXSW080BIAROS

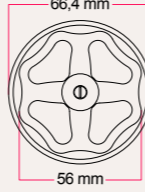

SPØSTALUCE

NEW

Switch/Diverter in black with knob

Material: **Porcelain** CE UK CA
 Rated voltage/current: **250V/16A**
 Frequency: **50-60 Hz**
 Connection type: **Screw clamp**

Finish	Code
White	PBOXSW080NERBIA
Black	PBOXSW080NERNER
Red	PBOXSW080NERROS

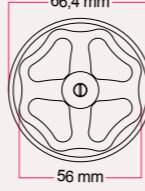
SPØSTALUCE

PORCELAIN SWITCHES - BUTTERFLY NUT



The black porcelain switch with butterfly nut is perfect to give that vintage touch to any exposed electrical installations. The butterfly nut is a unique product that really sets the whole system apart whilst giving it a fun retro look.

NEW

Switch/Diverter in black butterfly nut

Material: **Porcelain** CE UK CA
 Rated voltage/current: **250V/16A**
 Frequency: **50-60 Hz**
 Connection type: **Screw clamp**

Finish	Code
White	PBOXSW079BIABIA
Black	PBOXSW079BIANER
Red	PBOXSW079BIAROS

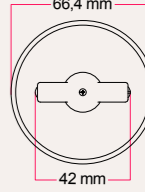

SPØSTALUCE

NEW

Switch/Diverter in black butterfly nut

Material: **Porcelain** CE UK CA
 Rated voltage/current: **250V/16A**
 Frequency: **50-60 Hz**
 Connection type: **Screw clamp**

Finish	Code
White	PBOXSW079NERBIA
Black	PBOXSW079NERNER
Red	PBOXSW079NERROS

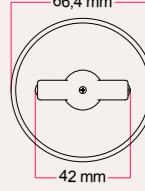



SPØSTALUCE



PORCELAIN PLUGS AND JUNCTION BOXES

The perfect choice for those seeking to install an exposed electrical conduit with a vintage aesthetic, all without sacrificing safety and efficiency. It distinguishes itself through its robustness, long-lasting durability, and a timeless, classic design that imbues it with the allure of authentic vintage lighting.



NEW

Schuko wall socket

Material: **Porcelain** CE
 Rated voltage/current: **250V/16A** UK
 Frequency: **50-60 Hz** CA
 Height: **50mm** ⊕

Finish **Code**

● White PBOXGERBIA
 ● Black PBOXGERNER

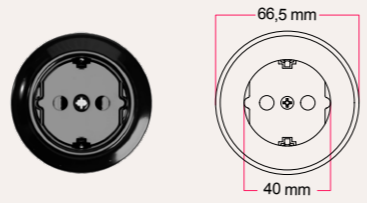

SPØSTALUCE



NEW

French wall socket

Material: **Porcelain** CE
 Rated voltage/current: **250V/16A** UK
 Frequency: **50-60 Hz** CA
 Height: **50mm** ⊕

Finish **Code**

● White PBOXFRABIA
 ● Black PBOXFRANER



SPØSTALUCE



NEW

Italian wall socket

Material: **Porcelain** CE
 Rated voltage/current: **250V/10-16A** UK
 Frequency: **50-60 Hz** CA
 Height: **50mm** ⊕

Finish **Code**

● White PBOXITABIA
 ● Black PBOXITANER

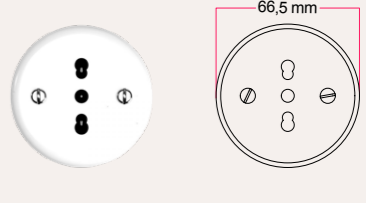

SPØSTALUCE



NEW

Junction box

Material: **Porcelain** CE
 Use: **Indoor** UK
 Height: **35mm** CA

Finish **Code**

● White PBOXBIA
 ● Black PBOXNER



SPØSTALUCE



NEW

Round porcelain 2-way base

Material: **Porcelain** CE
 Use: **Indoor** UK
 Height: **26mm** CA

Finish **Code**

● White PBASEINOUTBIA
 ● Black PBASEINOUTNER

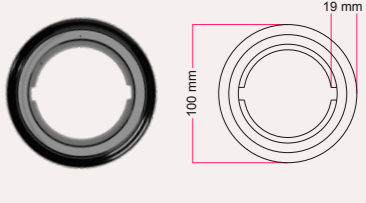

SPØSTALUCE



LARGE SECTION CABLES

Large round glossy-effect cables

Glossy-effect cables feature a sleek solid finish that is both elegant and casual. They can add color wherever it's desired.

Specifications:

H05VV-F 300/500VAC 3x1,50mm²
 Flex Round IMQ-HAR Cable DOUBLE INSULATION under textile braid.
 Standard reference: EN 50525-2-51.

The cable is sold by the meter, multiple orders will be delivered in one piece up to a maximum of 50 meters in length.

8,5 mm



3 x 1,50mm²

CE
UK
CA

MADE IN ITALY

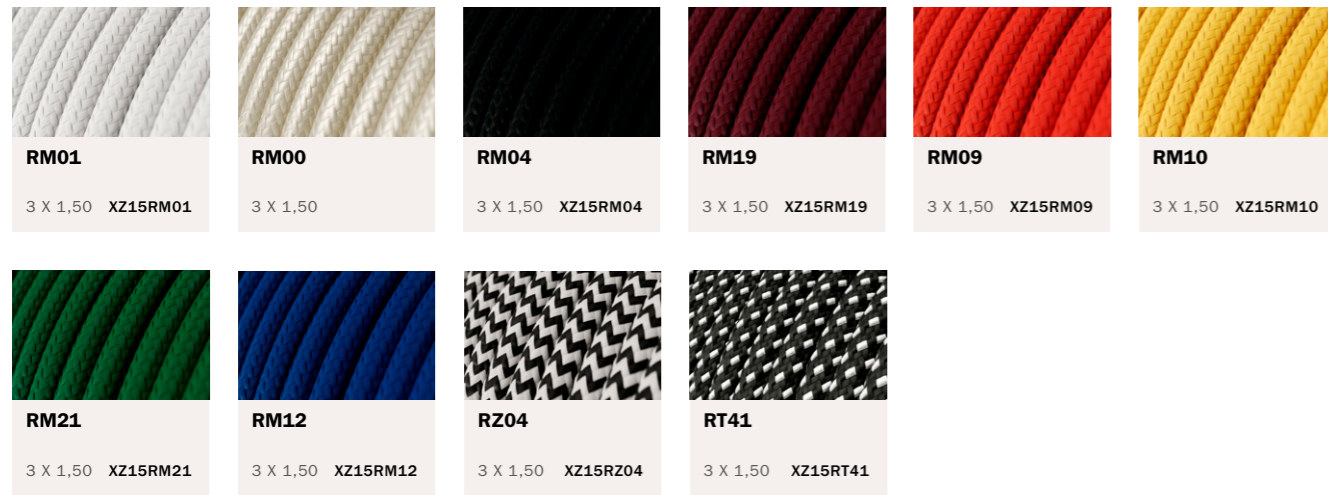

Large round natural fabric cables

These cables covered by Jute or linen are perfect to create extension cords, multi-sockets or to bring power to your electrical appliances, all while maintaining a natural style.

Specifications:

H05VV-F 300/500VAC 3x1,50mm²
 Flex Round IMQ-HAR Cable DOUBLE INSULATION under textile braid.
 Standard reference: EN 50525-2-51.

The cable is sold by the meter, multiple orders will be delivered in one piece up to a maximum of 50 meters in length..

8,5 mm



3 x 1,50mm²

CE
UK
CA

MADE IN ITALY

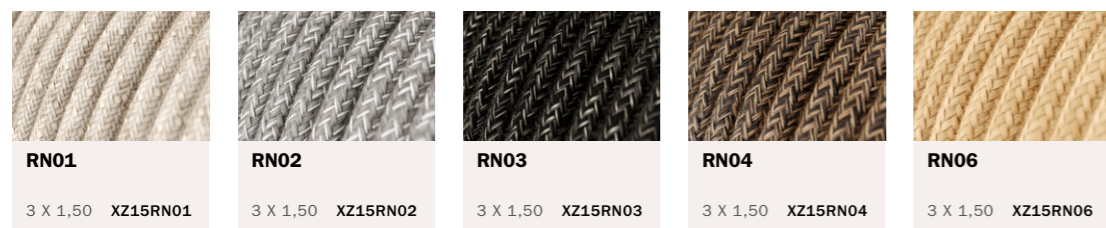

Large twisted glossy-effect cables

Featuring a unique twisted texture resembling braids, our glossy-effect cables offer a silky elegant finish.

Specifications:

300/300Vac 3x1,5mm²
 Flex Twisted Visible Spiral IMQ-HAR Cable DOUBLE INSULATION (additional transparent sheath), braided woven cloth textile sleeve.

The cable is sold by the meter, multiple orders will be delivered in one piece up to a maximum of 50 meters in length.

9 mm



3 x 1,50mm²

CE
UK
CA

MADE IN ITALY

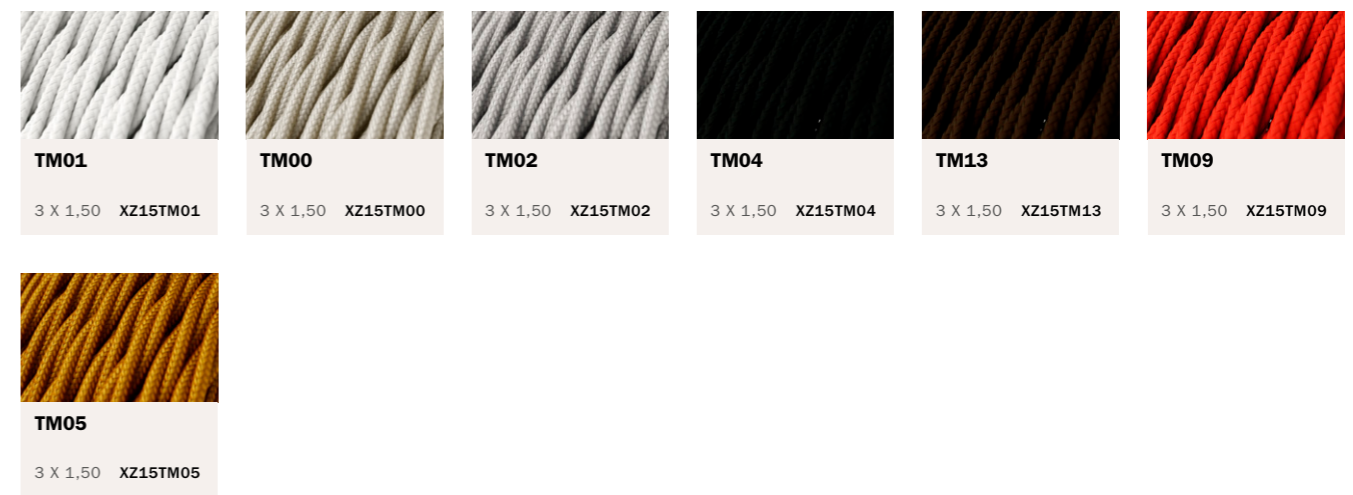

Large twisted natural cables

With their distinctive twisted texture and their covering in linen or jute, these electric cables create a natural and cozy ambiance in any space.

Specifications:

300/300Vac 3x1,5mm²
 Flex Twisted Visible Spiral IMQ-HAR Cable DOUBLE INSULATION (additional transparent sheath), braided woven cloth textile sleeve.

The cable is sold by the meter, multiple orders will be delivered in one piece up to a maximum of 50 meters in length.

9 mm



3 x 1,50mm²

CE
UK
CA

MADE IN ITALY

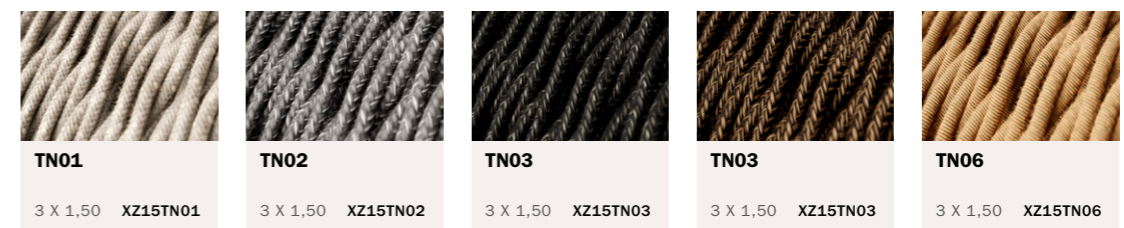



LUMET

Create a unique atmosphere with the **LUMET** components.

Light up your outdoor spaces for a special evening with the colorful

Creative Cables string light systems.

The Lumet components allows you to create **ready-to-use outdoor lighting** that is easy to install and dismantle. It is perfect for evenings spent outdoors with your friends, at home or on holiday!

The IP44 protection classification means that you can install the Lumet string lights in your outdoor spaces, even during the most humid evenings, and quickly take them down before each downpour.

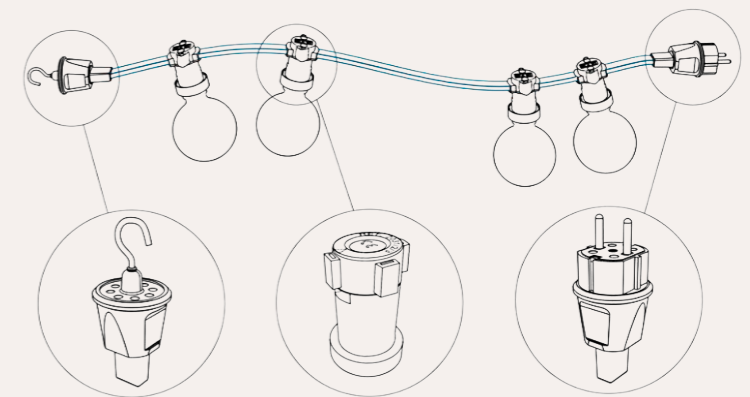

Patented Solution
MADE IN ITALY

STRING LIGHT LAMP HOLDER

This thermoplastic E27 lamp holder is specifically designed to autonomously compose your Lumet string lights. It can be placed on the string lighting cable at the exact points where you want to illuminate.



Lumet string lights lamp holder

Cover Material: **Thermoplastic**
 Rated Voltage/Current: **250V/4A**
 Compatible Cables: **2x1,5mm²**
 Fitting: **E27**

CE
UK
CA

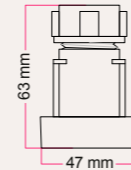

Finish

Code

● Black

PLC27TPN19

💧 IP44 WATER RESISTANT

STRING LIGHT LAMP HOLDER FOR LAMPSHADE

This E27 threaded thermoplastic lamp holder is designed to enable you to easily and independently assemble your string lights, giving you the possibility to hang a lampshade and make your spaces even more special.



Lumet double ferrule lamp holder for lampshade

Cover Material: **Thermoplastic**
 Rated Voltage/Current: **250V/4A**
 Hole diameter: **Between 40mm and 50mm**
 Fitting: **E27**

CE
UK
CA

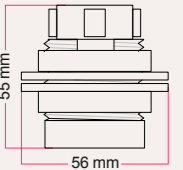

Finish

Code

● Black

PLC27PNTF

💧 IP44 WATER RESISTANT

STRING LIGHT ACCESSORIES

Schuko Plugs, hooks, wall fairlead, adaptors: everything you need to complete your string light and illuminate gardens, gazebos and terraces.





Lumet FR-GER Plug

Material: **Thermoplastic** CE
 Rated Voltage/Current: **250V/16A** UK
 Pole: **2 poles with earth** CA

Finish ⊕

Finish	Code
● Black	SPCATFRN

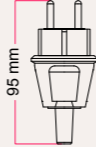
IP44 WATER RESISTANT

Lumet Hook

Material: **Thermoplastic + galvanized metal** CE
UK
CA

Finish

Finish	Code
● Black	TERGCATN

IP44 WATER RESISTANT

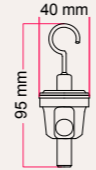



Lumet wall fairlead

Material: **Metal** CE
 Qty: **10 pcs** UK
CA

Finish

Finish	Code
● Metal	PC10FCATM01

IP44 WATER RESISTANT

Lumet adaptors for round and flat cables

Junction: **Plastic** CE

Finish

Finish	Code
● Black	CON01

IP44 WATER RESISTANT

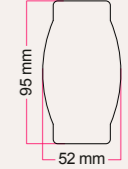
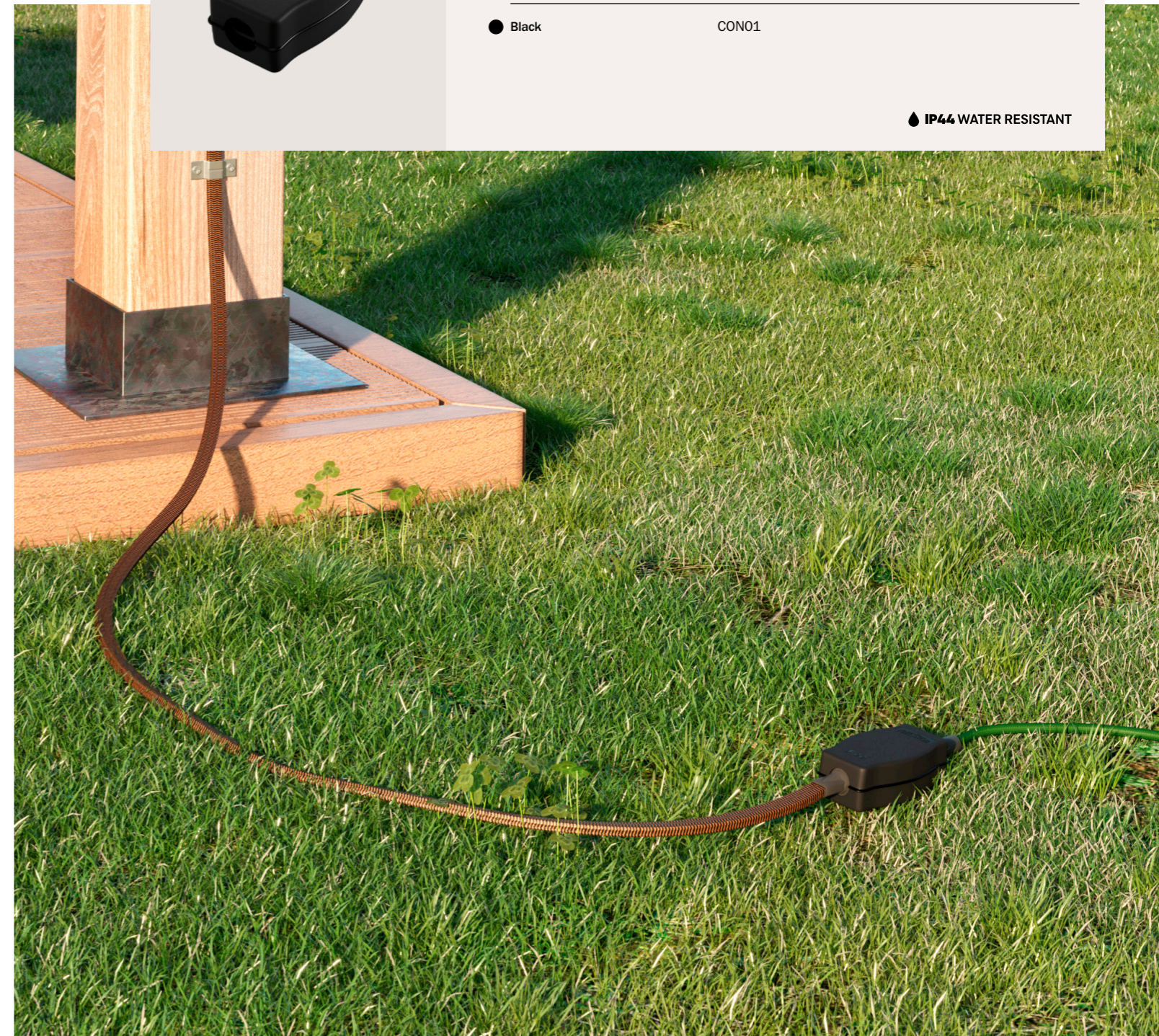

FLAT CABLES

Flat cables are Creative Cables solution allowing you to both create wonderful string-light for your garden parties and beautiful outdoor designs through the Lumet System. Choose from a selection of colors and add the necessary accessories for your compositions.

Specifications:

H05RNH2-F 300/500 VAC Rectangular flat shaped 2x1,5mm² cable
 No flame propagation: in accordance with EN 60332-1-2/IEC 60332-1
 Referring Regulations: EN 50525-2-82 and IEC 60245

The cable is sold by the meter, multiple orders will be delivered in one piece up to a maximum of 25 meters in length.



MADE IN ITALY

13,5 mm

5,5 mm



2 x 1.5mm²

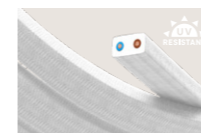

XZ15CM01

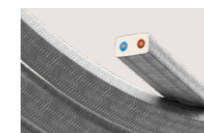

XZ15CM02

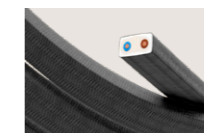

XZ15CM03

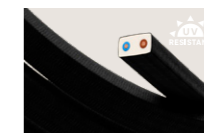

XZ15CM04

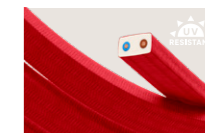

XZ15CM09

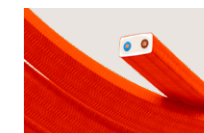

XZ15CF15

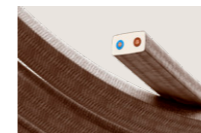

XZ15CM27

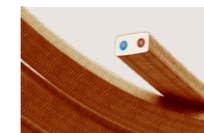

XZ15CM22

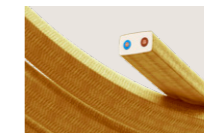

XZ15CM05

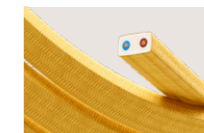

XZ15CM10



XZ15CF10

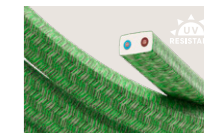

XZ15CX08

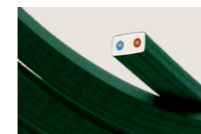

XZ15CM21

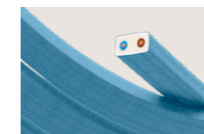

XZ15CM17

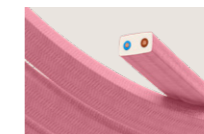

XZ15CM16

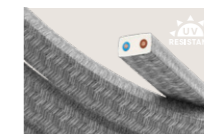

XZ15CN02

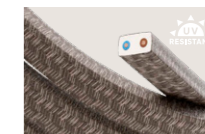

XZ15CN04

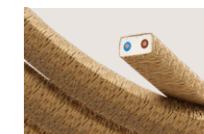

XZ15CN06

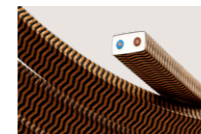

XZ15CZ22

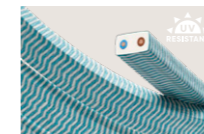

XZ15CZ11

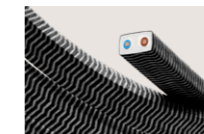

XZ15CZ04

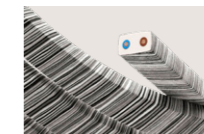

XZ15ECC37



What does UV resistant cable mean?

It means the fabric used to line these cables was designed to resist UV rays, which make up around 10% of sunlight. The colour of UV resistant cables remains vibrant and doesn't tend to fade over time, even when they are consistently exposed to sunlight.

EIVA COMPONENTS

EIVA: the first do-it-yourself IP65 Outdoor lighting system.
Water has never been a natural environment for light.

Until today.

Create your own water, rain and storm resistant lamp with
guaranteed Creative Cables quality.

Patented Solution
DESIGN IN ITALY

 **EIVA**
OUTDOOR IP65

EIVA SYSTEM

The heart of EIVA is the world's first wired E27 IP65 lamp holder: thanks to the insulating gel inside and a watertight membrane on the bulb, this lamp holder withstands rain and storms in complete safety.

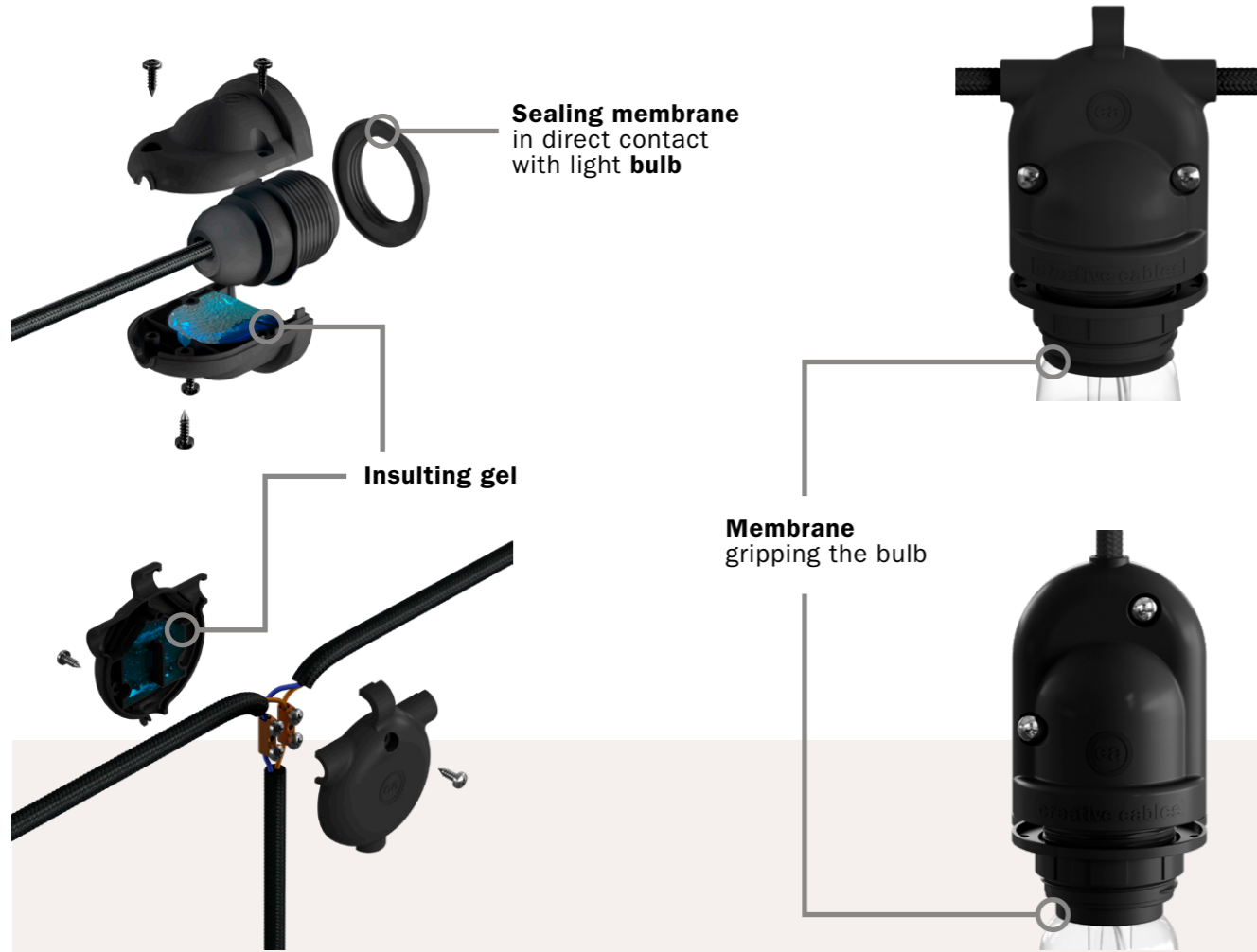

DESIGNED FOR OUTDOOR, PERFECT FOR INDOOR.

The EIVA Outdoor IP65 System will allow you to illuminate outdoor spaces like gardens, patios and terraces but also as lighting solution for the bathroom, without having to worry about water splashes.



EIVA-1

The first outdoor E27 IP65 wirable lamp holder

Made of thermoplastic, this water resistant lamp holder is suitable for both light bulbs and lampshades with E27 connection and can be purchased in its "naked" version or in a kit, complete with a soft touch silicone cover.

Thanks to a special insulating gel contained inside and a hermetically sealing membrane that rests on the bulb, this lamp holder can safely endure rain and storms.

Compatible with:
Cables only 2x1mm² H05RN-F
Bulbs A60, ST64, G95 and G125 shapes that guarantee rating of IP65 protection

EIVA wirable lamp holder	
Cover Material: Thermoplastic	CE
Rated Voltage/Current: 250V/4A	UK
Cable Clamp: Integrated	CA
Fitting: E27	
Finish	Code
● White	PL27PBEIVA
● Black	PL27PNEIVA

UL Listed E26 socket is also available

IP65 WATERPROOF



EIVA-1 lamp holder with silicone covers

EIVA-1, the first outdoor E27 IP65 wirable lamp holder, can be purchased with a soft touch silicone cover, available in two different shapes and many colour variations: perfect for any type of suspension or wall lamp.

Compatible with:

Cables only 2x1mm² H05RN-F

Bulbs A60, ST64, G95 and G125 shapes that guarantee rating of IP65 protection



EIVA Pastel lamp holder

Cover Material: **Soft touch silicone** CE
 Rated Voltage/Current: **250V/4A** UK
 Cable Clamp: **Integrated** CA
 Fitting: **E27**

Finish	Code
● Black	KEIVAPABK
● Soft blue	KEIVAPASB
● Soft green	KEIVAPAVE
● Mustard yellow	KEIVAPAMU
● Salmon	KEIVAPASAL

UL Listed E26 socket is also available

IP65 WATERPROOF

EIVA Elegant lamp holder

Cover Material: **Soft touch silicone** CE
 Rated Voltage/Current: **250V/4A** UK
 Cable Clamp: **Integrated** CA
 Fitting: **E27**

Finish	Code
● White	KEIVAELO1BI
● Black	KEIVAELO1BK
● Glacier Grey	KEIVAELO1GG
● Petrol	KEIVAELO1PE

UL Listed E26 socket is also available

IP65 WATERPROOF

EIVA-1 lamp holder with silicone covers for lampshades

Complete with soft touch silicone cover available in three colours, this lamp holder with double ferrule is water resistant and is suitable for any lampshade with an E27 connection: choose from more than 100 models available in our assortment.

Compatible with:

Cables only 2x1mm² H05RN-F

Bulbs A60, ST64, G95 and G125 shapes that guarantee rating of IP65 protection



EIVA Elegant lamp holder for lampshades

Cover Material: **Soft touch silicone** CE
 Rated Voltage/Current: **250V/4A** UK
 Cable Clamp: **Integrated** CA
 Fitting: **E27**

Finish	Code
● White	KEIVAELO2BI
● Black	KEIVAELO2BK

UL Listed E26 socket is also available

IP65 WATERPROOF

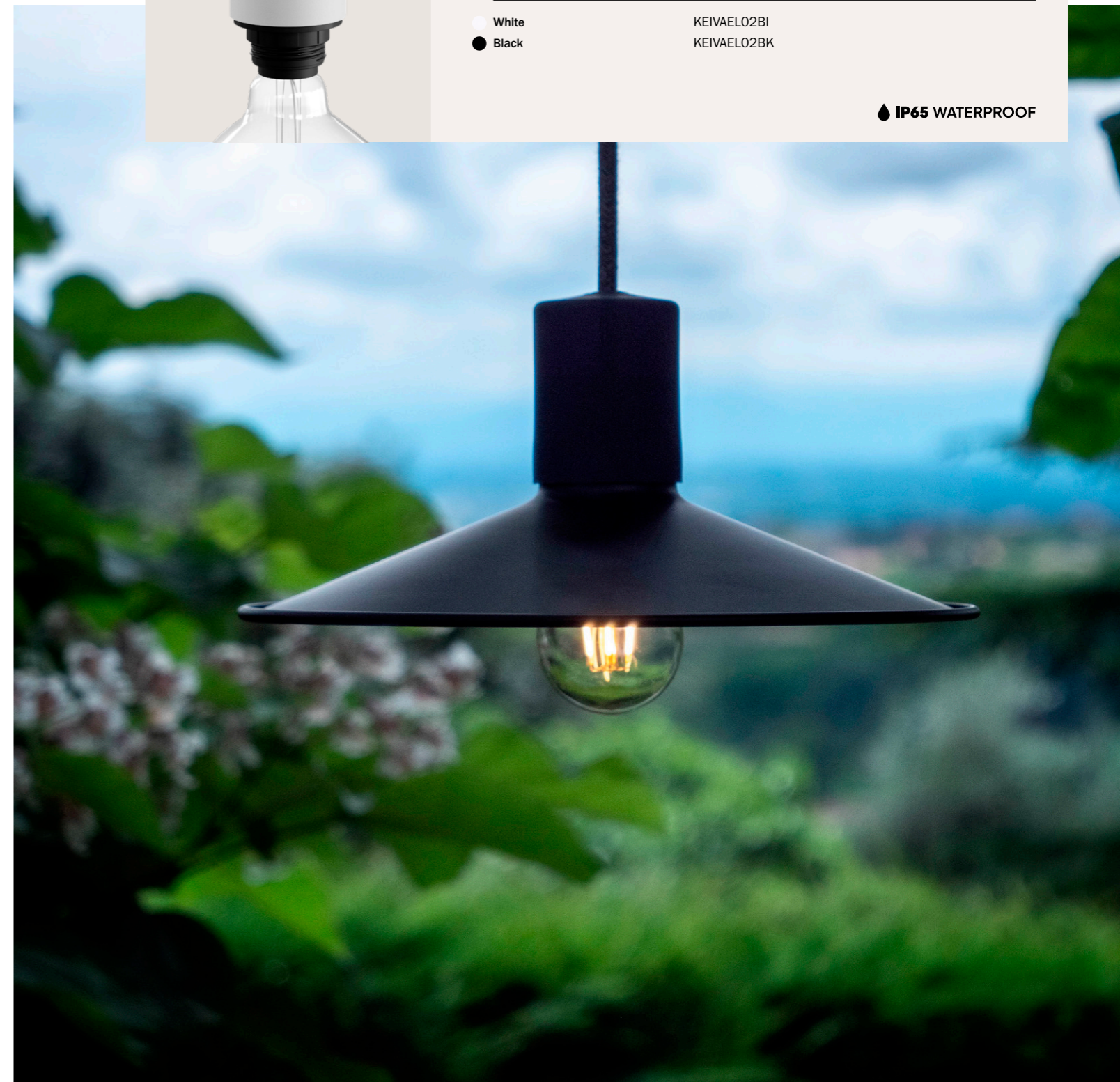

EIVA-2 LAMP HOLDER

Patented solution

EIVA-2 is the 2-way IP65-rated lamp holder from EIVA outdoor range. With this lamp holder you will be free to choose the number of light points you really need, vary their distance and match your preferred cable colour. This is suitable for both a naked bulb and lampshade configurations.



Compatible with:
Cables only 2x1mm² H05RN-F
Bulbs A60, ST64, G95 and G125 shapes that guarantee rating of IP65 protection



EIVA-2 lamp holder

Cover Material: **Thermoplastic** CE

Rated Voltage/Current: **250V/4A** UK

Cable Clamp: **Integrated** CA

Fitting: **E27**

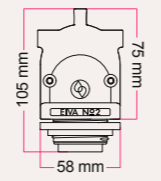
UL Listed E26 socket is also available

Finish	Code
● White	PL27PBEIVA2
● Black	PL27PNEIVA2

IP65 WATERPROOF

EIVA-3 T-JOINT

Patented solution

EIVA-3 is the T-joint that allows you to design multiple outdoor configurations. By using the existing connections of your installation, you can create pendant lamps with a naked bulb or lampshade, or create a light grid by crossing them. Thanks to the caps included in the kit, EIVA-3 can also be used as a terminal. Using the ring on the top you you can attach the joint to any space.

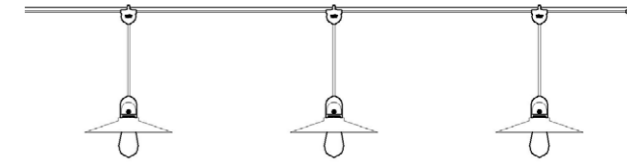

Compatible with:
Cables only 2x1mm² H05RN-F



EIVA-3

Cover Material: **Thermoplastic** CE

Rated Voltage/Current: **110 - 240V/4A** UK

Cable Clamp: **Integrated** CA

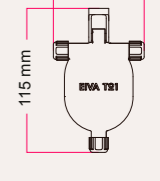
Finish	Code
● White	GTPBEIVA
● Black	GTPNEIVA
● Mustard yellow	GTPMUEIVA
● Soft green	GTPVEEIVA

IP65 WATERPROOF



Ceiling Rose

Thanks to the special insulating gel contained in the dedicated box, the EIVA ceiling rose - as well as the lamp holder that is the heart of the system - can be used to create suspension lamps with IP65 degree of protection. Made of soft-touch silicone, this product offers a smooth and elegant finish and is available in a variety of color options.

Compatible with:

Cables only 2x1mm² H05RN-F



EIVA Cylindrical outdoor ceiling rose

Cover Material: **Soft touch silicone**
 Hole diameter: **10mm**
 Cable Clamp: **included**

CE
UK
CA

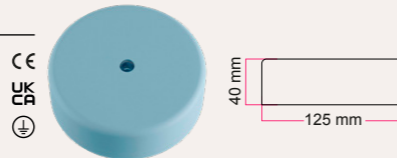

Finish	Code	Finish	Code
White	KEIVAROSBI	Soft blue	KEIVAPASB
Black	KEIVAROSBK	Soft green	KEIVAROSVE
Glacier Grey	KEIVAROSGG	Mustard yellow	KEIVAPAMU
Petrol	KEIVAROSPE	Salmon	KEIVAPASAL

IP65 WATERPROOF



Schuko IP44 plug

This black plastic Schuko plug may be used to create lighting with outdoor cables and EIVA system components. The IP44 protection rating of this plug means it's protected against splashes and spray.



Black Schuko plug with ring

Material: **Technopolymer**
 Voltage: **250 V**
 Rated Current: **16A**
 Poles: **2P+T**

CE
UK
CA



Finish	Code
Black	80052

IP44 WATER RESISTANT

OUTDOOR EIVA CABLES

The EIVA outdoor cables are 100% Made in Italy and IMQ-HAR certified, guaranteeing safety, flexibility, and weather resistance. These cables are designed to be compatible with the EIVA IP65 Outdoor System, which is a waterproof and rain-resistant lighting system.









Specifications:

H05RN-F 300/500VAC 2x1mm²
 Rubber sheathed flexible round IMQ-HAR Cable DOUBLE INSULATION under textile braid.

The cable is sold by the meter, multiple orders will be delivered in one piece up to a maximum of 50 meters in length.

MADE IN ITALY



 SM01 2 X 1,00 XZ2SM01	 SM04 2 X 1,00 XZ2SM04	 SM09 2 X 1,00 XZ2SM09	 SN04 2 X 1,00 XZ2SN04
 SN02 2 X 1,00 XZ2SN02	 SN06 2 X 1,00 XZ2SN06	 SX08 2 X 1,00 XZ2SX08	 SZ11 2 X 1,00 XZ2SZ11



What does UV resistant cable mean?

It means the fabric used to line these cables was designed to resist UV rays, which make up around 10% of sunlight. The colour of UV resistant cables remains vibrant and doesn't tend to fade over time, even when they are consistently exposed to sunlight.



THE ORIGINAL CREATIVE CABLES

Some call them colourful textile cables, others fabric covered cables, whilst others still simply call them coloured cables. But really, for over 10 years their real name has been Creative Cables.

What makes Creative Cables products so special?

Made in Italy

From the industrial process behind the PVC cables to the fine work of tailoring that goes into the textile linings, every single Creative Cables component is Made in Italy. Including the design, obviously!

Quality

First and foremost! Our cable specifications, fully compliant with the strict HAR and UL regulations, are constantly monitored and consistently kept up to date. The fabric used for the finish comes in one-of-a-kind colour hues from the best Italian suppliers.

Flexibility

Our PVC cable has been produced based on a special formula that maximises flexibility and prevents bulges. The complete cable is Creative Cables guaranteed from the surface to the core of the product.

Our selection

Which boasts the vastest colour catalogue in the world. Different fabrics, from polyester to linen, cotton to jute, combined with various textures plus exclusive and patented designs. On top of all of this we offer stunning solutions like the Marlene line, soft and light like a feather.

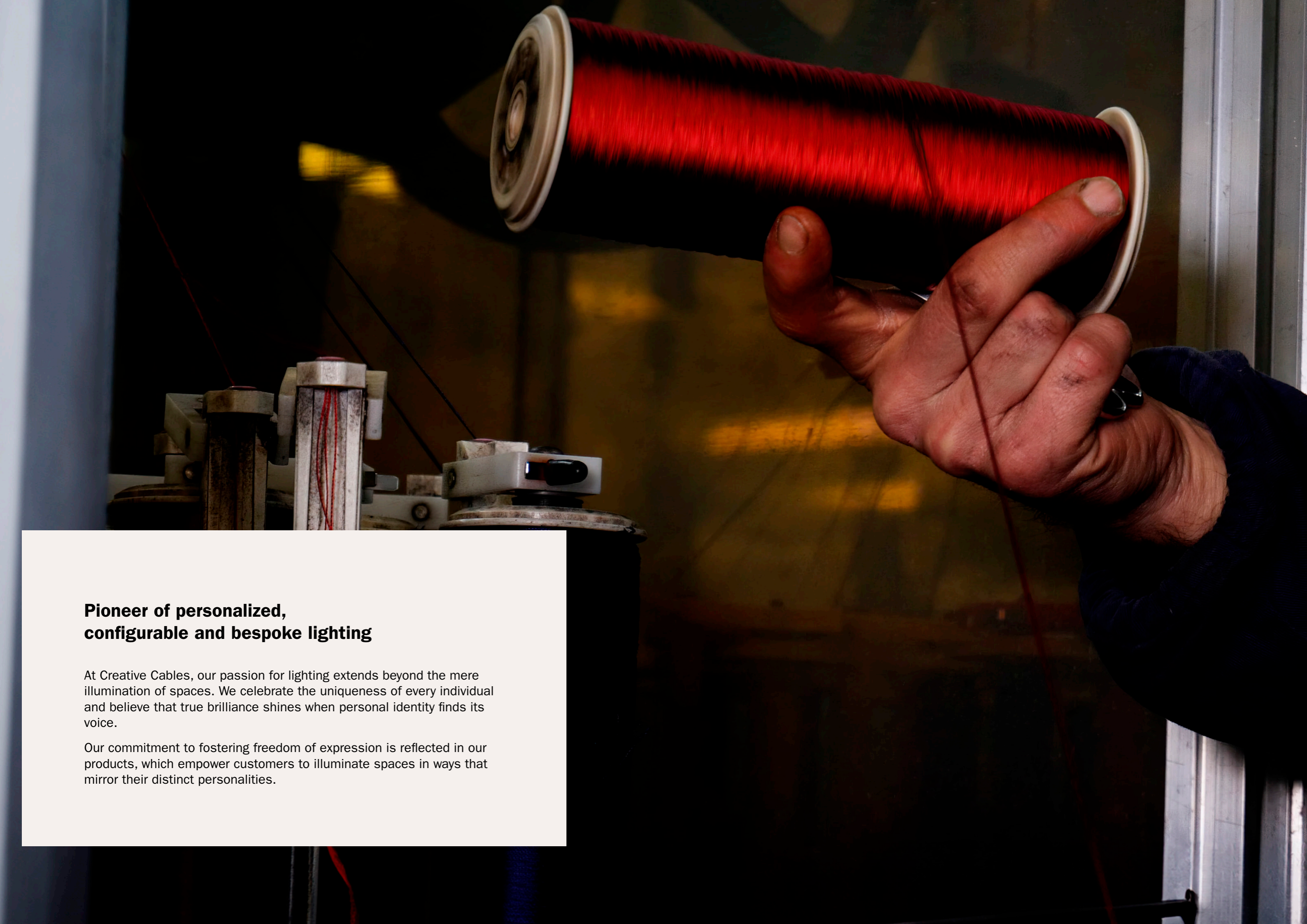

**Pioneer of personalized,
configurable and bespoke lighting**

At Creative Cables, our passion for lighting extends beyond the mere illumination of spaces. We celebrate the uniqueness of every individual and believe that true brilliance shines when personal identity finds its voice.

Our commitment to fostering freedom of expression is reflected in our products, which empower customers to illuminate spaces in ways that mirror their distinct personalities.

LIGHTING CABLES

More than 300 colours, patterns, textures and surface effects for different uses, tastes or designs. Choose among the offered styles (round, twisted, nautical, large section or flat) to select what best suits your lighting project: they are incredibly flexible, because we use high quality PVC to avoid bulges or wrinkles. All of our lighting cables are IMQ-HAR certified, the highest quality standard in Europe.

Round glossy-effect cables

Glossy cables have a bright solid finish, which is elegant yet informal. Shiny as silk, they can bring colour wherever needed.

Specifications:

H03VV-F 300/300VAC 2x0,75mm² or 3x0,75mm²
Flex Round IMQ-HAR Cable DOUBLE INSULATION under textile braid.

CE

The cable is sold by the meter, multiple orders will be delivered in one piece up to a maximum of 50 meters in length.
UL listed 3 core AWG18 cable is also available

MADE IN ITALY

6,2 mm



2 x 0.75mm²

6,6 mm



3 x 0.75mm²



Round cotton cables

Our cotton cables come in both pastel colours and warm tones. Cotton has a natural look and matches cozy and minimal environments. Ideal for those who prefer a "raw" feeling.

Specifications:

H03VV-F 300/300VAC 2x0,75mm² or 3x0,75mm² Flex Round IMQ-HAR Cable DOUBLE INSULATION under textile braid. CE

The cable is sold by the meter, multiple orders will be delivered in one piece up to a maximum of 50 meters in length. UL listed 3 core AWG18 cable is also available.

MADE IN ITALY

6,2 mm

2 x 0.75mm²

6,6 mm

3 x 0.75mm²



Round natural cables

The natural beauty of linen and jute makes our electrical cables unique. In various shades, they bring a touch of warmth and nature to any space, becoming a valuable decorative element.

Specifications:

H03VV-F 300/300VAC 2x0,75mm² or 3x0,75mm² Flex Round IMQ-HAR Cable DOUBLE INSULATION under textile braid. CE

The cable is sold by the meter, multiple orders will be delivered in one piece up to a maximum of 50 meters in length. UL listed 3 core AWG18 cable is also available.

MADE IN ITALY

6,2 mm

2 x 0.75mm²

6,6 mm

3 x 0.75mm²



Cotton and linen cables

Not only colours can be mixed, but fabrics too! In this small selections, linen, cotton, glitters are put together to create some totally new patterns.

Specifications:

H03VV-F 300/300VAC 2x0,75mm² or 3x0,75mm² Flex Round IMQ-HAR Cable DOUBLE INSULATION under textile braid. CE

The cable is sold by the meter, multiple orders will be delivered in one piece up to a maximum of 50 meters in length. UL listed 3 core AWG18 cable is also available.

MADE IN ITALY

6,2 mm



2 x 0.75mm²

6,6 mm



3 x 0.75mm²

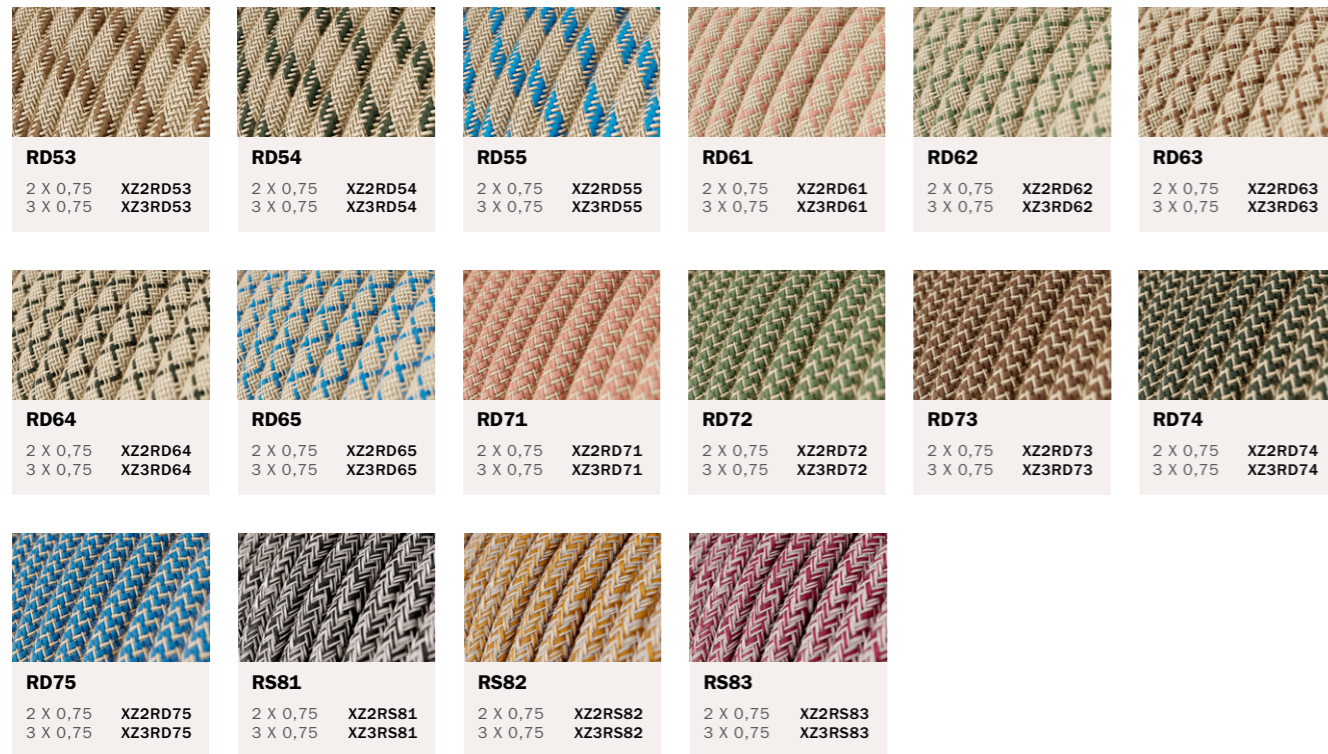

Copper-coated electrical cables

These cables stand out for their elegance and brightness, that pops right out of the copper covering. The finish is perfect for refined settings, classic or modern. They are available only with three internal conductors and grounding cable.

Specifications:

H03VV-F 300/300VAC 3x0,75mm² Flex Round IMQ-HAR Cable DOUBLE INSULATION under textile braid. CE
UK
CA

Diameter: 6,6mm
The cable is sold by the meter, multiple orders will be delivered in one piece up to a maximum of 50 meters in length.

MADE IN ITALY

6,9 mm



3 x 0.75mm²

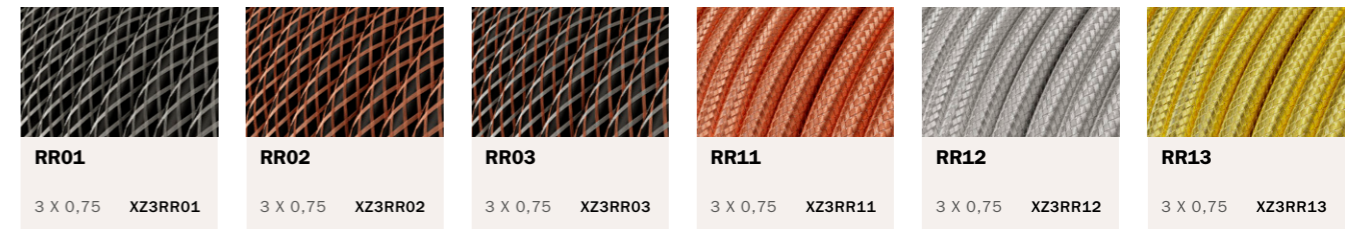

Round glitter cables

Available in multiple colors, electric cables with a glittery effect bring a touch of sparkling cheer to any setting. With their shimmering mood, they are perfect for creating a glamorous and sophisticated ambiance.

Specifications:

H03VV-F 300/300VAC 2x0,75mm² or 3x0,75mm² Flex Round IMQ-HAR Cable DOUBLE INSULATION under textile braid. CE
UK
CA

The cable is sold by the meter, multiple orders will be delivered in one piece up to a maximum of 50 meters in length. UL listed 3 core AWG18 cable is also available.

MADE IN ITALY

6,2 mm



2 x 0.75mm²

6,6 mm



3 x 0.75mm²

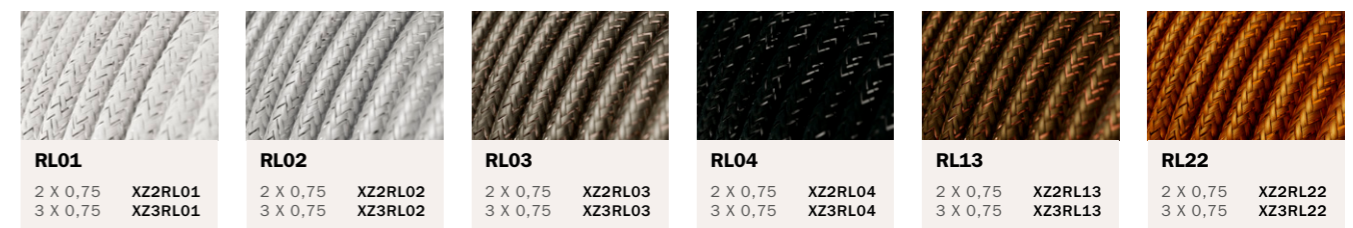

Twisted glossy-effect cables

Ideal for lighting projects with a modern and elegant look, our glossy-effect cables offer a bright and shiny finish. Their bright, solid finish is elegant yet informal.

Specifications:

300/300VAC 2x0,75mm² or 3x0,75mm²
 Flex Twisted Visible Spiral Cable DOUBLE INSULATION (additional transparent sheath), braided woven cloth textile sleeve.

The cable is sold by the meter, multiple orders will be delivered in one piece up to a maximum of 50 meters in length.

CE
UK
CA

MADE IN ITALY

6,2 mm 6,6 mm

2 x 0,75mm² 3 x 0,75mm²

 TM01 2 X 0,75 XZ2TM01 3 X 0,75 XZ3TM01	 TM00 2 X 0,75 XZ2TM00 3 X 0,75 XZ3TM00	 TM02 2 X 0,75 XZ2TM02 3 X 0,75 XZ3TM02	 TM26 2 X 0,75 XZ2TM26 3 X 0,75 XZ3TM26	 TM04 2 X 0,75 XZ2TM04 3 X 0,75 XZ3TM04	 TM13 2 X 0,75 XZ2TM13 3 X 0,75 XZ3TM13
 TM19 2 X 0,75 XZ2TM19 3 X 0,75 XZ3TM19	 TM09 2 X 0,75 XZ2TM09 3 X 0,75 XZ3TM09	 TM15 2 X 0,75 XZ2TM15 3 X 0,75 XZ3TM15	 TM22 2 X 0,75 XZ2TM22 3 X 0,75 XZ3TM22	 TM05 2 X 0,75 XZ2TM05 3 X 0,75 XZ3TM05	 TM25 2 X 0,75 XZ2TM25 3 X 0,75 XZ3TM25
 TM10 2 X 0,75 XZ2TM10 3 X 0,75 XZ3TM10	 TM21 2 X 0,75 XZ2TM21 3 X 0,75 XZ3TM21	 TM20 2 X 0,75 XZ2TM20 3 X 0,75 XZ3TM20	 TM12 2 X 0,75 XZ2TM12 3 X 0,75 XZ3TM12	 TM08 2 X 0,75 XZ2TM08 3 X 0,75 XZ3TM08	 TZ22 2 X 0,75 XZ2TZ22 3 X 0,75 XZ3TZ22

Twisted cotton cables

Thanks to their special twisted texture, they look like braids. Cotton has a natural look and matches cozy and minimal environments. Ideal for those seeking a natural mood.

Specifications:

300/300VAC 2x0,75mm² or 3x0,75mm²
 Flex Twisted Visible Spiral Cable DOUBLE INSULATION (additional transparent sheath), braided woven cloth textile sleeve.







The cable is sold by the meter, multiple orders will be delivered in one piece up to a maximum of 50 meters in length.

CE
UK
CA

MADE IN ITALY

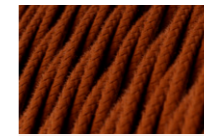
6,2 mm 6,6 mm

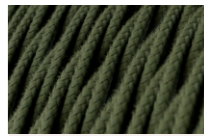
2 x 0,75mm² 3 x 0,75mm²

 TC01 2 X 0,75 XZ2TC01 3 X 0,75 XZ3TC01	 TC04 2 X 0,75 XZ2TC04 3 X 0,75 XZ3TC04	 TC23 2 X 0,75 XZ2TC23 3 X 0,75 XZ3TC23	 TC13 2 X 0,75 XZ2TC13 3 X 0,75 XZ3TC13	 TC43 2 X 0,75 XZ2TC43 3 X 0,75 XZ3TC43	 TC63 2 X 0,75 XZ2TC63 3 X 0,75 XZ3TC63
 TC53 2 X 0,75 XZ2TC53 3 X 0,75 XZ3TC53					



Twisted natural cables

Linen and jute bring warmth and coziness to any room, perfectly complementing furniture made from natural materials such as wood, and earthy color palettes. For a peaceful and inviting ambiance.

Specifications:

300/300VAC 2x0,75mm² or 3x0,75mm²
 Flex Twisted Visible Spiral Cable DOUBLE INSULATION (additional transparent sheath), braided woven cloth textile sleeve.

The cable is sold by the meter, multiple orders will be delivered in one piece up to a maximum of 50 meters in length.

CE
UK
MADE IN ITALY

6,2 mm 6,6 mm

2 x 0,75mm² 3 x 0,75mm²



Marlene hairy-effect cables

Marlene is the collection of twisted cables featuring a glamorous look that recalls the glamour of Hollywood divas of the 1950s. The hairy-effect finish evokes the charming outfits with fluttering feathers; a must for those who want to give elegance and charm to their spaces.

Specifications:

Fabric-covered hairy-effect lighting cable
 300/300V 2x0,75 or 3x0,75

Double insulation (additional transparent sheathing)
 20-20 CEI 20-35 RoHS compliant

CE
MADE IN ITALY

6,2 mm 6,6 mm

2 x 0,75mm² 3 x 0,75mm²

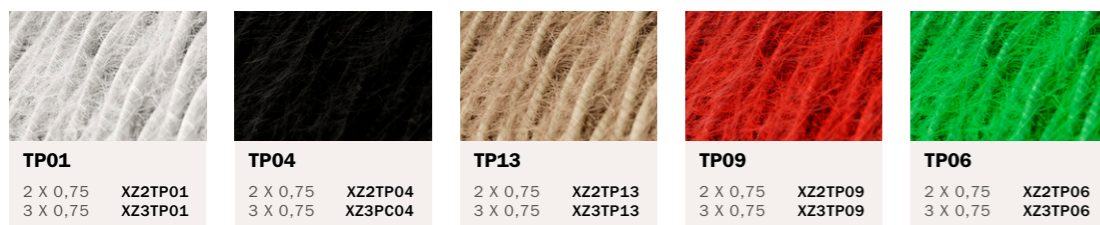

Vertigo cables

Thanks to the uniqueness of their patterns, these cables are a must for those who enjoy playing with colors and for those who want to add that extra touch to special setups. In different materials.

Specifications:

H03VV-F 300/300VAC 2x0,75mm² or 3x0,75mm²
 Flex Round IMQ-HAR Cable DOUBLE INSULATION under textile braid.

Technology and design of Vertigo cables registered by Elexa Cavi. The cable is sold by the meter, multiple orders will be delivered in one piece up to a maximum of 50 meters in length.

Vertigo cables are exclusively distributed worldwide by Creative Cables.

PATENTED

CE
MADE IN ITALY

6,2 mm 6,6 mm

2 x 0,75mm² 3 x 0,75mm²



LARGE SECTION CABLES

Our large section (3x1,50mm²) cables will help you when you require some extra power: multi sockets, power leads, wall installations, extension cables. Choose among the offered styles (round, twisted) for what best serves your purpose: they are incredibly flexible, because we use high quality PVC to avoid bulges or wrinkles. All of our large section cables are IMQ-HAR certified, the highest quality standard in Europe. Every single product is designed and Made in Italy.

Large round glossy-effect cables

Glossy-effect cables feature a sleek solid finish that is both elegant and casual. They can add color wherever it's desired.

Specifications:

H05VV-F 300/500VAC 3x1,50mm²
Flex Round IMQ-HAR Cable DOUBLE INSULATION under textile braid.

The cable is sold by the meter, multiple orders will be delivered in one piece up to a maximum of 50 meters in length.

MADE IN ITALY

8,5 mm

3 x 1,50mm²

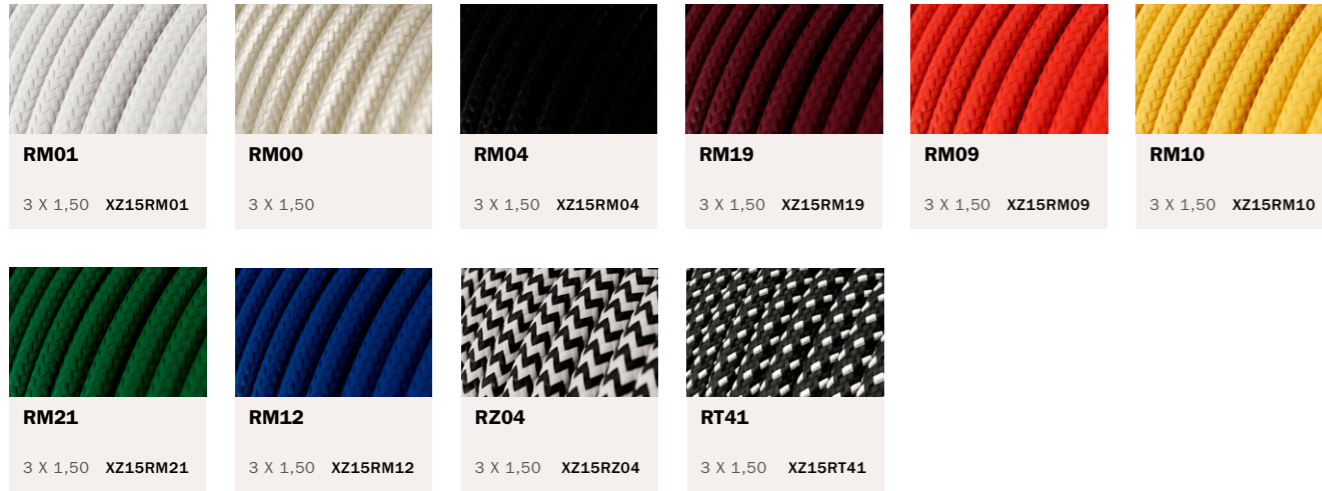

Large round natural fabric cables

These cables covered by Jute or linen are perfect to create extension cords, multi-sockets or to bring power to your electrical appliances, all while maintaining a natural style.

Specifications:

H05VV-F 300/500VAC 3x1,50mm²
Flex Round IMQ-HAR Cable DOUBLE INSULATION under textile braid.

The cable is sold by the meter, multiple orders will be delivered in one piece up to a maximum of 50 meters in length.

MADE IN ITALY

8,5 mm

3 x 1,50mm²

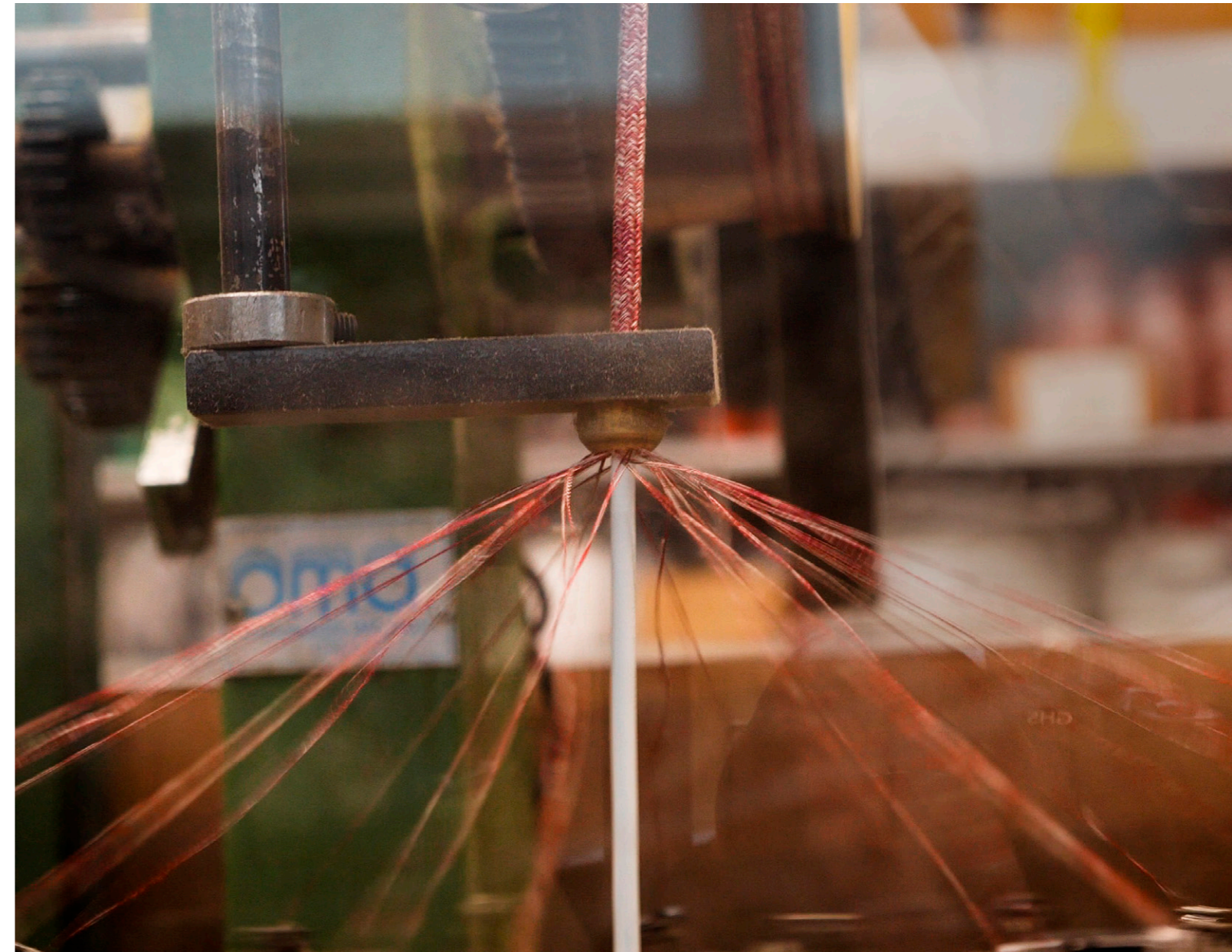
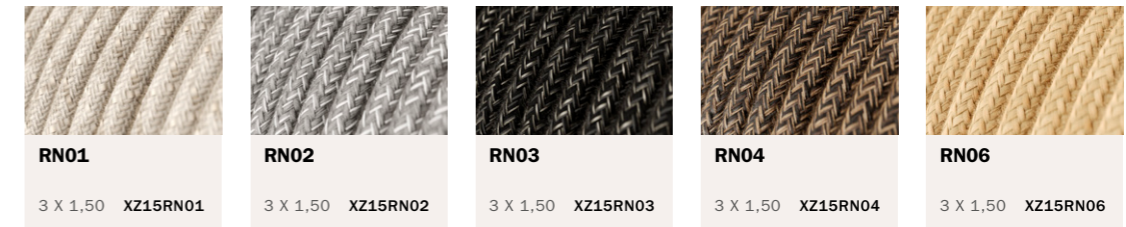



Large twisted natural cables

With their distinctive twisted texture and their covering in linen or jute, these electric cables create a natural and cozy ambiance in any space.

Specifications:

300/300Vac 3x1,5mm²
 Flex Twisted Visible Spiral Cable DOUBLE INSULATION
 (additional transparent sheath), braided woven cloth textile sleeve.

The cable is sold by the meter, multiple orders will be delivered in one piece up to a maximum of 50 meters in length.

CE
 UK
 CA
 MADE IN ITALY

9 mm
 3 x 1,50mm²

TN01	TN02	TN03	TN03	TN06
3 X 1,50 XZ15TN01	3 X 1,50 XZ15TN02	3 X 1,50 XZ15TN03	3 X 1,50 XZ15TN03	3 X 1,50 XZ15TN06

Large twisted glossy-effect cables

Featuring a unique twisted texture resembling braids, our glossy-effect cables offer a silky elegant finish.

Specifications:

300/300Vac 3x1,5mm²
 Flex Twisted Visible Spiral Cable DOUBLE INSULATION
 (additional transparent sheath), braided woven cloth textile sleeve.

The cable is sold by the meter, multiple orders will be delivered in one piece up to a maximum of 50 meters in length.

CE
 UK
 CA
 MADE IN ITALY

9 mm
 3 x 1,50mm²

TM01	TM00	TM02	TM04	TM13	TM09
3 X 1,50 XZ15TM01	3 X 1,50 XZ15TM00	3 X 1,50 XZ15TM02	3 X 1,50 XZ15TM04	3 X 1,50 XZ15TM13	3 X 1,50 XZ15TM09

TM05
3 X 1,50 XZ15TM05

ROPE CABLES

Covered with soft flock and raw jute in order to increase their diameters, cables can become a nautical rope with various thicknesses, colours and finishes. Inspired by the maritime style, they can create a totally unexpected suspension lamp. Every single product is designed and Made in Italy.

Rope cables

The electrical cable becomes an electrical cord.

The double covered electrical cables are covered with soft flocked and raw jute, resulting in a very large diameter.

Specifications:

300/300VAC 3x0,75mm²
Visible Spiral Flexible Cable which is double insulated, under the fabric braid.

The cable is sold by the meter, multiple orders will be delivered in one piece up to a maximum of 20 meters in length.

CE
UK
CA

MADE IN ITALY

XL

16 mm

3 x 0.75mm²

				
CLS16JUT	CLS16LIN	CLS16NERO	CLS16ORLEANS	CLS16VERDE
				
CLS16COUNTRY	CLS16COTLIN	CLS16COT	CLS16BERNADOTTE	CLS16BORDEAUX

XXL

24 mm

3 x 0.75mm²





				
CLS24JUT	CLS24LIN	CLS24NERO	CLS24ORLEANS	CLS24VERDE
				
CLS24COUNTRY	CLS24COTLIN	CLS24COT	CLS24BERNADOTTE	CLS24BORDEAUX

XXXL

30MM

30 mm

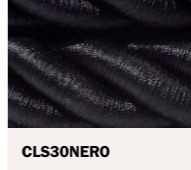
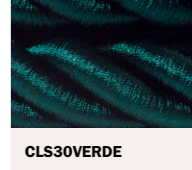
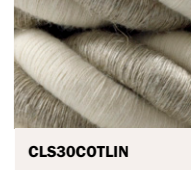
3 x 0.75mm²

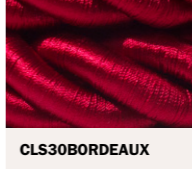
				
CLS30JUT	CLS30LIN	CLS30NERO	CLS30VERDE	CLS30COTLIN
				
CLS30COT	CLS30BORDEAUX			

Jute rope cables

This cable is featured by a double coating: the round electric cable covered in jute is enriched by the external coating of the braided jute cord thus reaching a 24mm diameter. In this way you can treat the cord like any other cable.

Specifications:

H03VV-F 300/300VAC 2x0,75mm²
Flex Round IMQ-HAR Cable DOUBLE INSULATION under textile braid.

Cover cable diameter: 24mm
The cable is sold by the meter, multiple orders will be delivered in one piece up to a maximum of 20 meters in length.

MADE IN ITALY

6,2 mm

24 mm

2 x 0.75mm²

		
XZ2RCLS24-20	Z2RCLS24-21	XZ2RCLS24-22



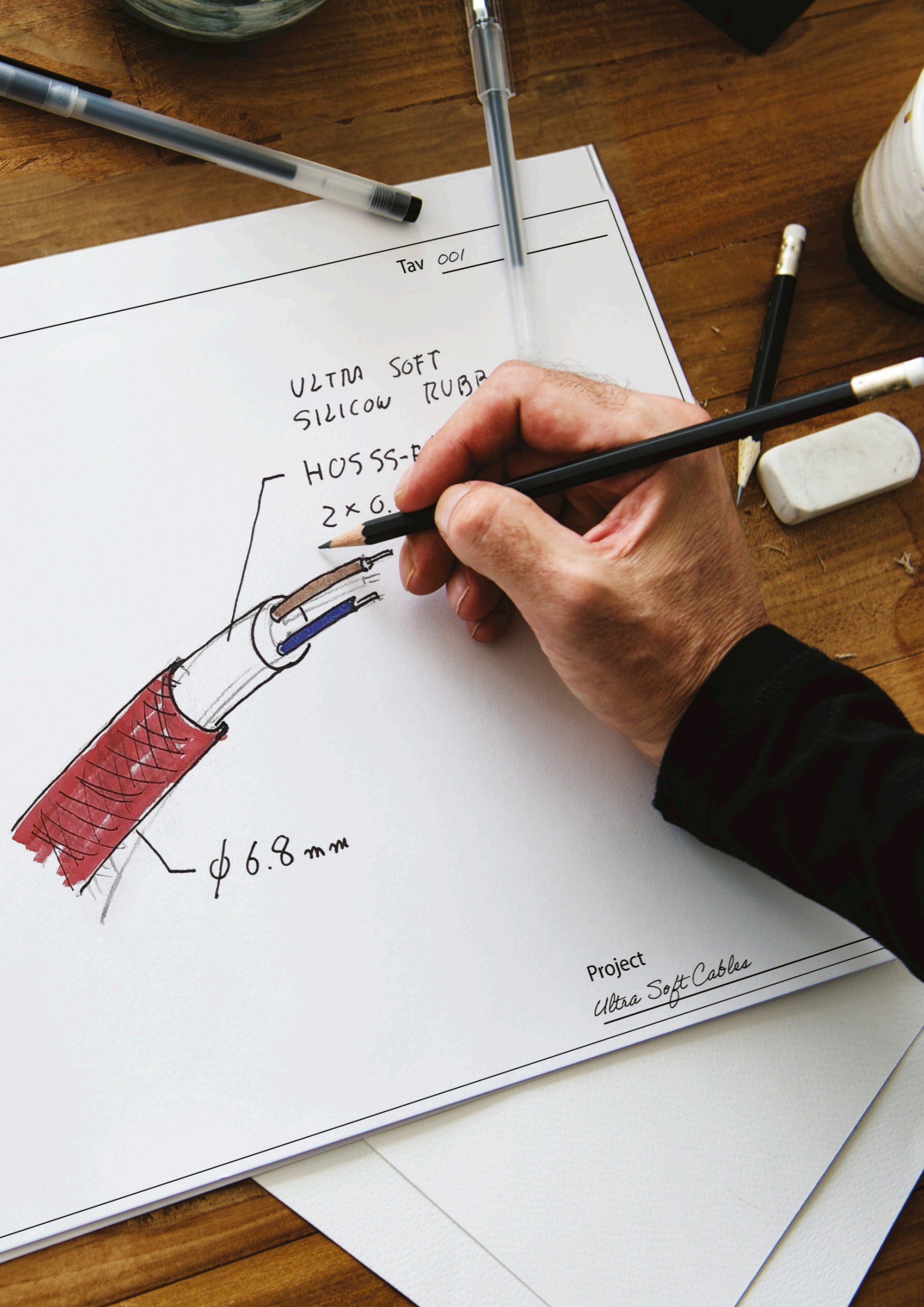

ULTRA SOFT SILICONE ELECTRIC CABLE

The electric cable with fabric lining has never been so flexible: these cables are even softer compared to traditional ones made from PVC, while still guaranteeing the same efficiency and safety. This premium product was designed to ensure flawless falls for any suspension lamp, preventing ugly creases or wrinkles.

Specifications:

H05SS-F 300/500V 2x0,75mm²
 Flex Round IMQ-HAR Cable DOUBLE INSULATION under textile braid.
 Standard reference: EN 50525-2-83 RoHS 2011/65/UE REACH 1907/2006

NEW

The cable is sold by the meter, multiple orders will be delivered in one piece up to a maximum of 50 meters in length.
 3 core AWG18 cable is also available

MADE IN ITALY

6,8 mm



2 x 0,75mm²

Round glossy-effect cables

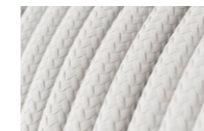

RM01
 2 X 0,75
 XZ2SILRM01



RM04
 2 X 0,75
 XZ2SILRM04

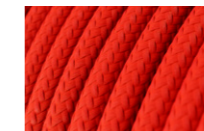

RM09
 2 X 0,75
 XZ2SILRM09

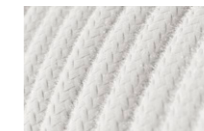

RC01
 2 X 0,75
 XZ2SILRC01



RC04
 2 X 0,75
 XZ2SILRC04

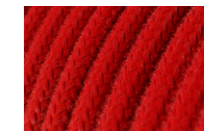

RC35
 2 X 0,75
 XZ2SILRC35

Round natural cables

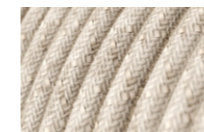

RN01
 2 X 0,75
 XZ2SILRN01

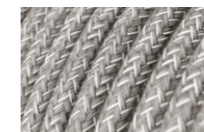

RN02
 2 X 0,75
 XZ2SILRN02

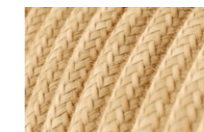

RN06
 2 X 0,75
 XZ2SILRN06



EXTRA LOW VOLTAGE CABLES

The two-pin Extra Low Voltage electrical cable in white extra-flexible silicone is covered in glossy effect fabric. The cable is ideal for movable luminaires (table / floor lamps) in class III and for fixed installations (wall, ceiling and pendant lamps) in class II with a rated current of not more than 2A.

The size and structure of the cable make it suitable for LED applications with a voltage of less than 48V.

The cable is 3.5 mm in diameter (approximately 4 mm covered) and has 2 copper conductors covered in black and red silicone rubber with a cross-section of 0.35 mm².

Caution: do not use for mains voltage and halogen bulbs.

Specifications:

Flexible bipolar cable insulated with white silicone
 2 copper conductors coated with black and red rubber section 0.35mm
 Rated voltage 300/500 V
 Test voltage 2kV
 IEC EN 60228 Class 5
 IEC EN 60754-1/2
 The size and structure of the cable make it suitable for LED applications with a voltage of less than 48V.

CE
 UK
 CA

MADE IN ITALY

3,8 mm

2 x 0.35mm²

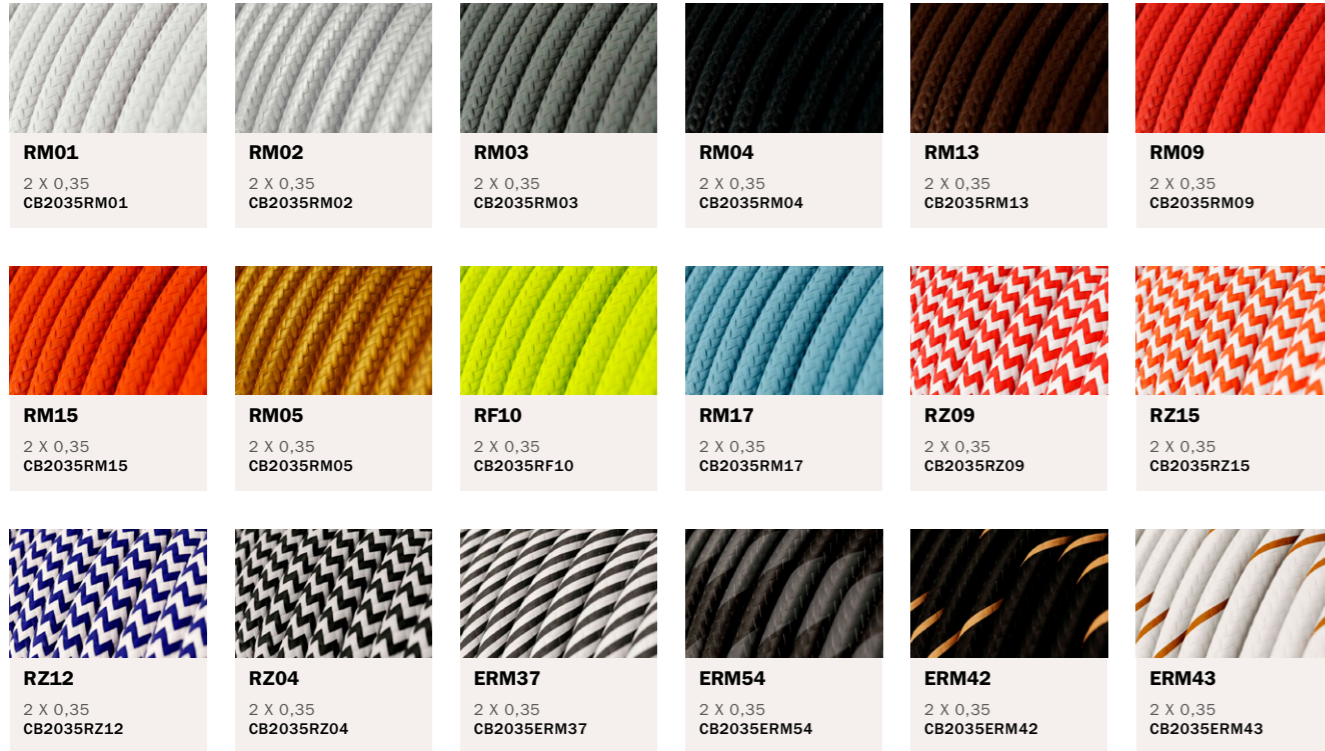

OUTDOOR EIVA CABLES

The EIVA outdoor cables are 100% Made in Italy and IMQ-HAR certified, guaranteeing safety, flexibility, and weather resistance. These cables are designed to be compatible with the EIVA IP65 Outdoor System, which is a waterproof and rain-resistant lighting system.

Specifications:

H05RN-F 300/500VAC 2x1mm²
 Rubber sheathed flexible round IMQ-HAR Cable DOUBLE INSULATION under textile braid.
 Standard reference: EN 50525-2-11, Low Voltage European Directive No. 2014/35/EU.

The cable is sold by the meter, multiple orders will be delivered in one piece up to a maximum of 50 meters in length.

MADE IN ITALY

7,6 mm

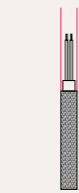

2 x 1.00mm²

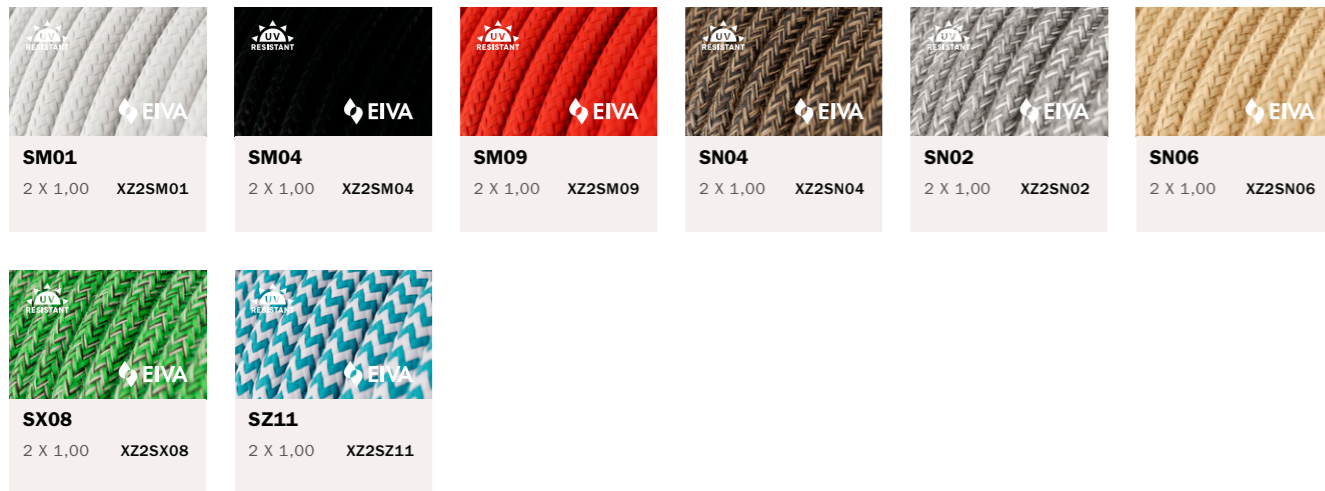

What does UV resistant cable mean?

It means the fabric used to line these cables was designed to resist UV rays, which make up around 10% of sunlight. The colour of UV resistant cables remains vibrant and doesn't tend to fade over time, even when they are consistently exposed to sunlight.





FLAT CABLES

Flat cables are Creative Cables solution allowing you to both create wonderful string-light for your garden parties and beautiful indoor designs through the Filé and Lumet Systems. Choose from a selection of colors and add the necessary accessories for your compositions.

Specifications:

H05RNH2-F 300/500 VAC Rectangular flat shaped 2x1,5mm² cable
 No flame propagation: in accordance with EN 60332-1-2/IEC 60332-1
 Referring Regulations: EN 50525-2-82 and IEC 60245

The cable is sold by the meter, multiple orders will be delivered in one piece up to a maximum of 25 meters in length.



MADE IN ITALY

13,5 mm

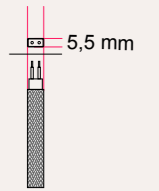

2 x 1.5mm²

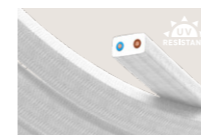

XZ15CM01

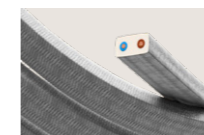

XZ15CM02

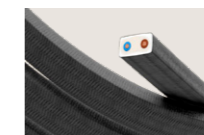

XZ15CM03

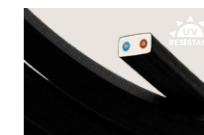

XZ15CM04

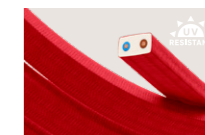

XZ15CM09

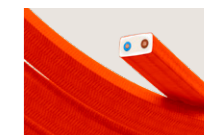

XZ15CF15

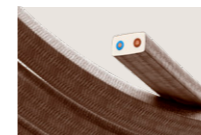

XZ15CM27

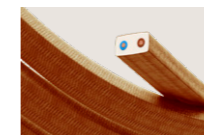

XZ15CM22

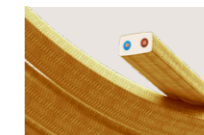

XZ15CM05

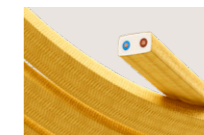

XZ15CM10

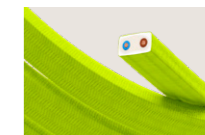

XZ15CF10

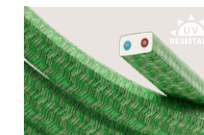

XZ15CX08

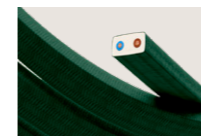

XZ15CM21

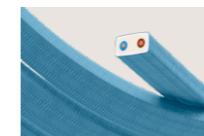

XZ15CM17

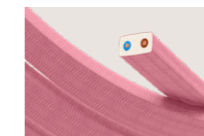

XZ15CM16

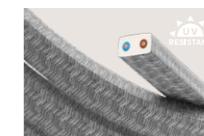

XZ15CN02

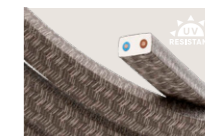

XZ15CN04

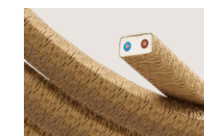

XZ15CN06

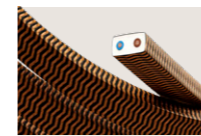

XZ15CZ22

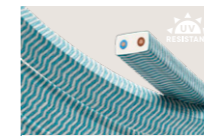

XZ15CZ11

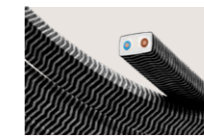

XZ15CZ04

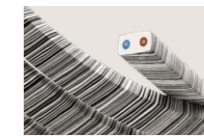

XZ15ECC37



What does UV resistant cable mean?

It means the fabric used to line these cables was designed to resist UV rays, which make up around 10% of sunlight. The colour of UV resistant cables remains vibrant and doesn't tend to fade over time, even when they are consistently exposed to sunlight.



LAMP HOLDERS

A lamp holder is an essential accessory for any design lamp.

We offer a wide range of shapes, sizes and materials that will easily match any living or working environment.

Lamp Holders can match or contrast the ceiling roses: it's up to you!

All our lamp holders are IMQ-ENEC certified, the highest quality standard in Europe.

METAL LAMP HOLDERS

Discover our wide selection of metal lamp holders. Choose from vintage or modern styles, classic or unique designs, and E14 or E27 fittings. Elevate your lighting with our stylish and durable lamp holders, allowing you to create the perfect ambiance for any space.

E27



Cylindrical lamp holder

Cover Material: **Metal**
 Rated Voltage/Current: **250V/4A**
 Cable Clamp: **Plastic Conical**
 Fitting: **E27**

UL Listed E26 socket is also available

Finish	Code	Finish	Code
Glossy White	KBM4011VB	Brass	KBM4011GO
Matt White	KBM4011VBO	Brushed Bronze	KBM4011OTS
Matt Black	KBM4011VN	Copper	KBM4011RA
Pearl Black	KBM4011BR	Brushed Copper	KBM4011RAS
Chrome	KBM4011CR	Dark Rust	KBM4011RU
Brushed Titanium	KBM4011TIS		



Cylindrical lamp holder

Cover Material: **Metal**
 Rated Voltage/Current: **250V/4A**
 Cable Clamp: **Metal Cylindrical**
 Fitting: **E27**

UL Listed E26 socket is also available

Finish	Code	Finish	Code
Glossy White	KBM4011VBTERP	Brass	KBM4011GOTERM
Matt White	KBM4011VBOTERM	Brushed Bronze	KBM4011OTSTERM
Matt Black	KBM4011VNTERM	Copper	KBM4011RATERM
Pearl Black	KBM4011BRTERM	Brushed Copper	KBM4011RASTERM
Chrome	KBM4011CRTERM	Dark Rust	KBM4011RUTERM
Brushed Titanium	KBM4011TISTERM		





Cylindrical lamp holder

Cover Material: **Metal**
 Rated Voltage/Current: **250V/4A**
 Cable Clamp: **Metal Cylindrical - 7 cm**
 Fitting: **E27**

UL Listed E26 socket is also available

Finish	Code	Finish	Code
Matt White	KBM4011VBOTERM4	Brass	KBM4011GOTERM4
Matt Black	KBM4011VNTERM4	Brushed Bronze	KBM4011OTSTERM4
Pearl Black	KBM4011BRTERM4	Copper	KBM4011BRTERM4
Chrome	KBM4011CRTERM4	Brushed Copper	KBM4011RASTERM4
Brushed Titanium	KBM4011TISTERM4	Dark Rust	KBM4011RUTERM4



Cylindrical lamp holder

Cover Material: **Metal**
 Rated Voltage/Current: **250V/4A**
 Cable Clamp: **Metal Cylindrical - 15 cm**
 Fitting: **E27**

UL Listed E26 socket is also available

Finish	Code	Finish	Code
Matt White	KBM4011VBOTERM5	Brass	KBM4011GOTERM5
Matt Black	KBM4011VNTERM5	Brushed Bronze	KBM4011OTSTERM5
Pearl Black	KBM4011BRTERM5	Copper	KBM4011RATERM5
Chrome	KBM4011CRTERM5	Brushed Copper	KBM4011RASTERM5
Brushed Titanium	KBM4011TISTERM5	Dark Rust	KBM4011RUTERM5



Half-sphere metal lamp holder

Cover Material: **Metal**
 Rated Voltage/Current: **250V/4A**
 Cable Clamp: **Plastic Conical**
 Fitting: **E27**

UL Listed E26 socket is also available

Finish	Code
White	25927
Black	25934
Chrome	25925
Red	25930



Pastel metal lamp holder

Cover Material: **Metal**
 Rated Voltage/Current: **250V/4A**
 Cable Clamp: **Hidden**
 Fitting: **E27**

Finish	Code
Petrol	KBM4367PE
Soft blue	KBM4367SB
Soft green	KBM4367VE
Mustard yellow	KBM4367MU



Vintage aluminum lamp holder

Cover Material: **Aluminium**
 Rated Voltage/Current: **250V/4A**
 Cable Clamp: **Plastic Conical**
 Fitting: **E27**

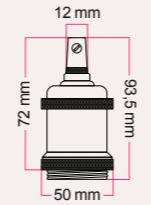

UL Listed E26 socket is also available

Finish Code

Brass	KBL27ALGO
Copper	KBL27ALRA
Chrome	KBL27ALCR
Pearl Black	KBL27ALBR



Double ring milled aluminium lamp holder

Cover Material: **Milled aluminium**
 Rated Voltage/Current: **250V/4A**
 Cable Clamp: **Metal Cylindrical**
 Fitting: **E27**

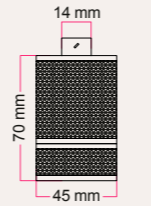

UL Listed E26 socket is also available

Finish Code

Gunmetal	KBR27ALCF
Brass	KBR27ALGO
Copper	KBR27ALRA



Lamp holder with double ferrule

Cover Material: **Metal**
 Rated Voltage/Current: **250V/4A**
 Cable Clamp: **Plastic Conical**
 Fitting: **E27**

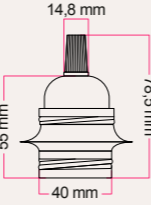

MADE IN ITALY

Finish Code

Gunmetal	PL27MZVCFU	Pearl Black	PL27MBRTF
Dark Rust	PL27MZVRUG	Brass	PL27MOTTF
Silver	PL27MARTF	Copper	PL27MRATF



Lamp holder with double ferrule

Cover Material: **Metal**
 Rated Voltage/Current: **250V/4A**
 Cable Clamp: **Metal Cylindrical**
 Fitting: **E27**

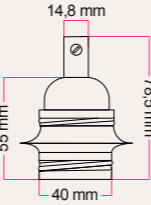

MADE IN ITALY

Finish Code

Gunmetal	PL27MZVCFUTERM	Pearl Black	PL27MBRTFTERM
Dark Rust	PL27MZVRUGTERM	Brass	PL27MOTFTERM
Silver	PL27MARTFTERM	Copper	PL27MRATFTERM



Semi-flush lamp holder

Cover Material: **Metal**
 Rated Voltage/Current: **250V/4A**
 Cable Clamp: **Hidden**
 Fitting: **E27**

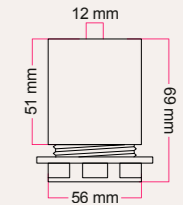

Finish Code

Matt White	KBM4551VBO	Mustard yellow	KBM4551MU
Matt Black	KBM4551VN	Dark Rust	KBM4551RU
Petrol	KBM4551PE	Brushed Bronze	KBM4551OTS
Soft blue	KBM4551SB	Brushed Copper	KBM4551RAS
Soft green	KBM4551VE	Brushed Titanium	KBM4551TIS

E14



Double ferrule lamp holder for lampshade

Cover Material: **Metal**
 Rated Voltage/Current: **250V/2A**
 Cable Clamp: **Plastic Conical**
 Fitting: **E14**

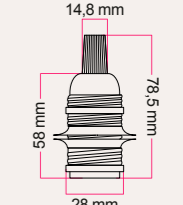

MADE IN ITALY

Finish Code

Silver	PL14MARTF
Brass	PL14MOTTF
Copper	PL14MRATF

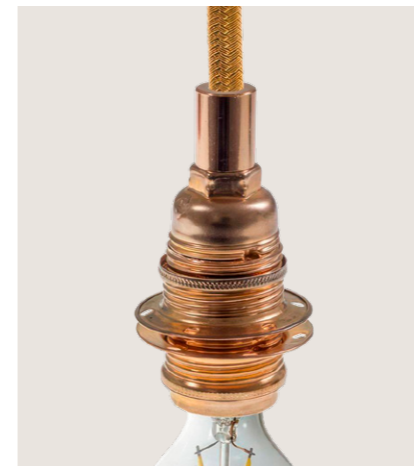

Double ferrule lamp holder for lampshade

Cover Material: **Metal**
 Rated Voltage/Current: **250V/2A**
 Cable Clamp: **Metal Cylindrical**
 Fitting: **E14**

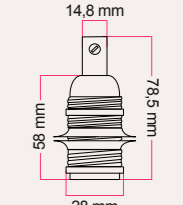

MADE IN ITALY

Finish Code

Silver	PL14MARTFTERM
Brass	PL14MOTFTERM
Copper	PL14MRATFTERM

P-LIGHT

P-light is the unique E14 fitting lamp holder kit allowing you to create special lighting solutions with tubular light bulbs. You'll be able to create single or multiple pendant suspensions, perfect to illuminate rooms or different dimensions. Combine up to 15 pendants by matching P-Light with our selection of decorated Rose-One-System XXL ceiling roses or pair it with smaller roses to create the pendant lamp best matches you interior. From monochromatic shades up to brushed metal finishes, this little yet functional lamp holder kit is available in a variety of versions. This makes it suitable for different kinds of styles and interior design needs.



P-light lamp holder

Cover Material: **Metal**

Rated Voltage/Current: **250V/2A**

Cable Clamp: **Hidden**

Fitting: **E14**



Finish	Code	Finish	Code
● Matt Black	KBME14VN	● Brushed Bronze	KBME14OTS
● Brushed Titanium	KBME14TIS	● Copper	KBME14RA
● Brass	KBME14GO	● Brushed Copper	KBME14RAS

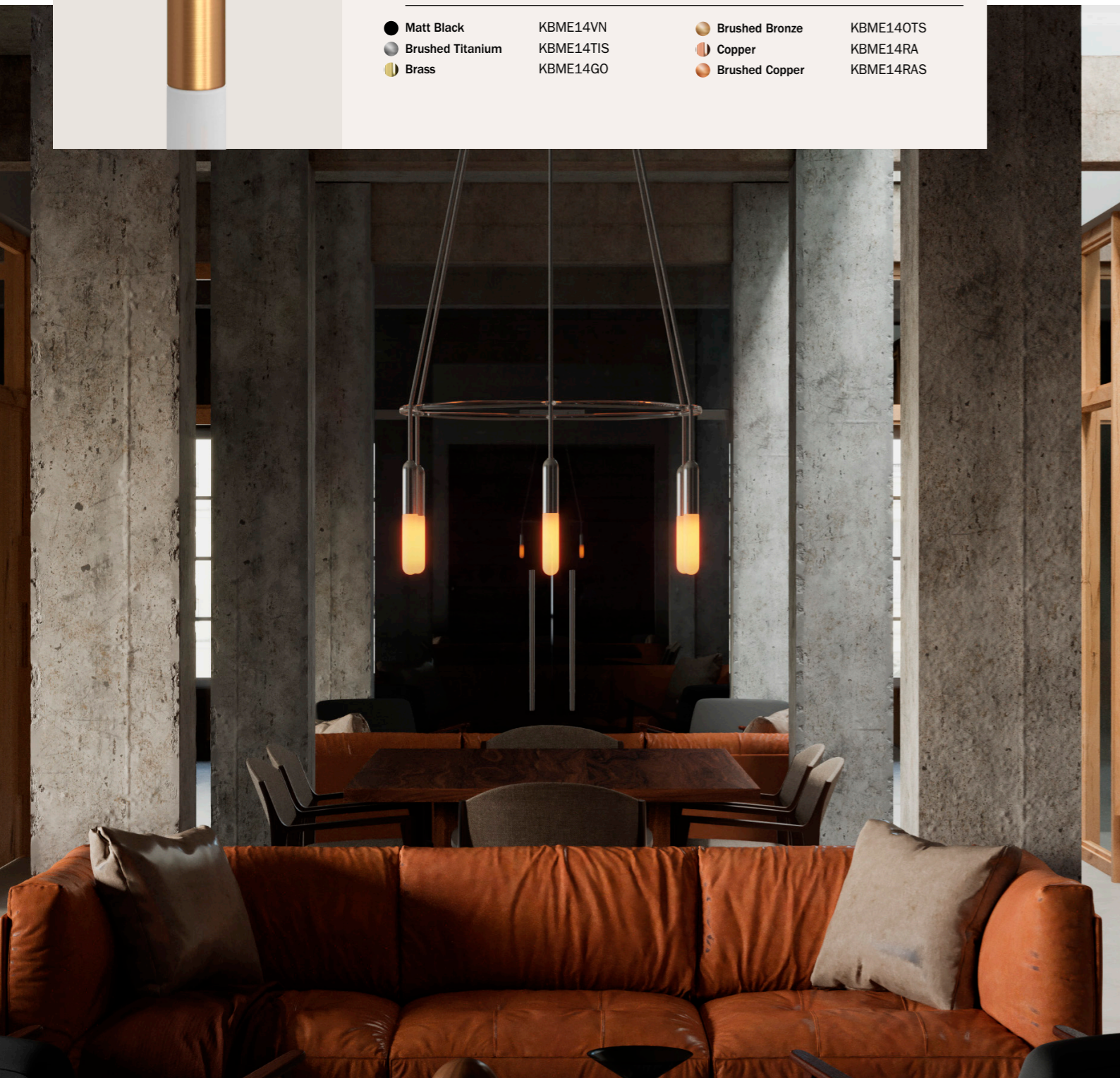

WOODEN E27 LAMP HOLDER

Explore our catalog for a wide selection of wooden lamp holders. Choose from vintage or modern styles with exposed or concealed cable grips, suitable for both naked bulbs and lampshades. Wooden lamp holders bring natural elegance, warmth, and versatility to your lighting, making them an eco-friendly and stylish choice for any space.



Wooden lamp holder

Cover Material: **Wood**

Rated Voltage/Current: **250V/4A**

Cable Clamp: **Plastic Conical**

Fitting: **E27**

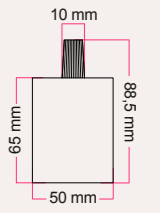

Finish	Code
● Matt White	KBL0210
● Matt Black	KBL0310
● Neutral	KBL0110



Wooden lamp holder for XL cord

Cover Material: **Wood**

Rated Voltage/Current: **250V/4A**

Cable Clamp: **Hidden**

Fitting: **E27**

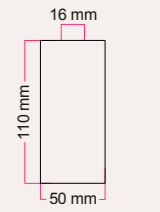

Finish	Code
● Matt White	KBL0216
● Matt Black	KBL0316
● Neutral	KBL0116



Wooden lamp holder for 2XL cord

Cover Material: **Wood**

Rated Voltage/Current: **250V/4A**

Cable Clamp: **Hidden**

Fitting: **E27**

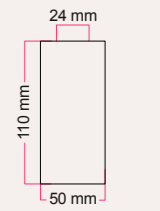

Finish	Code
● White	KBL0224
● Black	KBL0324
● Wenge effect	KBL0424
● Neutral	KBL0124



Large bark lamp holder

Cover Material: **Wood** CE
 Rated Voltage/Current: **250V/4A**
 Cable Clamp: **Hidden**
 Fitting: **E27**

MADE IN ITALY



UL Listed E26 socket is also available

Finish	Code
● Bark	KBL0422016

● Bark KBL0422016



Small bark lamp holder

Cover Material: **Wood** CE
 Rated Voltage/Current: **250V/4A**
 Cable Clamp: **Hidden**
 Fitting: **E27**

MADE IN ITALY



UL Listed E26 socket is also available

Finish	Code
● Bark	KBL0411016

● Bark KBL0411016

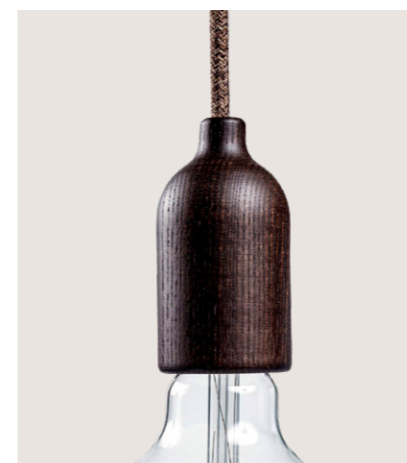

Wooden lamp holder

Cover Material: **Wood** CE
 Rated Voltage/Current: **250V/4A**
 Cable Clamp: **Hidden**
 Fitting: **E27**

MADE IN ITALY

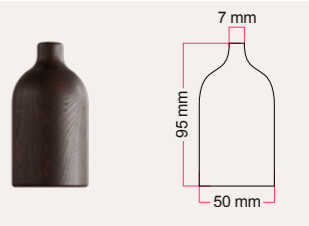

Finish	Code
● Neutral	KBL1110
● Wenge Effect	KBL1410

● Neutral KBL1110
● Wenge Effect KBL1410

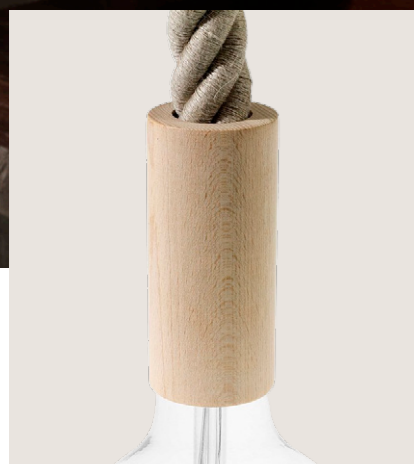

Wooden lamp holder for 3XL cord

Cover Material: **Wood** CE
 Rated Voltage/Current: **250V/4A**
 Cable Clamp: **Hidden**
 Fitting: **E27**

MADE IN ITALY

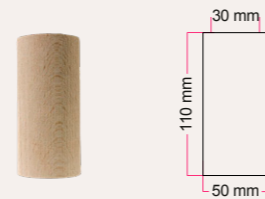



Finish	Code
● Matt White	KBL0230
● Matt Black	KBL0330
● Neutral	KBL0130

● Matt White KBL0230
● Matt Black KBL0330
● Neutral KBL0130

NEW

Hemispherical lamp holder for lampshade

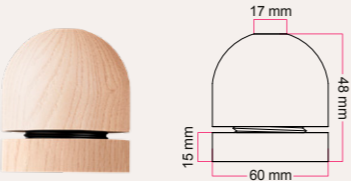

Cover Material: **Wood**  
 Rated Voltage/Current: **250V/4A**
 Cable Clamp: **Hidden**
 Fitting: **E27** MADE IN ITALY





Finish	Code
● Neutral	KBL2117

NEW

Cylindrical lamp holder for lampshade

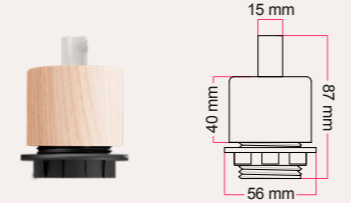
Cover Material: **Wood**  
 Rated Voltage/Current: **250V/4A**
 Cable Clamp: **Plastic Cylindrical**
 Fitting: **E27** MADE IN ITALY

Finish	Code
● Neutral	KBL3110



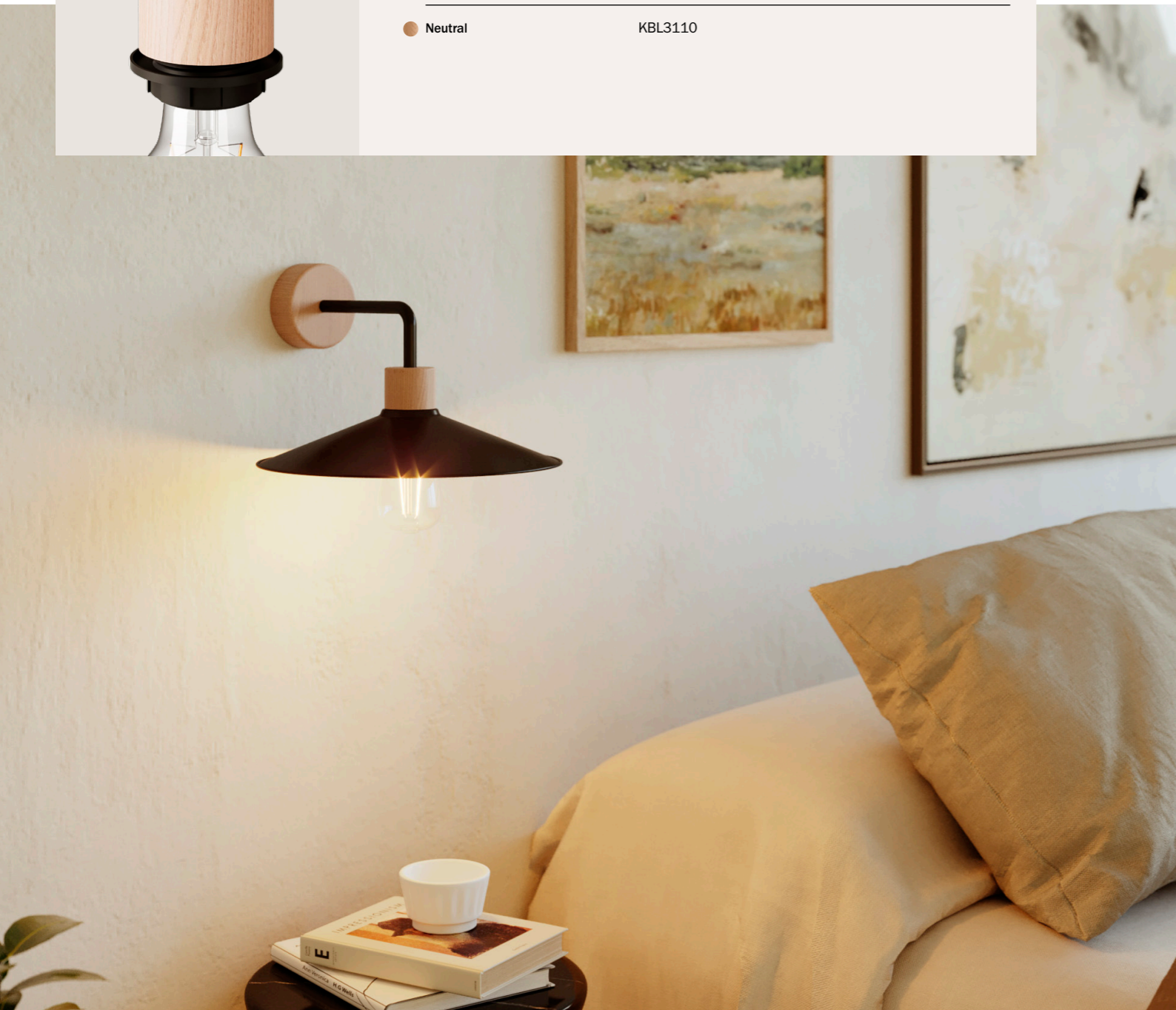

Filé E27 wooden lamp holder

A natural wood lamp holder designed for all string light cables. Match it with other products from the Filé system to create unique wall or ceiling decorations.



Filé system string light lamp holder

Material: **Wood** 
 Rated Voltage/Current: **250V/4A**
 Compatible cables: **String lights 2x/3x**
 Fitting: **E27** MADE IN ITALY

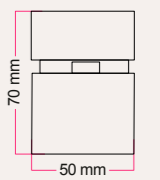
Finish	Code
● White	BLCAT02
● Black	BLCAT03
● Neutral	BLCAT01

SILICONE E27

Silicone lamp holders are resistant, colorful and easy to install. Last but not least, they have a very attractive price! Each lamp holder has a matching silicone ceiling rose.



NEW

Silicon lamp holder

Cover Material: **Silicone**

Rated Voltage/Current: **250V/4A**

Cable Clamp: **Hidden**

Fitting: **E27**

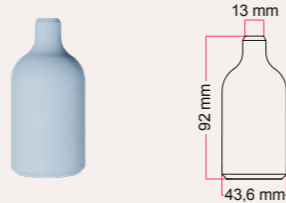

13 mm
92 mm
43,6 mm

Finish	Code	UL Listed E26 socket is also available	
White	KBS27BIA	Soft Green	KBS27VE
Black	KBS27NER	Petrol	KBS27PE
Grey	KBS27GRI	Soft Blue	KBS27SB
Desert Brown	KBS27DB	Salmon	KBS27SAL
Yellow Mustard	KBS27MU	Red	KBS27RSS
Yellow	KBS27GIA	Orange	KBS27ARA

SILICONE E27 WITH SWITCH

A fun and colorful E27 silicone lamp holder with a switch, perfect for pairing with exposed light bulbs. Crafted from high-quality materials, this product is not only durable but also soft and lightweight, while maintaining flexibility.



NEW

Silicon lamp holder with switch

Cover Material: **Silicone**

Rated Voltage/Current: **250V/4A**

Cable Clamp: **Hidden**

Fitting: **E27**

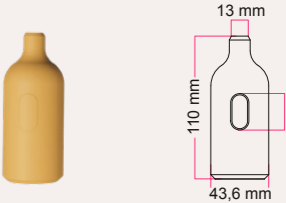

13 mm
110 mm
28 mm
43,6 mm

Finish	Code	UL Listed E26 socket is also available	
White	KBS27SWBIA	Soft Green	KBS27SWVE
Black	KBS27SWNER	Petrol	KBS27SWPE
Grey	KBS27SWGRI	Soft Blue	KBS27SWSB
Desert Brown	KBS27SWDB	Salmon	KBS27SWSAL
Yellow Mustard	KBS27SWMU	Red	KBS27SWRSS
Yellow	KBS27SWVE	Orange	KBS27SWARA

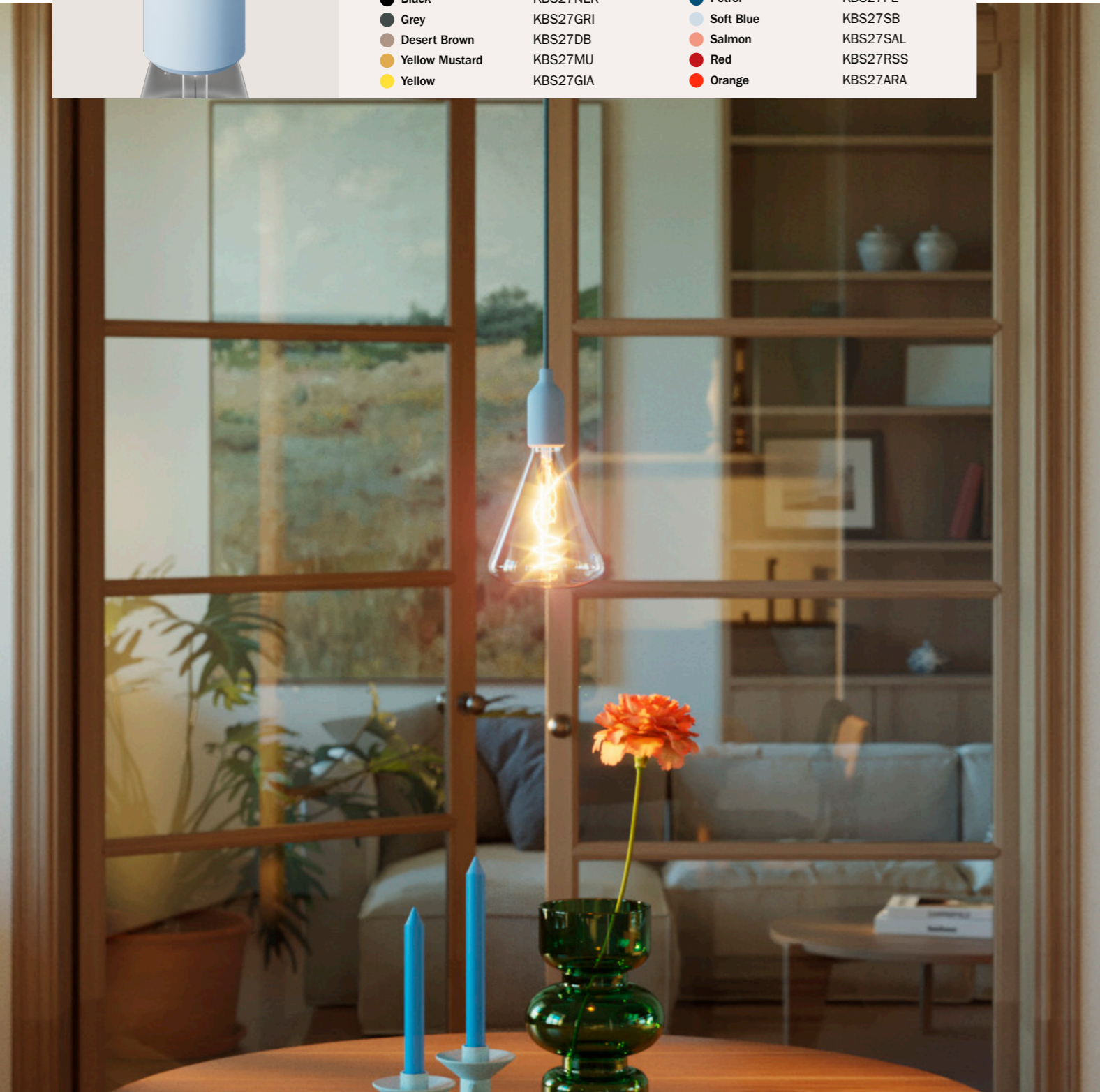

RECYCLED PLASTIC E27 LAMP HOLDER

A colorful and fun E27 lamp holder with a distinctive shape and a strong personality, perfectly embodying the Creative Cables style. It is exclusively made from recycled plastic using 3D printing technology.



NEW

3D printed lamp holder

Cover Material: **Recycled plastic**

Rated Voltage/Current: **250V/4A**

Cable Clamp: **Hidden**

Fitting: **E27**

MADE IN ITALY



71 mm
41 mm

Finish	Code	UL Listed E26 socket is also available	
● Eggshell	KB3D27CREMA	● Cobalt	KB3D27BLU
● Ochre	KB3D27OCRA	● Terracotta	KB3D27TERRA
● Sage green	KB3D27CVERDE	● Ancient pink	KB3D27ROSA



THERMOPLASTIC E27 WALL OR CEILING LAMP HOLDER

The lamp holder with E27 socket is the simple and functional solution to create a wall or ceiling light point that can offer complementary light and give a refined decorative note to any wall. Choose the finish that best matches your interiors. Thanks to E27 socket, you can decide which bulb to match from our wide range of E27 decorative LED bulbs.



45° wall or ceiling lamp holder

Cover Material: **Thermoplastic**

Rated Power: **Max 75W**

Fitting: **E27**

MADE IN ITALY

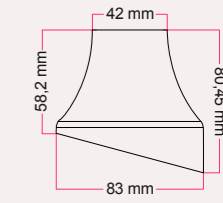

42 mm
58.2 mm
83 mm
59.08 mm

Finish	Code
● White	PL27PBIE
● Black	PL27PNIE



Metallic wall or ceiling lamp holder

Cover Material: **Metallized plastic**

Rated Power: **Max 75W**

Fitting: **E27**

MADE IN ITALY

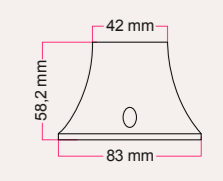

42 mm
58.2 mm
83 mm

Finish	Code
● White	PL27PBDE
● Black	PL27PNDE
● Chrome	KPL27PCRDE
● Copper	KPL27PRADE
● Gold	KPL27PGODE



EIVA LAMP HOLDER

Patented solution

Configure your EIVA system by selecting the components that best meet your needs. The IP65 single-entry lamp holders can be purchased naked or with a soft-touch silicone cover, making them ideal for single pendants or wall lamps. EIVA2 lamp holders allow you to create solutions with multiple light sources.



NEW

EIVA wirable lamp holder

Cover Material: **Thermoplastic** CE
 Rated Voltage/Current: **250V/4A** UK
 Cable Clamp: **Integrated** CA
 Fitting: **E27**

Finish	Code
● White	PL27PBEIVA
● Black	PL27PNEIVA

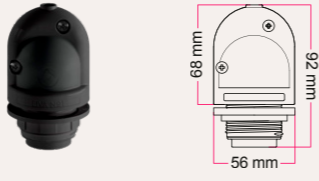

IP65 WATERPROOF





NEW

EIVA-2 lamp holder

Cover Material: **Thermoplastic** CE
 Rated Voltage/Current: **250V/4A** UK
 Cable Clamp: **Integrated** CA
 Fitting: **E27**

Finish	Code
● White	PL27PBEIVA2
● Black	PL27PNEIVA2

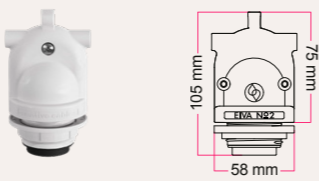

IP65 WATERPROOF







EIVA Pastel lamp holder

Cover Material: **Soft touch silicone** CE
 Rated Voltage/Current: **250V/4A** UK
 Cable Clamp: **Integrated** CA
 Fitting: **E27**

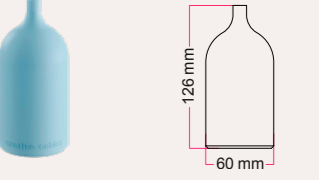
Finish	Code
● Black	KEIVAPABK
● Soft blue	KEIVAPASB
● Soft green	KEIVAPAVE
● Mustard yellow	KEIVAPAMU
● Salmon	KEIVAPASAL



IP65 WATERPROOF



EIVA Elegant lamp holder

Cover Material: **Soft touch silicone** CE
 Rated Voltage/Current: **250V/4A** UK
 Cable Clamp: **Integrated** CA
 Fitting: **E27**

Finish	Code
● White	KEIVAELO1BI
● Black	KEIVAELO1BK
● Glacier Grey	KEIVAELO1GG
● Petrol	KEIVAELO1PE



IP65 WATERPROOF



EIVA Elegant lamp holder for lampshades

Cover Material: **Soft touch silicone** CE
 Rated Voltage/Current: **250V/4A** UK
 Cable Clamp: **Integrated** CA
 Fitting: **E27**

Finish	Code
● White	KEIVAELO2BI
● Black	KEIVAELO2BK

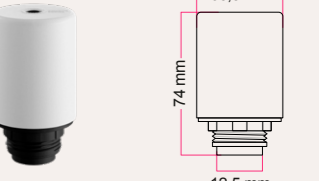

IP65 WATERPROOF

THERMOPLASTIC IP44 E27 LAMP HOLDER

The patented Creative Cables E27 lamp holder simplifies home lighting. With its sleek design, compact size, and versatile shape, you can create impressive lighting arrangements without the need for a ceiling rose. This E27 lamp holder is easy to mount on walls or ceilings. It's also IP44 rated, suitable for outdoor use under a canopy, on a patio, or in a bathroom near a mirror. Available in two versions: for naked light bulbs and lamp holders.



Waterproof membrane



NEW

Wall or ceiling lamp holder for lampshade

Cover Material: **Thermoplastic** CE

Rated Voltage/Current: **220-240V** UK

Cables: **0,75-1,5mm²** CA

Fitting: **E27** MADE IN ITALY



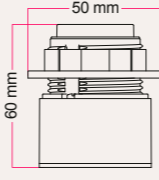

Finish	Code
● White	IP44-E27-2-B
● Black	IP44-E27-2-N

SPØSTALUCE

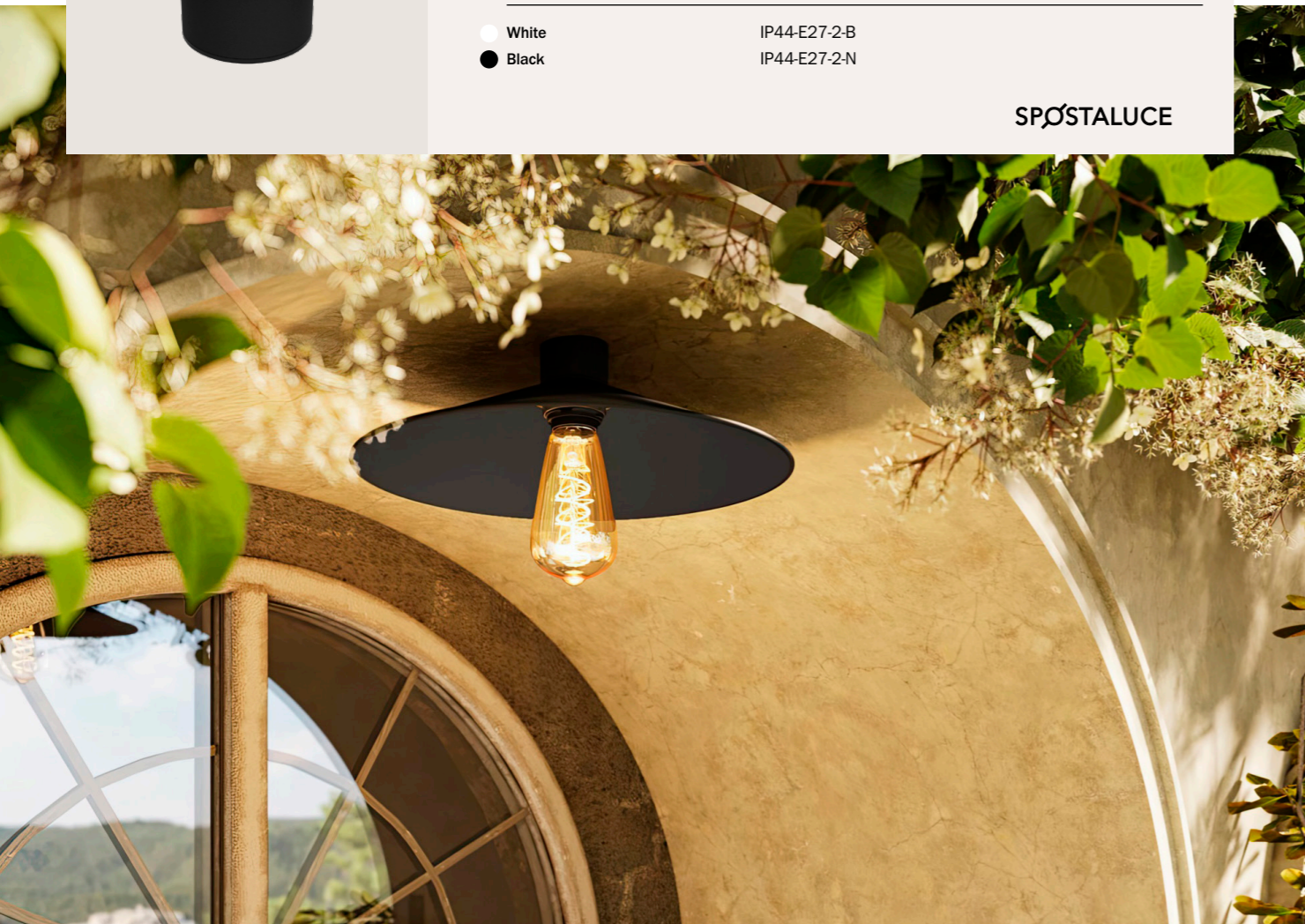



NEW

Wall or ceiling lamp holder

Cover Material: **Thermoplastic** CE

Rated Voltage/Current: **220-240V**

Cables: **0,75-1,5mm²**

Fitting: **E27** MADE IN ITALY



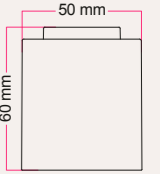

Finish	Code
● White	IP44-E27-1-B
● Black	IP44-E27-1-N

SPØSTALUCE

THERMOPLASTIC S14 LAMP HOLDER

With patented esse14 lamp holder using LED S14D lightbulbs will be easier than ever, and even more striking. Thanks to its curved lines, small size and designer touch, you will be able to shape your creations without overloading the lamp or taking up too much space. Attach it directly to the wall, no rose needed.



Waterproof membrane

NEW

Esse14 IP44 wall or ceiling lamp holder

Cover Material: **Thermoplastic**
 Rated Voltage/Current: **220/240 V**
 Fitting: **S14d**

CE
UK
CA

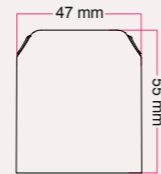

MADE IN ITALY

Finish

Code

White	PLS14DPB	White marble effect	PLS14DPWM
Black	PLS14DPN	Brown marble effect	PLS14DPBM
Wenge effect	PLS14DPDW	Green marble effect	PLS14DPGM
Neutral	PLS14DPLW		

IP44



NEW

Esse 14 lamp holder for suspension lamps

Cover Material: **Thermoplastic**
 Rated Voltage/Current: **220/240V**
 Cable Clamp: **Metal Cylindrical**
 Fitting: **S14d**

CE
UK
CA

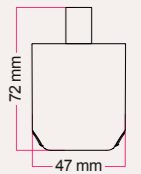

MADE IN ITALY

Finish

Code

White	PLS14DSPB	White marble effect	PLS14DSPWM
Black	PLS14DSPN	Brown marble effect	PLS14DSPBM
Wenge effect	PLS14DSPDW	Green marble effect	PLS14DSPGM
Neutral	PLS14DSPLW		



NEW

Esse 14 lamp holder for suspension lamps

Cover Material: **Thermoplastic**
 Rated Voltage/Current: **220/240V**
 Cable Clamp: **Metal Cylindrical**
 Fitting: **S14d**

CE
UK
CA



MADE IN ITALY

Finish

Code

White	PLS14DSPB	White marble effect	PLS14DSPWM
Black	PLS14DSPN	Brown marble effect	PLS14DSPBM
Wenge effect	PLS14DSPDW	Green marble effect	PLS14DSPGM
Neutral	PLS14DSPLW		

FILÉ LAMP HOLDERS

Provide your pendant lighting the exact illumination you desire by choosing from a variety of lamps and lamp holders to connect to it. Opt for classic wooden lamp holders, either natural or painted, suitable for exposed bulbs or lampshades.



Lumet string lights lamp holder

Cover Material: **Thermoplastic** CE
 Rated Voltage/Current: **250V/4A**
 Fitting: **E27**

Finish	Code
● Black	PLC27TPN19

● **IP44 WATER RESISTANT**



63 mm
47 mm

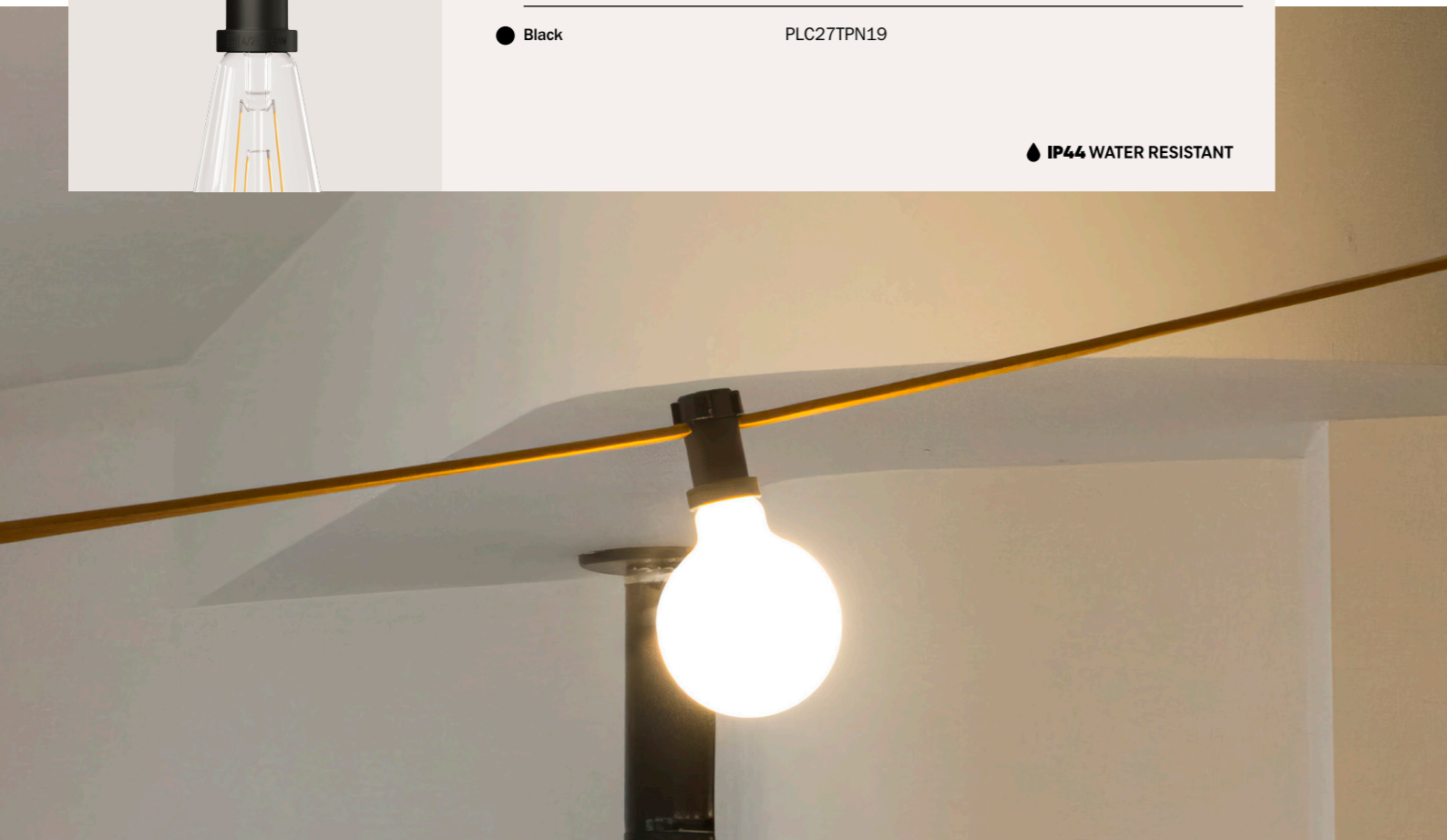

Filé system lamp holder for lampshade

Material: **Thermoplastic** CE
 Rated Voltage/Current: **250V/4A**
 Suitable lampshades: **40mm to 50mm**
 Fitting: **E27**

Finish	Code
● Black	PLC27PNTF



56 mm
56 mm

THERMOPLASTIC LAMP HOLDERS

Discover our extensive selection of thermoplastic lamp holders, available in vintage or modern styles, with or without switches, suitable for both exposed bulbs and lampshades. These lamp holders combine durability and security, giving you the choice between classic or contemporary designs while offering flexibility in lighting style.

E27



Thermoplastic lamp holder

Cover Material: **Thermoplastic** CE UK CA
 Rated Voltage/Current: **250V/4A**
 Cable Clamp: **Not Included**
 Fitting: **E27**

Finish	Code
● White	PL27PBLI
● Black	PL27PNLI

UL Listed E26 socket is also available

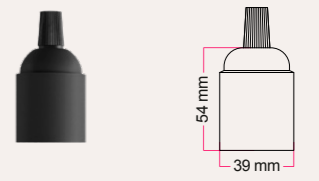

54 mm
39 mm



Thermoplastic lamp holder with switch

Cover Material: **Thermoplastic** CE UK CA
 Rated Voltage/Current: **250V/4A**
 Cable Clamp: **Not Included**
 Fitting: **E27**

Finish	Code
● White	PL27PBLINB
● Black	PL27PNLINB

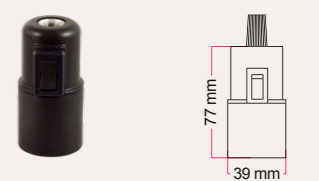

77 mm
39 mm



Thermoplastic lamp holder with pull switch

Cover Material: **Thermoplastic** CE UK CA
 Rated Voltage/Current: **250V/4A**
 Cable Clamp: **Not Included**
 Fitting: **E27**

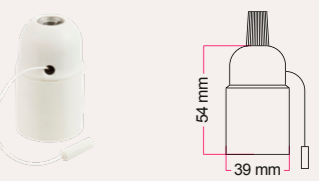

Finish	Code
● White	PL27PBLINT
● Black	PL27PNLINT



54 mm
39 mm





Double ferrule lamp holder for lampshade

Cover Material: **Thermoplastic**  
 Rated Voltage/Current: **250V/4A**
 Cable Clamp: **Not Included**
 Fitting: **E27**

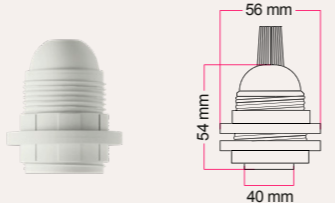

Finish **Code**

● White PL27PBTF
 ● Black PL27PNTF

UL Listed E26 socket is also available





Double ferrule lamp holder with pull switch

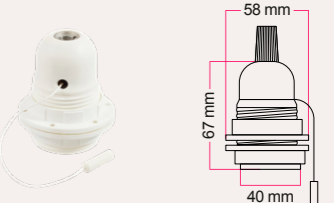

Cover Material: **Thermoplastic**  
 Rated Voltage/Current: **250V/4A**
 Cable Clamp: **Not Included**
 Fitting: **E27**

Finish **Code**

● White PL27PBTFNT
 ● Black PL27PNTFNT





Double ferrule lamp holder with switch

Cover Material: **Thermoplastic**  
 Rated Voltage/Current: **250V/4A**
 Cable Clamp: **Not Included**
 Fitting: **E27**

Finish **Code**

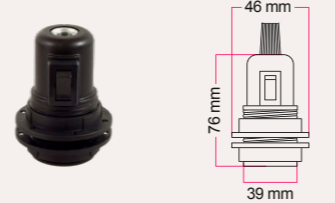

● White PL27PBTFNB
 ● Black PL27PNTFNB



E14





Thermoplastic lamp holder

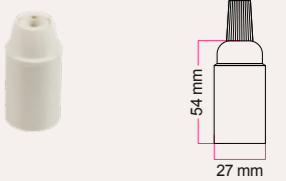

Cover Material: **Thermoplastic**  
 Rated Voltage/Current: **250V/2A**
 Cable Clamp: **Not Included**
 Fitting: **E14**

Finish **Code**

● White PL14PBLI
 ● Black PL14PNLI





Double ferrule lamp holder for lampshade

Cover Material: **Thermoplastic**  
 Rated Voltage/Current: **250V/2A**
 Cable Clamp: **Not Included**
 Fitting: **E14**

Finish **Code**

● White PL14PBTF
 ● Black PL14PNTF



BAKELITE LAMP HOLDERS

A bakelite lamp holder is perfect for assembling a classic wall, table, or ceiling lamp. Bakelite, named after its inventor, is a thermosetting resin that evokes memories of telephones, radios, and other objects from the 1950s and 1960s. It is a lightweight and durable material, and when painted, it acquires a glossy finish.

E27



Bakelite lamp holder

Material: **Bakelite** 
 Rated Voltage/Current: **250V/4A**
 Cable Clamp: **Not Included**
 Fitting: **E27**







Finish **Code** UL Listed E26 socket is also available

- White PL27BBLI
- Black PL27BNLI
- Gold PL27BOLI

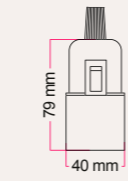

Bakelite lamp holder with switch

Material: **Bakelite** 
 Rated Voltage/Current: **250V/4A**
 Cable Clamp: **Not Included**
 Fitting: **E27**





Finish **Code** UL Listed E26 socket is also available

- White PL27BBLIN
- Black PL27BNLIN



Double ferrule lamp holder for lampshade

Material: **Bakelite** 
 Rated Voltage/Current: **250V/4A**
 Cable Clamp: **Not Included**
 Fitting: **E27**

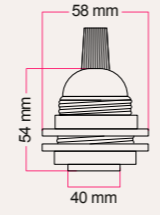



Finish **Code** UL Listed E26 socket is also available

- White PL27BBTF
- Black PL27BNTF
- Gold PL27BOTF



Double ferrule lamp holder with switch

Material: **Bakelite** 
 Rated Voltage/Current: **250V/4A**
 Cable Clamp: **Not Included**
 Fitting: **E27**

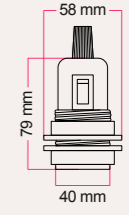
Finish **Code** UL Listed E26 socket is also available

- White PL27BBFIN
- Black PL27BNFIN

E14



Bakelite lamp holder

Material: **Bakelite** 
 Rated Voltage/Current: **250V/2A**
 Cable Clamp: **Not Included**
 Fitting: **E14**







Finish **Code** UL Listed E26 socket is also available

- White PL14BBLI
- Black PL14BNLI
- Gold PL14BOLI

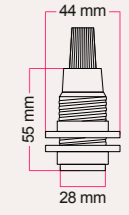

Double ferrule lamp holder for lampshade

Material: **Bakelite** 
 Rated Voltage/Current: **250V/2A**
 Cable Clamp: **Not Included**
 Fitting: **E14**





Finish **Code** UL Listed E26 socket is also available

- White PL14BBTF
- Black PL14BNTF
- Gold PL14BOTF

CERAMIC E27 LAMP HOLDER

Choose a ceramic lamp holder for a timeless and elegant solution that will make your wall or ceiling lamps truly unique.



Ceramic lamp holder

Cover Material: **Ceramic**
 Rated Voltage/Current: **250V/4A**
 Cable Clamp: **Plastic Conical**
 Fitting: **E27**

MADE IN ITALY

15 mm
66 mm
54 mm

Finish	Code	Finish	Code
White	83-CC001	Blue	83-CC008
Black	83-CC013	Purple	83-CC004
Grey	83-CC005	Burgundy	83-CC009
Cookie	83-CC000	Red	83-CC007
Ivory	83-CC002	Orange	83-CC006
Yellow	83-CC012	Tangerine	83-CC010
Pistachio Green	83-CC011		

UL Listed E26 socket is also available

CEMENT E27 LAMP HOLDER

Cement is a building material that has recently established itself as a real furnishing element inside houses and commercial activities. The porous surface typical of the material and the manufacturing process to which these components are subjected, results in a slightly different surface of each item from all the others, making each piece unique.

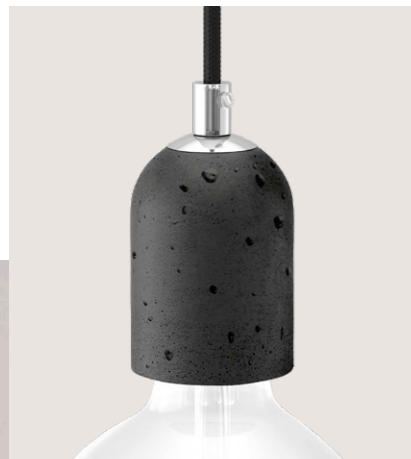

Cement lamp holder

Cover Material: **Cement**
 Rated Voltage/Current: **250V/4A**
 Cable Clamp: **Metal Cylindrical**
 Fitting: **E27**

MADE IN ITALY

10 mm
90 mm
60 mm

Finish	Code	Finish	Code
Light Cement	KBC2701CGL		
Dark Cement	KBC2701CGD		

UL Listed E26 socket is also available

PORCELAIN LAMP HOLDER

Porcelain is a timeless classic and an elegant solution that will make your wall or ceiling lamps absolutely unique. Each lamp holder has a matching porcelain ceiling rose.

E14



Porcelain lamp holder

Material: **Porcelain**
 Rated Voltage/Current: **250V/2A**
 Cable Clamp: **Plastic Conical**
 Fitting: **E14**

MADE IN ITALY

14,8 mm
60 mm
40 mm

Finish	Code	Finish	Code
White	KPLPE14BIA	Yellow	KPLPE14GIA
Black	KPLPE14NER	Red	KPLPE14ROS
Grey	KPLPE14GRI	Green	KPLPE14VER
Light Blue	KPLPE14AZZ		

E27



Porcelain lamp holder

Material: **Porcelain**
 Rated Voltage/Current: **250V/4A**
 Cable Clamp: **Plastic Conical**
 Fitting: **E27**

MADE IN ITALY

14,8 mm
60 mm
45 mm

Finish	Code	Finish	Code
White	25995	Sage green	KPLPVERDE
Black	KPLPNER	Green	KPLPVER
Grey	KPLPGRI	Ancient pink	KPLPROSA
Light Blue	KPLPAZZ	Red	KPLPROS
Yellow	KPLPGIA		

E40



Porcelain lamp holder

Material: **Porcelain**
 Rated Voltage/Current: **250V/4A**
 Cable Clamp: **Plastic Conical**
 Fitting: **E40**

MADE IN ITALY

14,8 mm
80 mm
65 mm

Finish	Code
White	KPLPE40BIA
Black	KPLPE40NER



SPOTLIGHTS

Spotlight lamps are the perfect focal point to illuminate your spaces with elegance and precision. Designed to provide direct and focused light, these lamps add style and functionality to any environment.

Thanks to their flexibility and adjustability, spotlights allow you to easily control the direction of the light beam, creating cozy atmospheres or targeted light points.

Choose from different designs and materials to customize your space with quality lighting and distinctive style.

TUB-E14

The Tub-E14 is the ideal lamp shade for anyone who enjoys using a spotlight. It provides a directed beam of light that creates an ambiance and is designed to fit an E14 double ring lamp holder. Tub-E14 is a multi-purpose lighting solution that works well as a shade for a single or multiple pendant lamps or wall lights.



Tub-E14 spotlight pipe double ferrule

Cover Material: **Metal** 
 Rated Voltage/Current: **250V/2A**
 Cable Clamp: **Conical**
 Fitting: **E14**

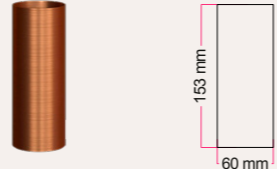

Finish **Code** UL Listed E26 socket is also available

● Matt White	KSPOTME14VBO	● Brushed Bronze	KSPOTME14OTS
● Black	KSPOTME14VN	● Brushed Copper	KSPOTME14RAS
● Brushed Titanium	KSPOTME14TIS		



Tub-E14 spotlight double ferrule

Cover Material: **Wood** 
 Rated Voltage/Current: **250V/2A**
 Cable Clamp: **Conical**
 Fitting: **E14** MADE IN ITALY

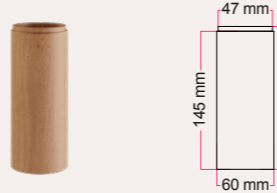

Finish **Code**

● Neutral	KSPOTLE1401
-----------	-------------

TUB-E14 DOUBLE-UP

Beauty doubles with the Tub-E14 double version.

The Tube-E14 shade has a minimalist design with a Scandinavian flair and is available in both metal and wood options with pleasing contrast.



Tub-E14 spotlight double ferrule lamp holder

Cover Material: **Metal / Wood** 
 Rated Voltage/Current: **250V/2A**
 Cable Clamp: **Conical**
 Fitting: **E14** MADE IN ITALY

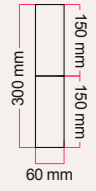

Finish **Code**

● Neutral - Matt White	K2SPOTLME14VB001	● Neutral - Br. bronze	K2SPOTLME140TS01
● Neutral - Black	K2SPOTLME14VN01	● Neutral - Br. copper	K2SPOTLME14RAS01
● Neutral - Br. titanium	K2SPOTLME14TIS01		



Tub-E14 spotlight double ferrule lamp holder

Cover Material: **Double Metal** 
 Rated Voltage/Current: **250V/2A**
 Cable Clamp: **Conical**
 Fitting: **E14** UL Listed E26 socket is also available

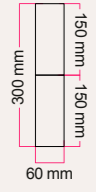

Finish **Code**

● White - Br. titanium	K2SPOTME14VBOTIS	● Black - Br. titanium	K2SPOTME14VNTIS
● White - Br. bronze	K2SPOTME14VB00TS	● Black - Br. bronze	K2SPOTME14VNOTS
● White - Br. copper	K2SPOTME14VBORAS	● Black - Br. copper	K2SPOTME14VNRAS

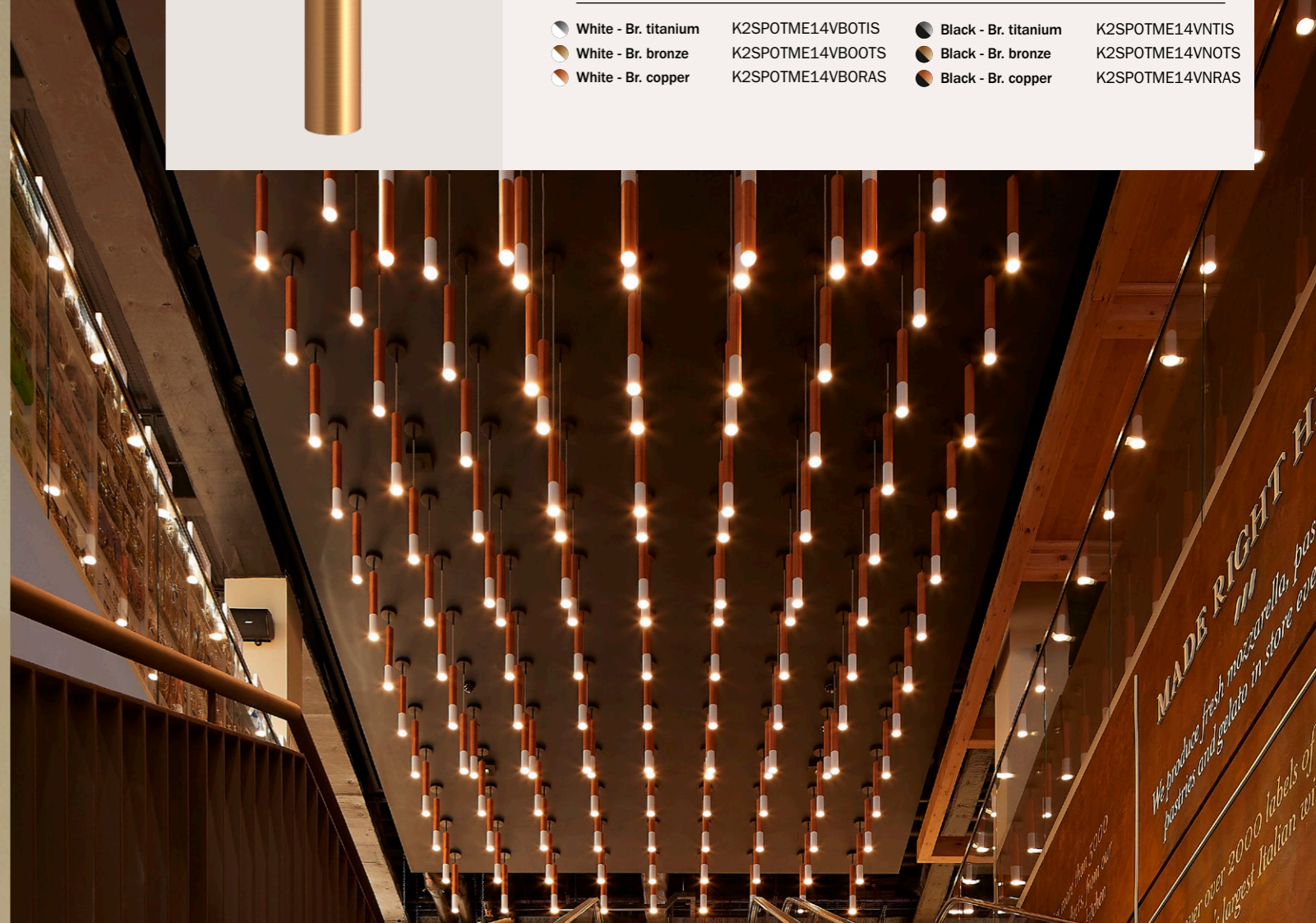

GU1D0

GU1d0 is a mini spotlight for directional LED lighting that allows you to illuminate your bedside table when reading, your child's homework, or any other spot where you need a direct and focused beam of light, producing approximately 260 lumens in a directional beam of about 36 degrees.



Mini Spotlight LED GU1d0

Cover Material: **Metal** CE
 Rated Voltage/Current: **250V/2A** UK
 Fitting: **Mini GU10 (MR11)**



Finish	Code		
● Matt White	KBMGU10VBO	● Mustard yellow	KBMGU10MU
● Black	KBMGU10VN	● Brushed Bronze	KBMGU10OTS
● Petrol	KBMGU10PE	● Brushed Copper	KBMGU10RAS
● Soft blue	KBMGU10SB	● Brushed Titanium	KBMGU10TIS
● Soft green	KBMGU10VE		



MINI GU10 INCLUDED

GU1d0 lamp holder is fitted with a MINI GU10 (or MR11) bulb, smaller than the normal GU10 bulb because of its 35 mm diameter and 46 mm height (socket included) that you can replace very easily by removing the silicone ring and rotating the bulb.



MINI GU10 LED LIGHT BULB

Fitting: **Mini GU10 (MR11)**
 Rated Voltage/Current: **110-240V**

CAGU10R11

3,2W
 2700K
 260Lm





CEILING ROSES

A ceiling rose serves as an elegant and functional element that not only complements your lighting fixture but also conceals wiring and adds a touch of sophistication to your ceiling.

Our collection includes a wide range of shapes, sizes, and materials, ensuring a seamless match with your home's unique style.

Follow this logo inside the catalog and discover all the components you can match

SPØSTALUCE

METAL CEILING ROSES

Among our best selling products, metal ceiling roses are available in 6 finishes. We also created the 2-3-4-5-6-7 hole versions to create multiple pendants: the side-holes roses can help design a totally customized wall or ceiling light fitting array. Cable clamps can be made from plastic or metal and have different lengths, for an even more personalised solutions.



METAL CEILING ROSE

Finish: **GLOSSY WHITE**

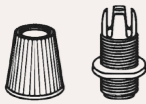

Plastic Cable Clamps

Code: **PC1SER01**



Metal Cable Clamps

Code: **SERM1VB**

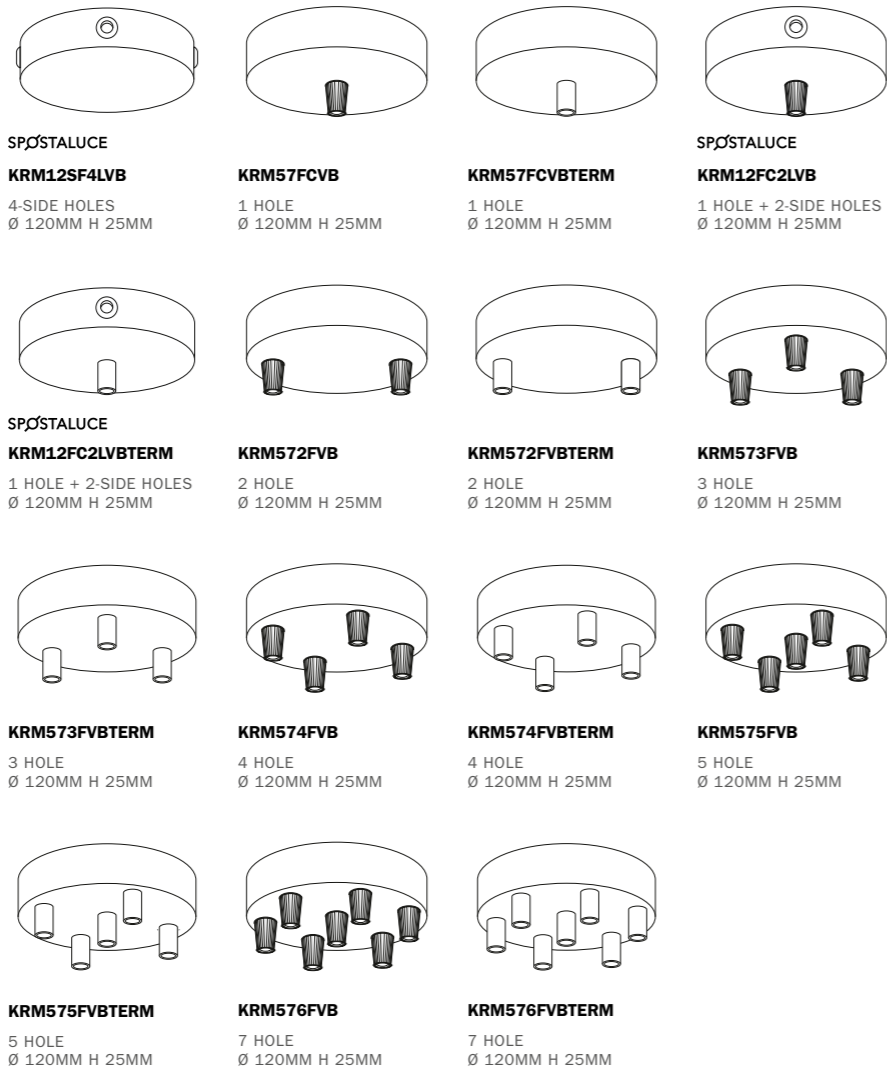



METAL CEILING ROSE

Finish: **MATT WHITE**

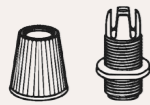

Plastic Cable Clamps

Code: **PC1SER01**



Metal Cable Clamps

Code: **SERM1VB**

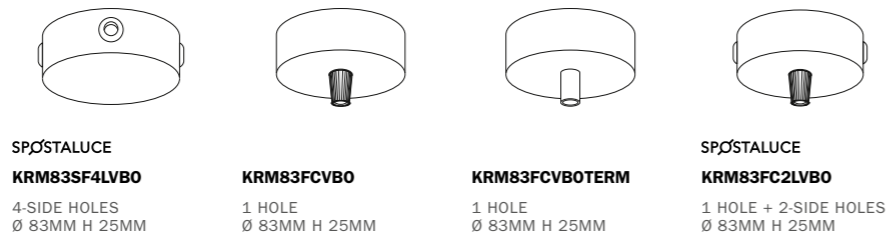

SPØSTALUCE
KRM83SF4LVBO
4-SIDE HOLES
Ø 83MM H 25MM

KRM83FCVBO
1 HOLE
Ø 83MM H 25MM

KRM83FCVBOTERM
1 HOLE
Ø 83MM H 25MM

SPØSTALUCE
KRM83FC2LVBO
1 HOLE + 2-SIDE HOLES
Ø 83MM H 25MM

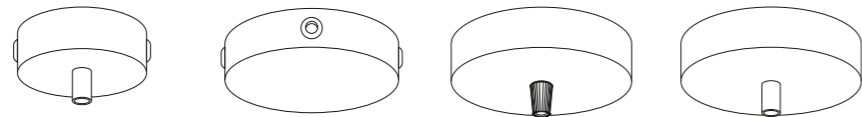

SPØSTALUCE
KRM83FC2LVBOTERM
1 HOLE + 2-SIDE HOLES
Ø 83MM H 25MM

SPØSTALUCE
KRM12SF4LVBO
4-SIDE HOLES
Ø 120MM H 25MM

KRM57FCVBO
1 HOLE
Ø 120MM H 25MM

KRM57FCVBOTERM
1 HOLE
Ø 120MM H 25MM

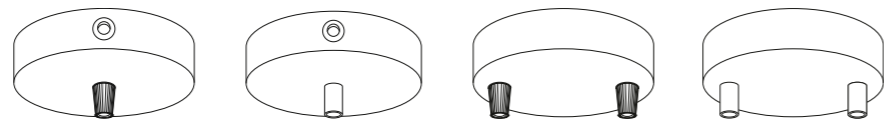

SPØSTALUCE
KRM12FC2LVBO
1 HOLE + 2-SIDE HOLES
Ø 120MM H 25MM

SPØSTALUCE
KRM12FC2LVBOTERM
1 HOLE + 2-SIDE HOLES
Ø 120MM H 25MM

KRM572FVBO
2 HOLE
Ø 120MM H 25MM

KRM572FVBOTERM
2 HOLE
Ø 120MM H 25MM

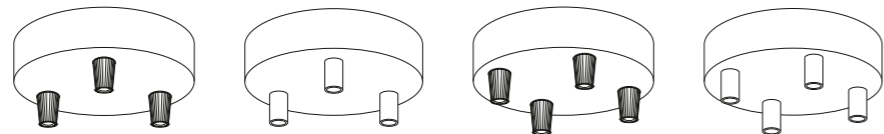

KRM573FVBO
3 HOLE
Ø 120MM H 25MM

KRM573FVBOTERM
3 HOLE
Ø 120MM H 25MM

KRM574FVBO
4 HOLE
Ø 120MM H 25MM

KRM574FVBOTERM
4 HOLE
Ø 120MM H 25MM

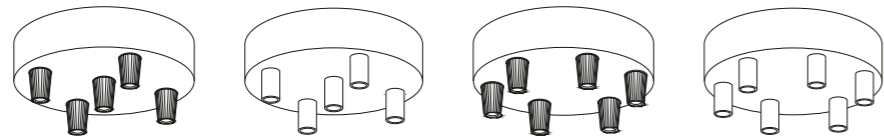

KRM575FVBO
5 HOLE
Ø 120MM H 25MM

KRM575FVBOTERM
5 HOLE
Ø 120MM H 25MM

KRM126FVBO
6 HOLE
Ø 120MM H 25MM

KRM126FVBOTERM
6 HOLE
Ø 120MM H 25MM

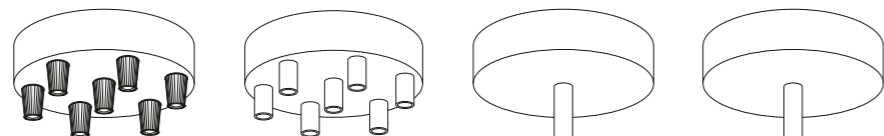

KRM576FVBO
7 HOLE
Ø 120MM H 25MM

KRM576FVBOTERM
7 HOLE
Ø 120MM H 25MM

KRM57FCVBOTERM4
1 HOLE + 70MM CLAMP
Ø 120MM H 25MM

KRM57FCVBOTERM5
1 HOLE + 150MM CLAMP
120MM H 25MM



METAL CEILING ROSE

Finish: **BLACK**

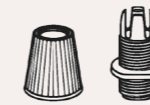

Plastic Cable Clamps

Code: **PC1SER02**



Metal Cable Clamps

Code: **SERM1NE**

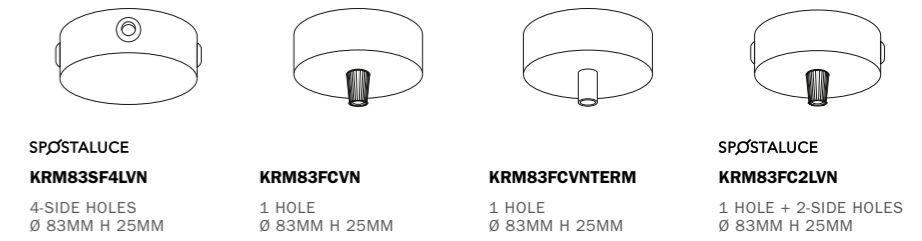

SPØSTALUCE
KRM83SF4LVN
4-SIDE HOLES
Ø 83MM H 25MM

KRM83FCVN
1 HOLE
Ø 83MM H 25MM

KRM83FCVNTERM
1 HOLE
Ø 83MM H 25MM

SPØSTALUCE
KRM83FC2LVN
1 HOLE + 2-SIDE HOLES
Ø 83MM H 25MM

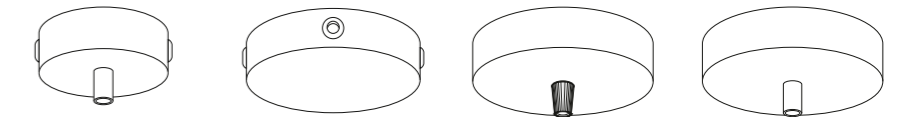

SPØSTALUCE
KRM83FC2LVNTERM
1 HOLE + 2-SIDE HOLES
Ø 83MM H 25MM

SPØSTALUCE
KRM12SF4LVN
4-SIDE HOLES
Ø 120MM H 25MM

KRM57FCVN
1 HOLE
Ø 120MM H 25MM

KRM57FCVNTERM
1 HOLE
Ø 120MM H 25MM

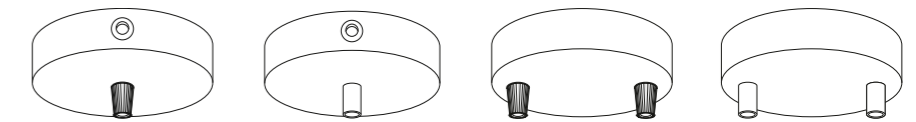

SPØSTALUCE
KRM12FC2LVN
1 HOLE + 2-SIDE HOLES
Ø 120MM H 25MM

SPØSTALUCE
KRM12FC2LVNTERM
1 HOLE + 2-SIDE HOLES
Ø 120MM H 25MM

KRM572FVN
2 HOLE
Ø 120MM H 25MM

KRM572FVNTERM
2 HOLE
Ø 120MM H 25MM

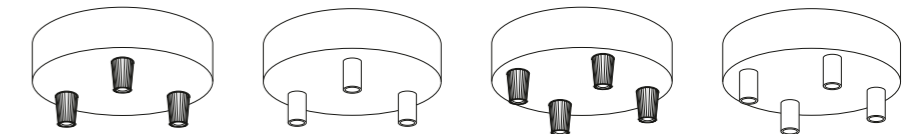

KRM573FVN
3 HOLE
Ø 120MM H 25MM

KRM573FVNTERM
3 HOLE
Ø 120MM H 25MM

KRM574FVN
4 HOLE
Ø 120MM H 25MM

KRM574FVNTERM
4 HOLE
Ø 120MM H 25MM

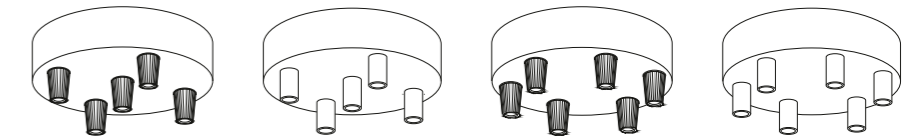

KRM575FVN
5 HOLE
Ø 120MM H 25MM

KRM575FVNTERM
5 HOLE
Ø 120MM H 25MM

KRM126FVN
6 HOLE
Ø 120MM H 25MM

KRM126FVNTERM
6 HOLE
Ø 120MM H 25MM

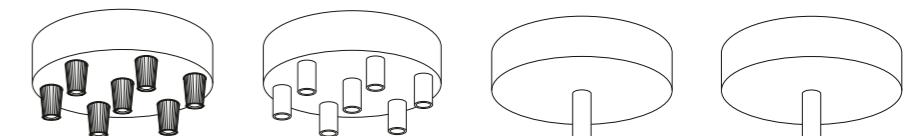

KRM576FVN
7 HOLE
Ø 120MM H 25MM

KRM576FVNTERM
7 HOLE
Ø 120MM H 25MM

KRM57FCVNTERM4
1 HOLE + 70MM CLAMP
Ø 120MM H 25MM

KRM57FCVNTERM5
1 HOLE + 150MM CLAMP
120MM H 25MM



METAL CEILING ROSE

Finish: **CHROME**

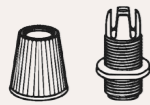

Plastic Cable Clamps

Code: **PC1SER00**



Metal Cable Clamps

Code: **SERM1CR**

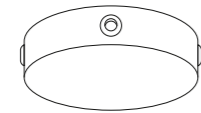

SPØSTALUCE
KRM12SF4LCR
4-SIDE HOLES
Ø 120MM H 25MM

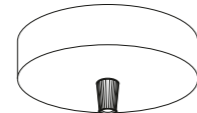

KRM57FCR
1 HOLE
Ø 120MM H 25MM

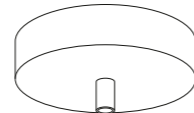

KRM57FCRTERM
1 HOLE
Ø 120MM H 25MM

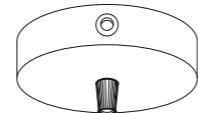

SPØSTALUCE
KRM12FC2LCR
1 HOLE + 2-SIDE HOLES
Ø 120MM H 25MM

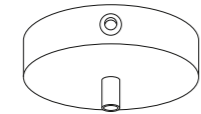

SPØSTALUCE
KRM12FC2LCRTERM
1 HOLE + 2-SIDE HOLES
Ø 120MM H 25MM

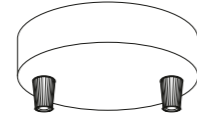

KRM572FCR
2 HOLE
Ø 120MM H 25MM

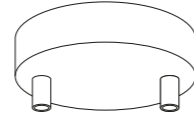

KRM572FCRTERM
2 HOLE
Ø 120MM H 25MM

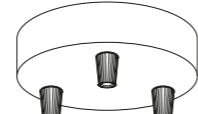

KRM573FCR
3 HOLE
Ø 120MM H 25MM

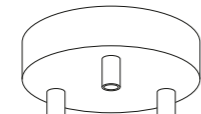

KRM573FCRTERM
3 HOLE
Ø 120MM H 25MM

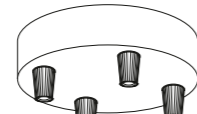

KRM574FCR
4 HOLE
Ø 120MM H 25MM

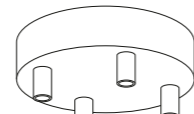

KRM574FCRTERM
4 HOLE
Ø 120MM H 25MM

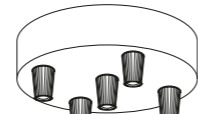

KRM575FCR
5 HOLE
Ø 120MM H 25MM

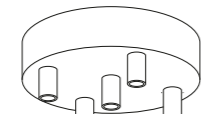

KRM575FCRTERM
5 HOLE
Ø 120MM H 25MM

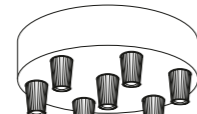

KRM576FCR
7 HOLE
Ø 120MM H 25MM



KRM576FCRTERM
7 HOLE
Ø 120MM H 25MM

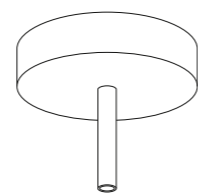

KRM57FCCR0TERM4
1 HOLE + 70MM CLAMP
Ø 120MM H 25MM

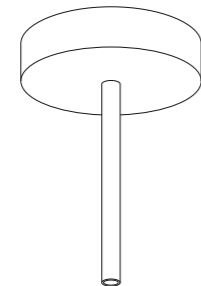

KRM57FCCR0TERM5
1 HOLE + 150MM CLAMP
120MM H 25MM



METAL CEILING ROSE

Finish: **COPPER**

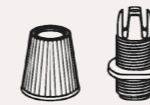

Plastic Cable Clamps

Code: **PC1SER00**



Metal Cable Clamps

Code: **SERM1RA**

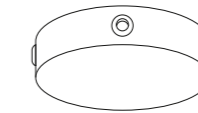

SPØSTALUCE
KRM12SF4LRA
4-SIDE HOLES
Ø 120MM H 25MM

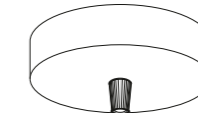

KRM57FCRA
1 HOLE
Ø 120MM H 25MM

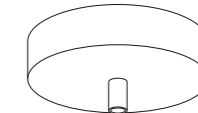

KRM57FCRATERM
1 HOLE
Ø 120MM H 25MM

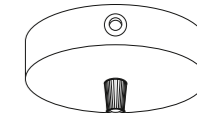

SPØSTALUCE
KRM12FC2LRA
1 HOLE + 2-SIDE HOLES
Ø 120MM H 25MM

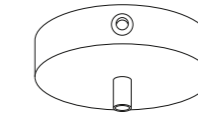

SPØSTALUCE
KRM12FC2LRATERM
1 HOLE + 2-SIDE HOLES
Ø 120MM H 25MM

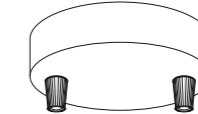

KRM572FRA
2 HOLE
Ø 120MM H 25MM

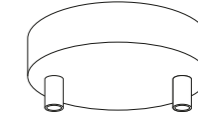

KRM572FRATERM
2 HOLE
Ø 120MM H 25MM

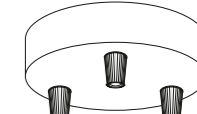

KRM573FRA
3 HOLE
Ø 120MM H 25MM

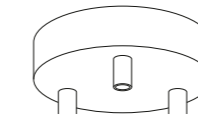

KRM573FRATERM
3 HOLE
Ø 120MM H 25MM

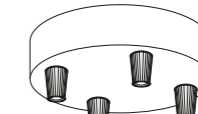

KRM574FRA
4 HOLE
Ø 120MM H 25MM

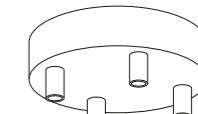

KRM574FRATERM
4 HOLE
Ø 120MM H 25MM

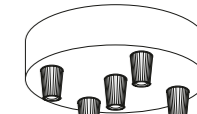

KRM575FRA
5 HOLE
Ø 120MM H 25MM

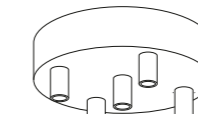

KRM575FRATERM
5 HOLE
Ø 120MM H 25MM

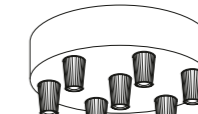

KRM576FRA
7 HOLE
Ø 120MM H 25MM

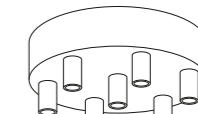

KRM576FRATERM
7 HOLE
Ø 120MM H 25MM

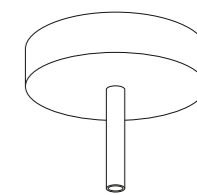

KRM57FCRA0TERM4
1 HOLE + 70MM CLAMP
Ø 120MM H 25MM

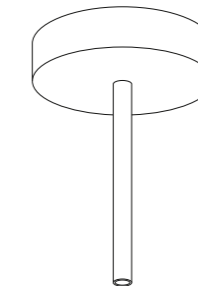

KRM57FCRA0TERM5
1 HOLE + 150MM CLAMP
120MM H 25MM



METAL CEILING ROSE

Finish: **BRASS**

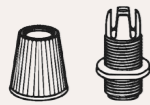

Plastic Cable Clamps

Code: **PC1SER00**



Metal Cable Clamps

Code: **SERM1GO**

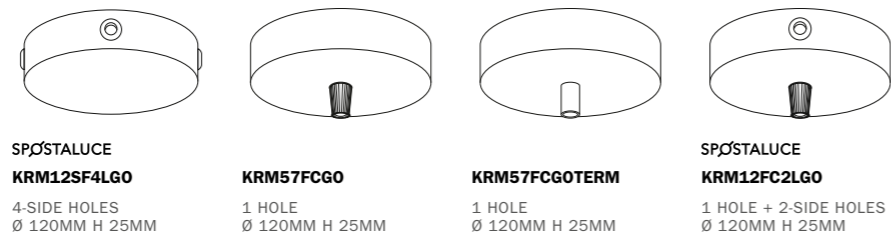

SPØSTALUCE
KRM12SF4LGO
4-SIDE HOLES
Ø 120MM H 25MM

KRM57FCGO
1 HOLE
Ø 120MM H 25MM

KRM57FCGOTERM
1 HOLE
Ø 120MM H 25MM

SPØSTALUCE
KRM12FC2LGO
1 HOLE + 2-SIDE HOLES
Ø 120MM H 25MM

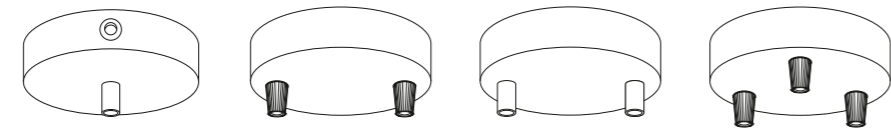

SPØSTALUCE
KRM12FC2LGO
1 HOLE + 2-SIDE HOLES
Ø 120MM H 25MM

KRM572FGO
2 HOLE
Ø 120MM H 25MM

KRM572FGOTERM
2 HOLE
Ø 120MM H 25MM

KRM573FGO
3 HOLE
Ø 120MM H 25MM

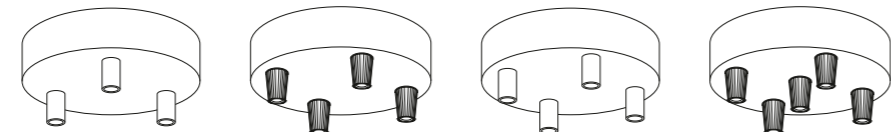

KRM573FGOTERM
3 HOLE
Ø 120MM H 25MM

KRM574FGO
4 HOLE
Ø 120MM H 25MM

KRM574FGOTERM
4 HOLE
Ø 120MM H 25MM

KRM575FGO
5 HOLE
Ø 120MM H 25MM

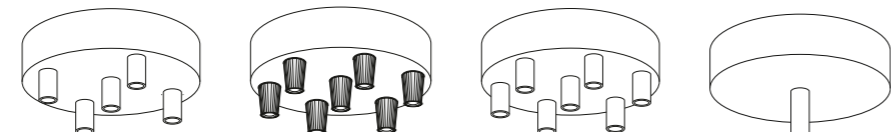

KRM575FGOTERM
5 HOLE
Ø 120MM H 25MM

KRM576FGO
7 HOLE
Ø 120MM H 25MM

KRM576FGOTERM
7 HOLE
Ø 120MM H 25MM

KRM57FCGOTERM4
1 HOLE + 70MM CLAMP
Ø 120MM H 25MM

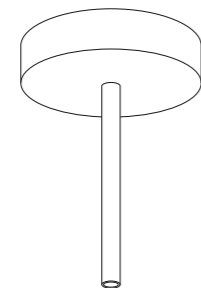

KRM57FCGOTERM5
1 HOLE + 150MM CLAMP
120MM H 25MM



METAL CEILING ROSE

Finish: **PEARL BLACK**

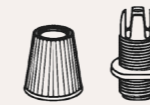

Plastic Cable Clamps

Code: **PC1SER00**



Metal Cable Clamps

Code: **SERM1BR**

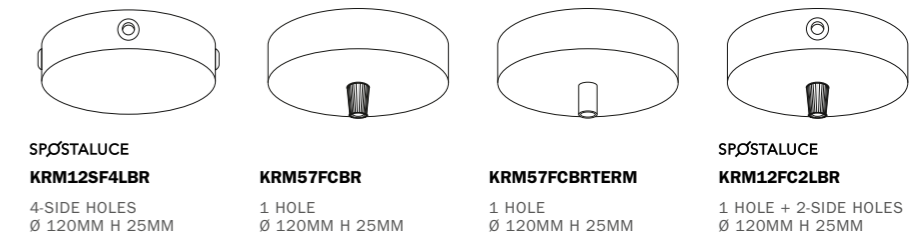

SPØSTALUCE
KRM12SF4LBR
4-SIDE HOLES
Ø 120MM H 25MM

KRM57FCBR
1 HOLE
Ø 120MM H 25MM

KRM57FCBRTERM
1 HOLE
Ø 120MM H 25MM

SPØSTALUCE
KRM12FC2LBR
1 HOLE + 2-SIDE HOLES
Ø 120MM H 25MM

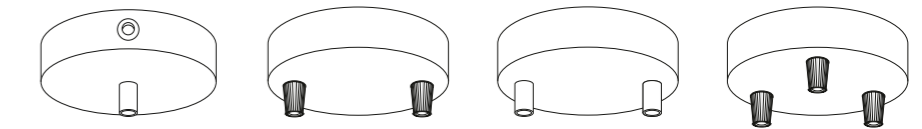

SPØSTALUCE
KRM12FC2LBRTERM
1 HOLE + 2-SIDE HOLES
Ø 120MM H 25MM

KRM572FBR
2 HOLE
Ø 120MM H 25MM

KRM572FBRTERM
2 HOLE
Ø 120MM H 25MM

KRM573FBR
3 HOLE
Ø 120MM H 25MM

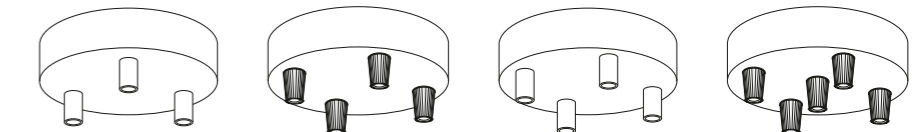

KRM573FBRTERM
3 HOLE
Ø 120MM H 25MM

KRM574FBR
4 HOLE
Ø 120MM H 25MM

KRM574FBRTERM
4 HOLE
Ø 120MM H 25MM

KRM575FBR
5 HOLE
Ø 120MM H 25MM

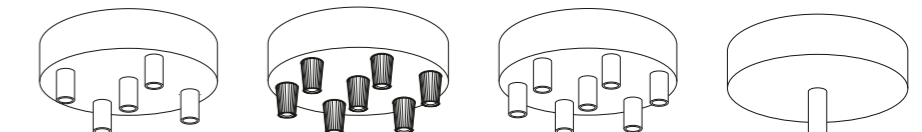

KRM575FBRTERM
5 HOLE
Ø 120MM H 25MM

KRM576FBR
7 HOLE
Ø 120MM H 25MM

KRM576FBRTERM
7 HOLE
Ø 120MM H 25MM

KRM57FCBRTERM4
1 HOLE + 70MM CLAMP
Ø 120MM H 25MM

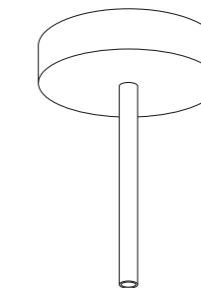

KRM57FCBRTERM5
1 HOLE + 150MM CLAMP
120MM H 25MM

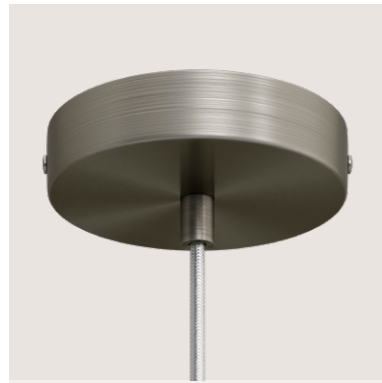

METAL CEILING ROSE

Finish: **BRUSHED TITANIUM**

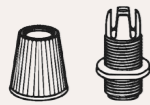

Plastic Cable Clamps

Code: **PC1SER00**



Metal Cable Clamps

Code: **SERM1TIS**

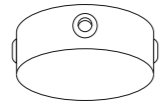

SPØSTALUCE
KRM83SF4LVTIS
4-SIDE HOLES
Ø 83MM H 25MM

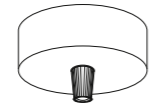

KRM83FCVTIS
1 HOLE
Ø 83MM H 25MM

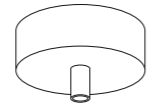

KRM83FCVTISTERM
1 HOLE
Ø 83MM H 25MM

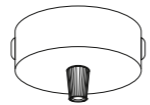

SPØSTALUCE
KRM83FC2LVTIS
1 HOLE + 2-SIDE HOLES
Ø 83MM H 25MM

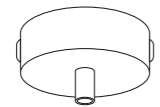

SPØSTALUCE
KRM83FC2LVTISTERM
1 HOLE + 2-SIDE HOLES
Ø 83MM H 25MM

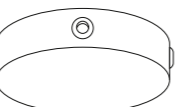

SPØSTALUCE
KRM12SF4LVTIS
4-SIDE HOLES
Ø 120MM H 25MM

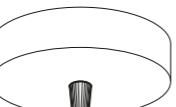

KRM57FCVTIS
1 HOLE
Ø 120MM H 25MM



KRM57FCVTISTERM
1 HOLE
Ø 120MM H 25MM

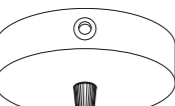

SPØSTALUCE
KRM12FC2LVTIS
1 HOLE + 2-SIDE HOLES
Ø 120MM H 25MM

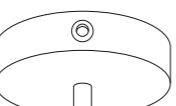

SPØSTALUCE
KRM12FC2LVTISTERM
1 HOLE + 2-SIDE HOLES
Ø 120MM H 25MM



KRM572FVTIS
2 HOLE
Ø 120MM H 25MM

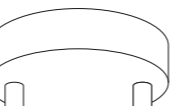

KRM572FVTISTERM
2 HOLE
Ø 120MM H 25MM

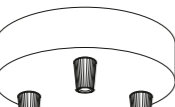

KRM573FVTIS
3 HOLE
Ø 120MM H 25MM

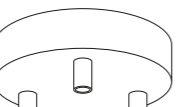

KRM573FVTISTERM
3 HOLE
Ø 120MM H 25MM



KRM574FVTIS
4 HOLE
Ø 120MM H 25MM

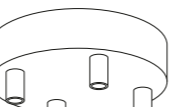

KRM574FVTISTERM
4 HOLE
Ø 120MM H 25MM

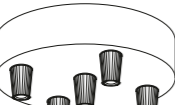

KRM575FVTIS
5 HOLE
Ø 120MM H 25MM



KRM575FVTISTERM
5 HOLE
Ø 120MM H 25MM



KRM126FVTIS
6 HOLE
Ø 120MM H 25MM

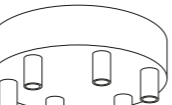

KRM126FVTISTERM
6 HOLE
Ø 120MM H 25MM

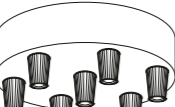

KRM576FVTIS
7 HOLE
Ø 120MM H 25MM



KRM576FVTISTERM
7 HOLE
Ø 120MM H 25MM

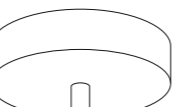

KRM57FCVTISTERM4
1 HOLE + 70MM CLAMP
Ø 120MM H 25MM

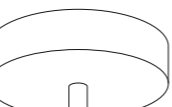

KRM57FCVTISTERM5
1 HOLE + 150MM CLAMP
120MM H 25MM

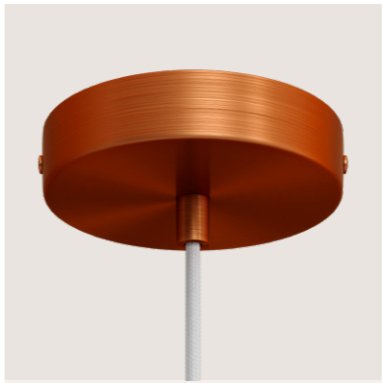

METAL CEILING ROSE

Finish: **BRUSHED COPPER**

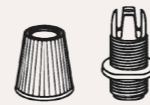

Plastic Cable Clamps

Code: **PC1SER00**



Metal Cable Clamps

Code: **SERM1RAS**

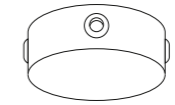

SPØSTALUCE
KRM83SF4LRAS
4-SIDE HOLES
Ø 83MM H 25MM

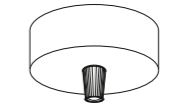

KRM83FCRAS
1 HOLE
Ø 83MM H 25MM

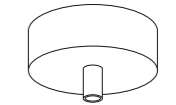

KRM83FCRASTERM
1 HOLE
Ø 83MM H 25MM

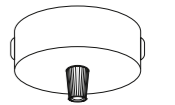

SPØSTALUCE
KRM83FC2LRAS
1 HOLE + 2-SIDE HOLES
Ø 83MM H 25MM

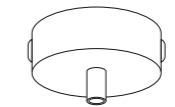

SPØSTALUCE
KRM83FC2LRASTERM
1 HOLE + 2-SIDE HOLES
Ø 83MM H 25MM

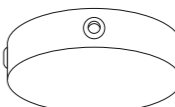

SPØSTALUCE
KRM12SF4LRAS
4-SIDE HOLES
Ø 120MM H 25MM

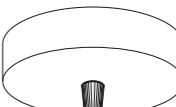

KRM57FCRAS
1 HOLE
Ø 120MM H 25MM



KRM57FCRASTERM
1 HOLE
Ø 120MM H 25MM

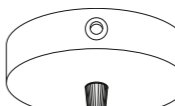

SPØSTALUCE
KRM12FC2LRAS
1 HOLE + 2-SIDE HOLES
Ø 120MM H 25MM

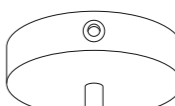

SPØSTALUCE
KRM12FC2LRASTERM
1 HOLE + 2-SIDE HOLES
Ø 120MM H 25MM



KRM572FRAS
2 HOLE
Ø 120MM H 25MM

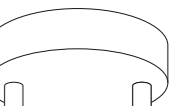

KRM572FRASTERM
2 HOLE
Ø 120MM H 25MM

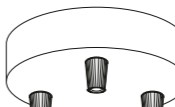

KRM573FRAS
3 HOLE
Ø 120MM H 25MM

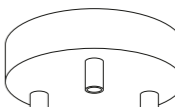

KRM573FRASTERM
3 HOLE
Ø 120MM H 25MM

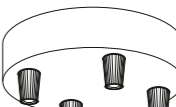

KRM574FRAS
4 HOLE
Ø 120MM H 25MM



KRM574FRASTERM
4 HOLE
Ø 120MM H 25MM

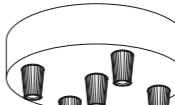

KRM575FRAS
5 HOLE
Ø 120MM H 25MM



KRM575FRASTERM
5 HOLE
Ø 120MM H 25MM



KRM126FRAS
6 HOLE
Ø 120MM H 25MM

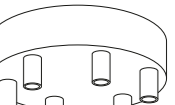

KRM126FRASTERM
6 HOLE
Ø 120MM H 25MM

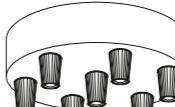

KRM576FRAS
7 HOLE
Ø 120MM H 25MM

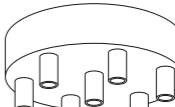

KRM576FRASTERM
7 HOLE
Ø 120MM H 25MM

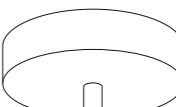

KRM57FCRASTERM4
1 HOLE + 70MM CLAMP
Ø 120MM H 25MM

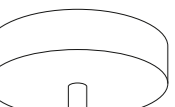

KRM57FCRASTERM5
1 HOLE + 150MM CLAMP
120MM H 25MM

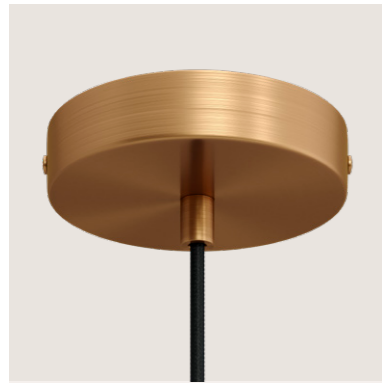

METAL CEILING ROSE

Finish: **BRUSHED BRASS**

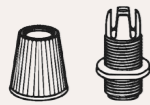

Plastic Cable Clamps

Code: **PC1SER00**



Metal Cable Clamps

Code: **SERM10TS**

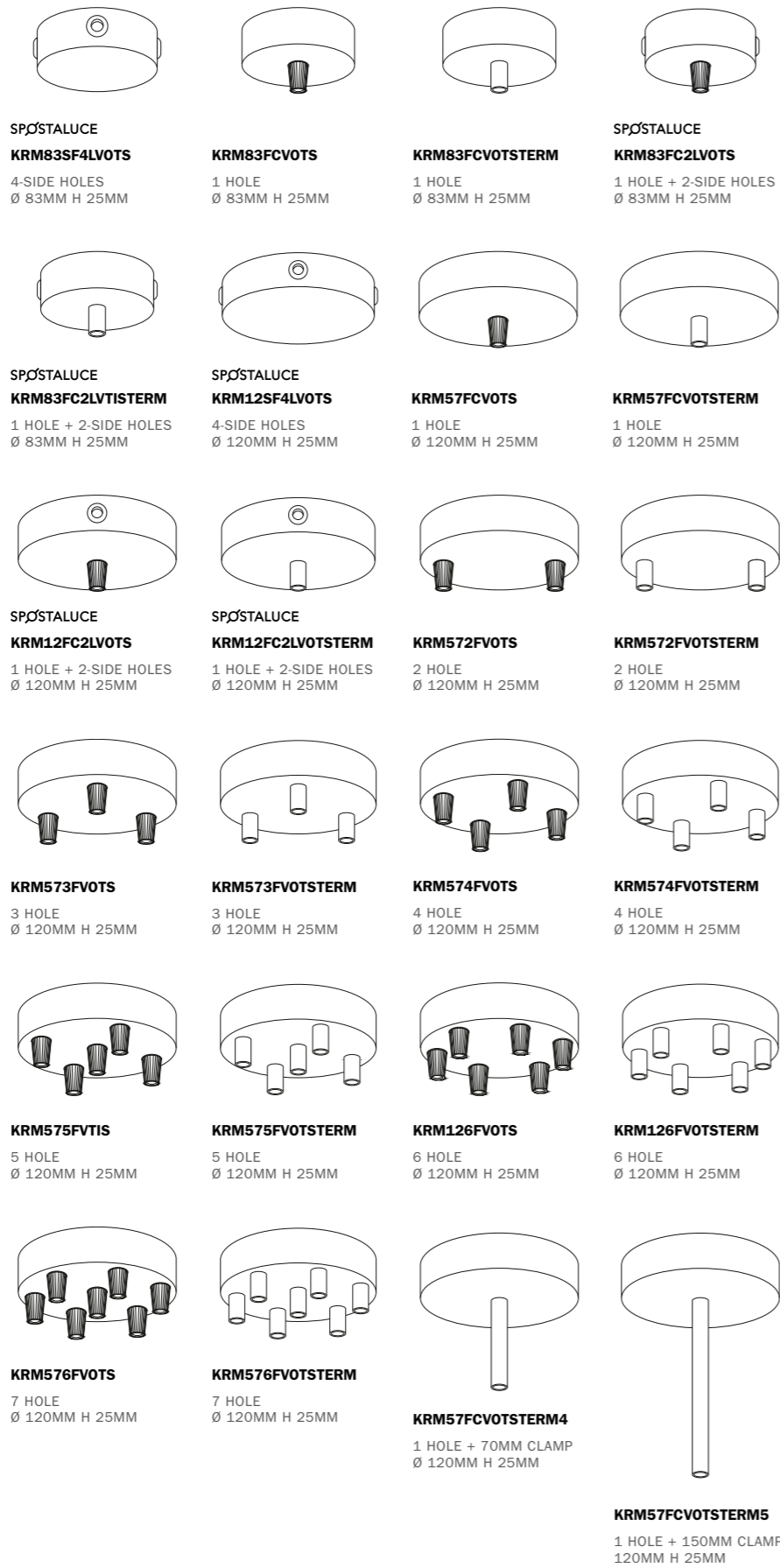

METAL CEILING ROSE

Finish: **DARK RUST**



Metal Cable Clamps

Code: **SERM1RU**



Plastic Cable Clamps

Code: **PC1SER00**

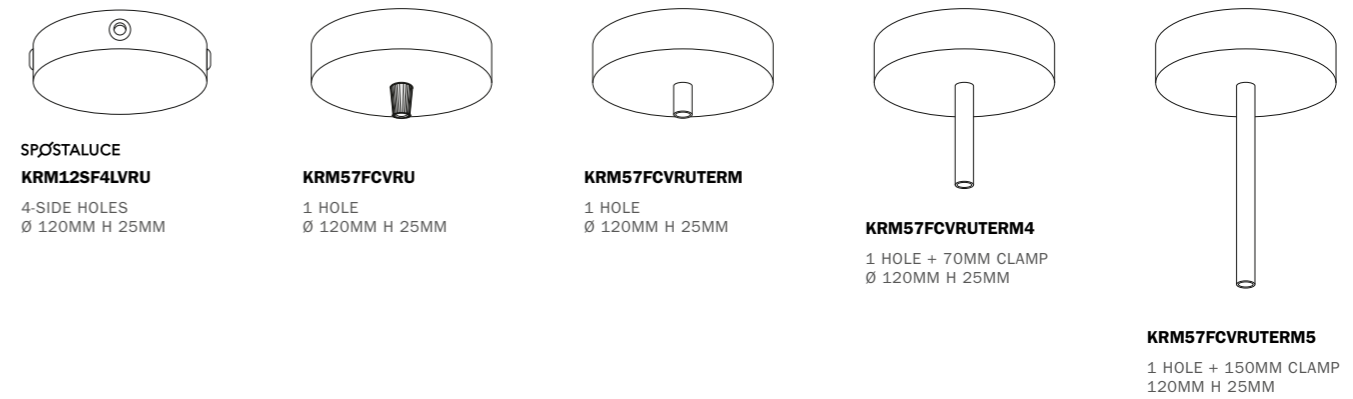
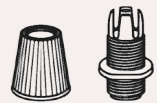

Flush-mounted ceiling rose



Flush-mounted ceiling rose

Cover Material: **Metal**
 Hole diameter: **10mm**
 Cable Clamp: **Cylindrical**

CE
UK
CA

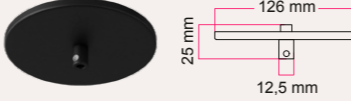

Finish	Code
● Matt White	KRM126FFCVBO
● Black	KRM126FFCVN

Metal painted ceiling rose



Half-sphere ceiling rose kit

Cover Material: **Metal**
 Hole diameter: **10mm**
 Cable Clamp: **Plastic Conical**

CE
UK
CA



Finish	Code
● Glossy White	25902
● Black	25909
● Chrome	25900
● Light Blue	25907
● Red	25905

Mini metal cylindrical rose kit with switch



Mini cylindrical rose kit with switch

Material: **Metal**
 Hole diameter: **10mm**
 Cable clamp:

CE
UK
CA



Finish	Code
● Matt White	KRM83FCSWVBO
● Black	KRM83FCSWVN
● Brushed Titanium	KRM83FCSWTIS
● Brushed Bronze	KRM83FCSWOTS
● Brushed Copper	KRM83FCSWRAS

SILICONE CEILING ROSES

Colourful, vibrant and striking: this ceiling rose combines creativity and functionality. With the arrangement for a side hole, you can connect two roses or position the lamp away from any light source by simply adding a plug and cable.



Silicone rose kit

Cover Material: **Silicon**
 Hole diameter: **10mm**
 Cable Clamp: **Hidden**

CE
UK
CA

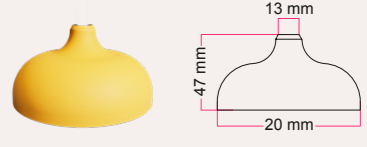

Finish	Code	Finish	Code
● White	KROSSIBIA	● Petrol	KROSSIPE
● Black	KROSSINER	● Soft Blue	KROSSISB
● Grey	KROSSIGRI	● Soft Green	KROSSIVE
● Desert Brown	KROSSIDB	● Salmon	KROSSISAL
● Yellow Mustard	KROSSIMU	● Red	KROSSIRSS
● Yellow	KROSSIGIA	● Orange	KROSSIARA

SPÓSTALUCE

EIVA Cylindrical outdoor ceiling rose

Cover Material: **Soft touch silicone**
 Hole diameter: **10mm**
 Cable Clamp: **included**

CE
UK
CA

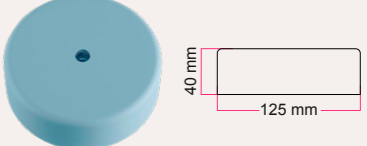

Finish	Code	Finish	Code
● White	KEIVAROSBI	● Soft blue	KEIVAPASB
● Black	KEIVAROSBK	● Soft green	KEIVAROSVE
● Glacier Grey	KEIVAROSGG	● Mustard yellow	KEIVAPAMU
● Petrol	KEIVAROSPE	● Salmon	KEIVAPASAL

IP65 WATERPROOF

WOODEN CEILING ROSES

We produce our wooden components in a small workshop in the province of Turin, our hometown. Here, the distinctive Italian craftsmanship, care and creativity of our designers transforms every wood log into beautiful components.

We first designed them for our rope cables and offered in three basic colours, but they are so extremely versatile that we've created more options to give you more possibilities to style your interior as you prefer: natural wood can be painted or polished as desired. Each ceiling rose has a matching wooden lamp holder.

120mm Diameter



Wooden ceiling rose kit

Cover Material: **Wood**
Hole diameter: **10mm**
Cable Clamp: **Hidden**

CE
UK
CA
MADE IN ITALY

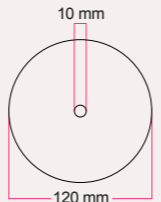

Finish	Code
White	KRL0210
Black	KRL0310
Wenge Effect	KRL0410
Neutral	KRL0110



Oval ceiling rose kit

Cover Material: **Wood**
Hole diameter: **10mm**
Cable Clamp: **Hidden**

CE
UK
CA
MADE IN ITALY

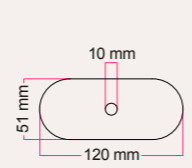

Finish	Code
White	KRL1210
Black	KRL1310
Neutral	KRL1110





Cylindrical 4-hole ceiling rose kit

Cover Material: **Wood**
Hole diameter: **10mm**
Cable Clamp: **Hidden**

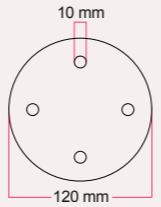
CE
UK
CA
MADE IN ITALY

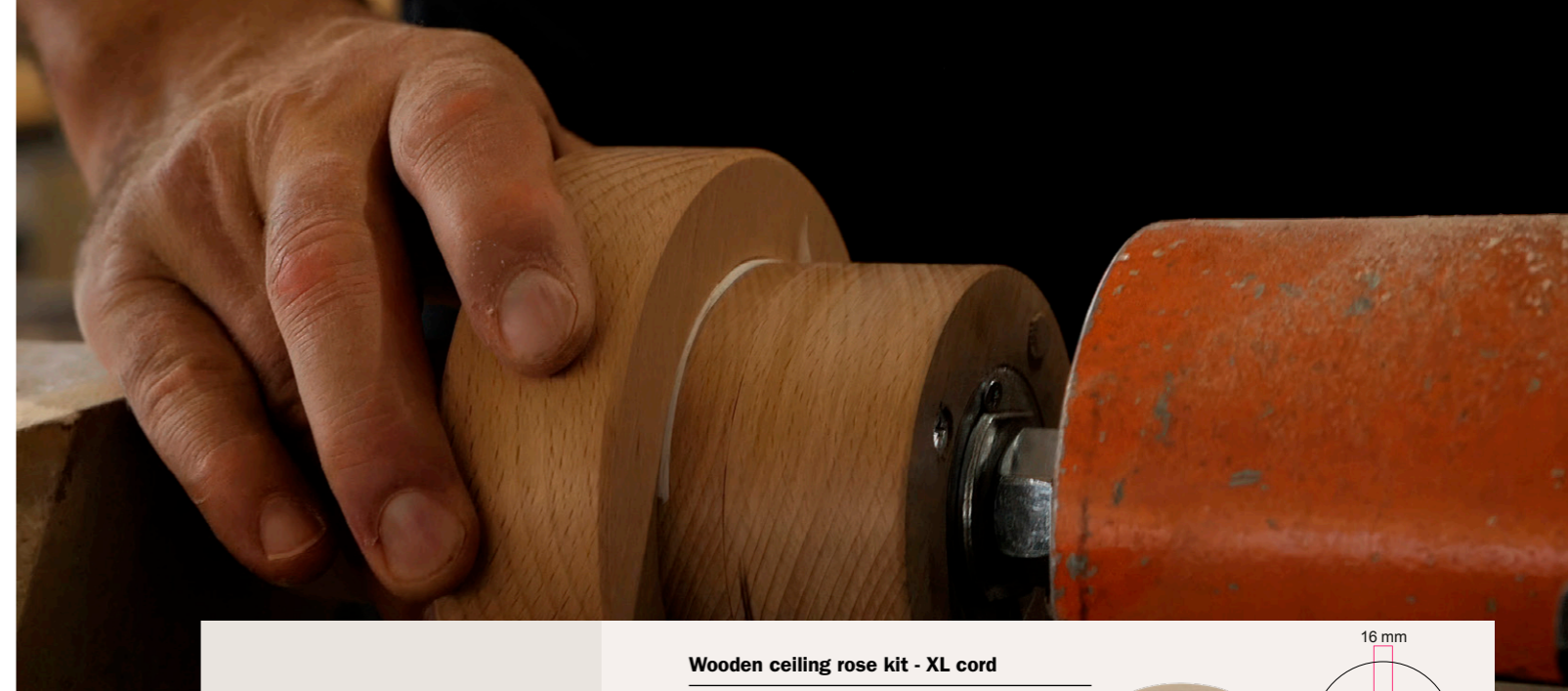

Finish	Code
Wenge Effect	KRL4F0410
Neutral	KRL4F0110

Wooden ceiling rose kit - XL cord

Cover Material: **Wood**
Hole diameter: **16mm**
Cable Clamp: **Hidden**

CE
UK
CA
MADE IN ITALY

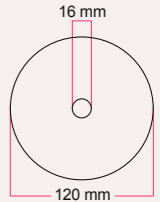

Finish	Code
White	KRL0216
Black	KRL0316
Neutral	KRL0116

*Compatible with XL rope cables (16mm)



Wooden ceiling rose kit - 2XL cord

Cover Material: **Wood**
Hole diameter: **24mm**
Cable Clamp: **Hidden**

CE
UK
CA
MADE IN ITALY

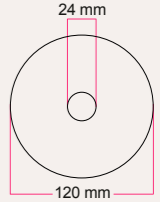

Finish	Code
White	KRL0224
Black	KRL0324
Neutral	KRL0124

*Compatible with 2XL rope cables (24mm)



Wooden ceiling rose kit - 3XL cord

Cover Material: **Wood**
Hole diameter: **30mm**
Cable Clamp: **Hidden**

CE
UK
CA
MADE IN ITALY

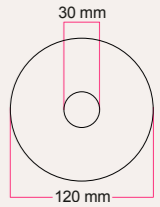

Finish	Code
White	KRL0230
Black	KRL0330
Neutral	KRL0130

*Compatible with 3XL rope cables (30mm)

88mm Diameter



Wooden ceiling rose kit

Material: **Wood**
 Hole diameter: **10mm**
 Sizes: **ø 88, H 30mm**

CE
 UK
 CA
 MADE IN ITALY

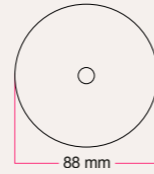

Finish

Code

- | | |
|----------------|-----------|
| ● Wenge Effect | KRL88FC04 |
| ● Neutral | KRL88FC01 |



Kit Mini cylindrical rose

Material: **Wood**
 Hole diameter: **10mm**
 Cable Clamp: **Hidden**

CE
 UK
 CA
 MADE IN ITALY



Finish

Code

- | | |
|-----------|-------------|
| ● Neutral | KRL88FC2L01 |
|-----------|-------------|

SPØSTALUCE

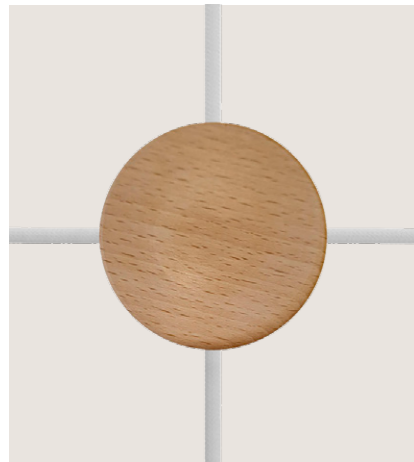

Mini cylindrical ceiling rose kit

Material: **Wood**
 Hole diameter: **10mm**
 Cable Clamp: **Hidden**

CE
 UK
 CA
 MADE IN ITALY

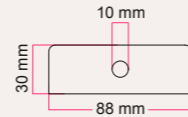

Finish

Code

- | | |
|-----------|-------------|
| ● Neutral | KRL88SF4L01 |
|-----------|-------------|

SPØSTALUCE



PORCELAIN CEILING ROSES

Porcelain is a timeless classic and is an elegant solution that will make your wall or ceiling lamps absolutely unique. Each ceiling rose has a matching porcelain lamp holder.





Porcelain ceiling rose kit

Cover Material: **Porcelain** CE
 Hole diameter: **10mm**
 Cable Clamp: **Hidden**

Finish **Code**

● White	25923	● Green	KRSPVER
● Black	KRSPNER	● Sage green	KRSPVERDE
● Grey	KRSPGRI	● Red	KRSPROS
● Yellow	KRSPGIA	● Ancient pink	KRSPROSA
● Light Blue	KRSPAZZ		

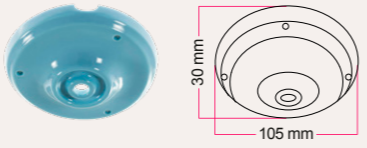
SPØSTALUCE

Porcelain Minimal ceiling rose kit

Cover Material: **Porcelain** CE
 Hole diameter: **10mm**
 Cable Clamp: **Hidden**

Finish **Code**

● Black	KRSP2NER
● White	KRSP2BIA

SPØSTALUCE

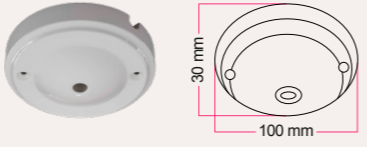

CERAMIC CEILING ROSES

These rosettes are hand-made in Italy: each piece is unique! Due to their natural look, they are perfect for a country or shabby chic home. Each ceiling rose has a matching ceramic lamp holder.





Ceramic 7-hole ceiling rose

Cover Material: **Ceramic** CE
 Hole diameter: **11mm**
 Cable Clamp: **Conical**

Finish **Code**

● White	83-RC001	● Blue	83-RC008
● Black	83-RC013	● Purple	83-RC004
● Grey	83-RC005	● Lilac	83-RC003
● Cookie	83-RC000	● Burgundy	83-RC009
● Ivory	83-RC002	● Red	83-RC007
● Yellow	83-RC012	● Orange	83-RC006
● Pistachio Green	83-RC011	● Tangerine	83-RC010

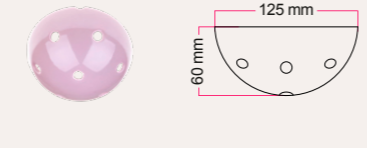
MADE IN ITALY

Ceramic mini ceiling rose

Cover Material: **Ceramic** CE
 Hole diameter: **11mm**
 Cable Clamp: **Conical**

Finish **Code**

● Craquelet effect	KR44157F
● White	KR44152F
● White - Brown	KR44159F
● White - Orange	KR44153F

MADE IN ITALY





Ceramic simple ceiling rose

Cover Material: **Ceramic** CE
 Hole diameter: **10mm**
 Cable Clamp: **Hidden**

Finish **Code**

● Craquelet effect	KR44167F
● White	KR44162F

MADE IN ITALY

Ceramic 2-hole ceiling rose

Cover Material: **Ceramic** CE
 Hole diameter: **11mm**
 Cable Clamp: **Hidden**

Finish **Code**

● White	KR73166F
---------	----------

MADE IN ITALY

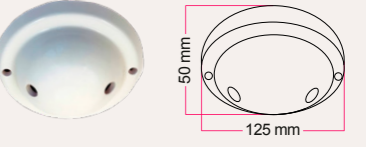



ROSE-ONE

The first versatile and easily customizable ceiling rose. Create unique multi-pendant lamps with ROSE-ONE ceiling roses.

Rose-One System is a Creative Cables exclusive solution allowing everyone to create wonderful multi-pendant lamps personalized on each one's needs.

Invest with limited stock

Keep your stock limited without reducing the number of products you can sell. You can easily create your product combining the Rose-One bases with covers either already drilled or to be drilled.

Flexible and customizable solution

With Rose-One you will have the possibility to customize the product independently, defining the number and position of the pendant holes selected by your customer.

Wide choice of shapes, colors and finishes

You can choose from many combinations, which differ in shape, size, color or finish. If the available options are not enough you can request a custom finish!

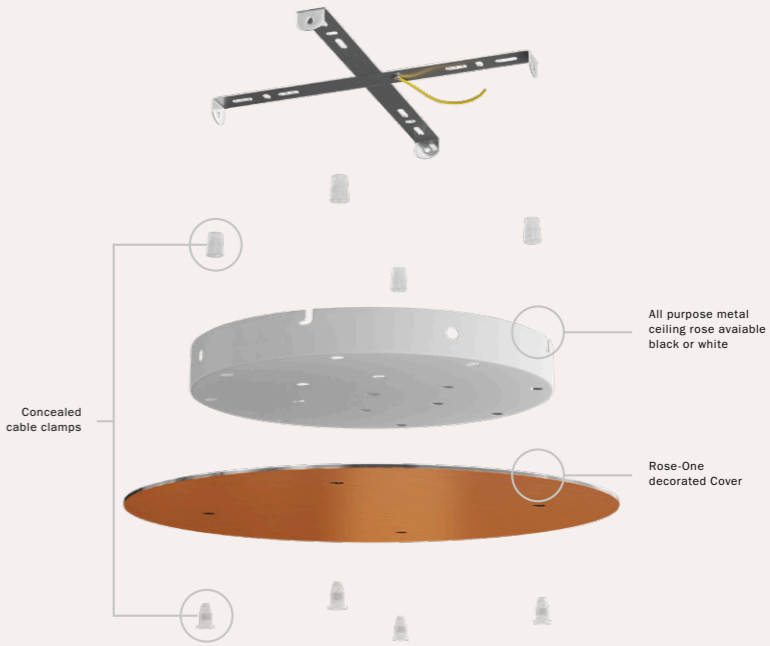

Patented Solution
MADE IN ITALY

Compatible with
SPØSTALUCE



Round, square or rectangular

With the Rose-One system, you can choose from a variety of shapes and sizes to find the rose that's right for you.

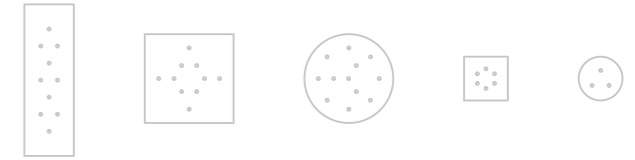

Colors and finishes: Matt, Textured or Metallic?

Your Rose-One can be understated and elegant or informal and playful; take a look at our colorful decorations!

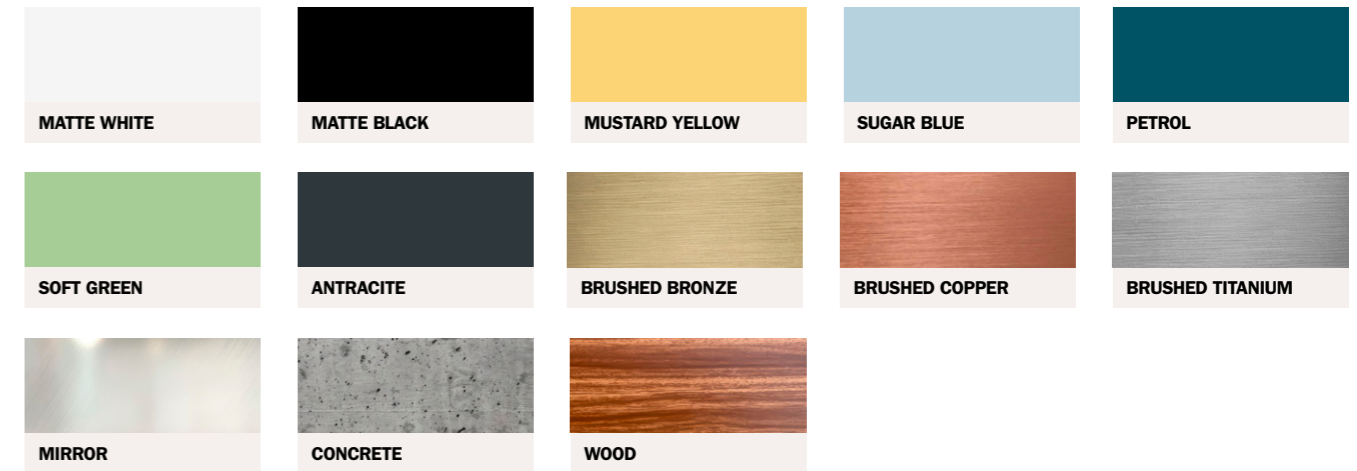

Numbers of pendants: how many?

Our catalogue has a range of Rose-One options from 1 up to 15 holes to choose from, to make an installation with many pendants! In addition, custom roses can be made with the number and geometry of holes that your customer prefers.

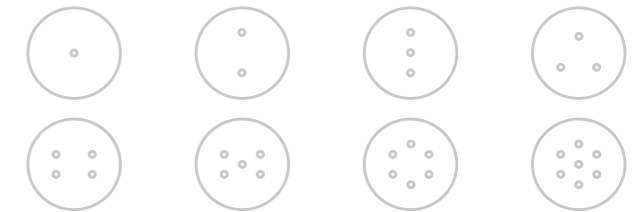

Base holes: We have 4 options

The Rose-One by Creative Cables is a Made in Italy patented solution that is characterized by a base with four entry/exit holes. How can you use them?

- Create up to 4 side drops in addition to those present in the cover of the Rose-One.
- Connect multiple Rose-Ones together to illuminate areas of the room away from possible points of power sources.
- If there is no ceiling light you can use the side holes to connect the Rose-One to a nearby electrical outlet.

If the 4 holes of the base are not used, they can be closed with the caps provided in the package.



Multiple arrangements

The Rose-One rectangular or square, thanks to the many finishes available allows you to create multiple impressive suspensions in relation with the style of the rooms you are furnishing.

The side holes allow you to easily connect several Rose-One to each other, starting from a single ceiling light point. They can be easily combined with each other to allow you to create different arrangements and geometric designs adaptable to your needs: lighting a living room, a table or a long bar counter.

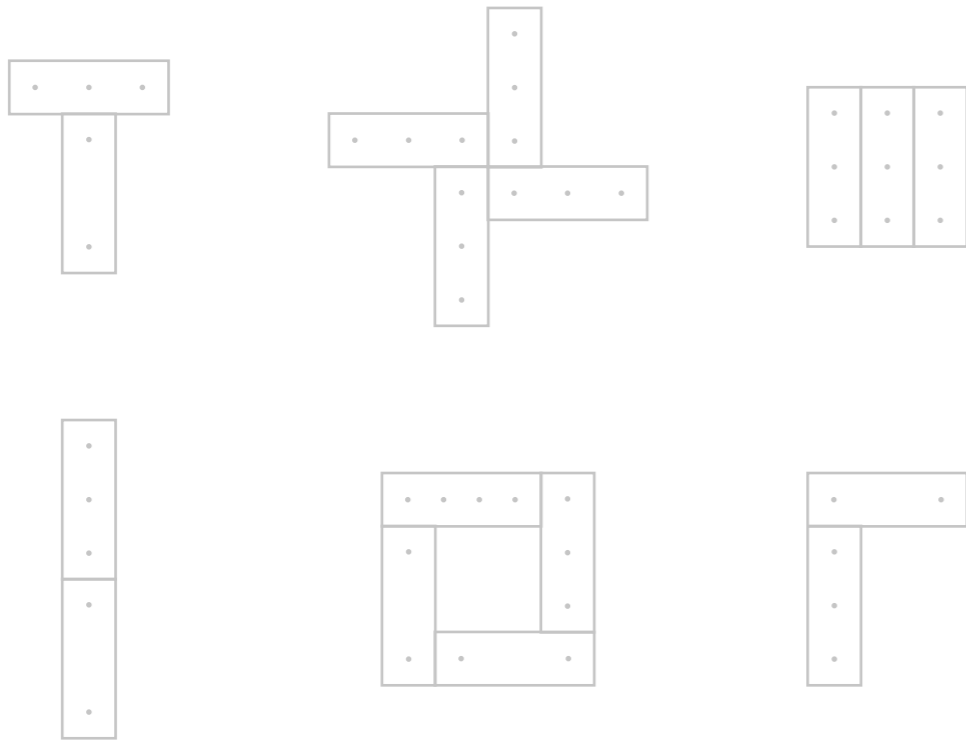

Rose-One: the customizable ceiling rose

With our template you can drill any round or square Rose-One cover in your shop with a common drill.

The holes are numbered to make drilling easier: if you want, you can use our legend to reproduce the most classic drilling patterns (included in every pack).

Unlike a classic range of rosettes, it will not be necessary to stock an infinite number of models, different in the number of holes and finishes: depending on customers requirements, you can create the desired product by combining the universal base to the dibond, already drilled or to be drilled with the appropriate template jig.

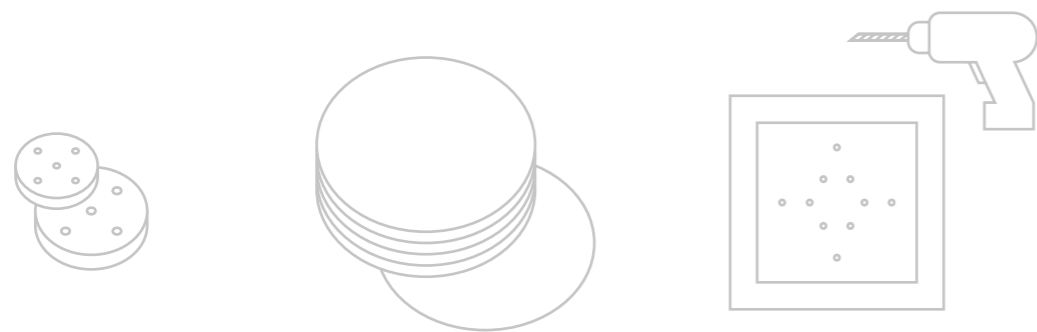

Rose-One kits

For all our customers who like to create and design, being able to choose your ceiling rose for single or multi pendant lights just got a whole lot easier. Rose-One system comes in a wide variety of colors and design options. Look out for more options to come.

Round small - 200mm

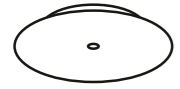

KRO R 20 1F

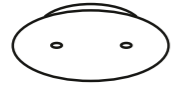

KRO R 20 2F

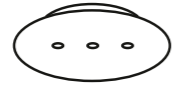

KRO R 20 3LF
SPÓSTALUCE

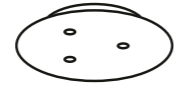

KRO R 20 3TF

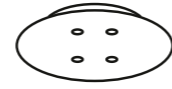

KRO R 20 4F

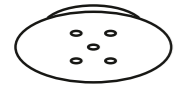

KRO R 20 5F

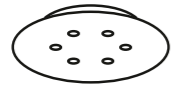

KRO R 20 6F

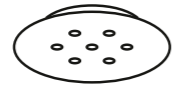

KRO R 20 7F

Round large - 400mm

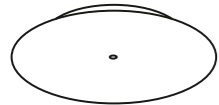

KRO R 40 1F

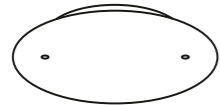

KRO R 40 2F

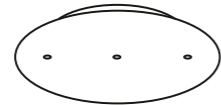

KRO R 40 3LF

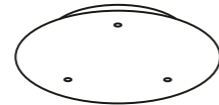

KRO R 40 3TF

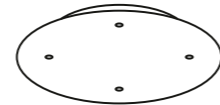

KRO R 40 4F

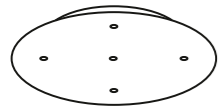

KRO R 40 5PF

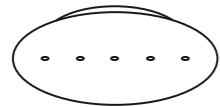

KRO R 40 5LF

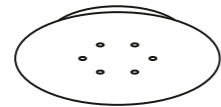

KRO R 40 6F

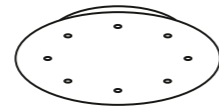

KRO R 40 8F

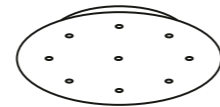

KRO R 40 9EF

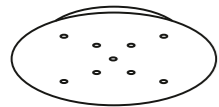

KRO R 40 9XF

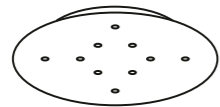

KRO R 40 10F

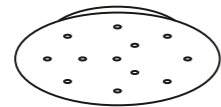

KRO R 40 12F

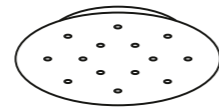

KRO R 40 14F

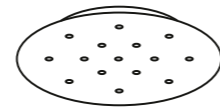

KRO R 40 15F

How to compose the product code



KRO ROSE-ONE KIT	R ROUND	20 Ø	3LF HOLES	103 DECORATION
----------------------------	-------------------	----------------	---------------------	--------------------------



KRO ROSE-ONE KIT	R ROUND	VN C.R. COLOR	40 Ø	9EF HOLES	102 DECORATION
----------------------------	-------------------	-------------------------	----------------	---------------------	--------------------------

DIBOND® ROSE-ONE 3 HOLES FINISHES

Finish	Code
● Matt White	KROR203LF102
● Matt Black	KROR203EF103
● Anthracite	KROR203LF111
● Concrete	KROR203LF106
● Satin Steel	KROR203LF109
● Marble Carrara	KROR203LF105
● Mirror	KROR203LF112
● Petrol	KROR203LF115
● Soft blue	KROR203LF114
● Soft green	KROR203LF116
● Mustard yellow	KROR203LF113
● Satin Brass	KROR203LF107
● Satin Copper	KROR203LF108
● Wood	KROR203LF110

DIBOND® ROSE-ONE 9 HOLES FINISHES

Finish	Code
● Matt White	KROR409EF102
● Matt Black	KROR409EF103
● Anthracite	KROR409EF111
● Concrete	KROR409EF106
● Satin Steel	KROR409EF109
● Marble Carrara	KROR409EF105
● Mirror	KROR409EF112
● Petrol	KROR409EF115
● Soft blue	KROR409EF114
● Soft green	KROR409EF116
● Mustard yellow	KROR409EF113
● Satin Brass	KROR409EF107
● Satin Copper	KROR409EF108
● Wood	KROR409EF110

Square small - 200mm

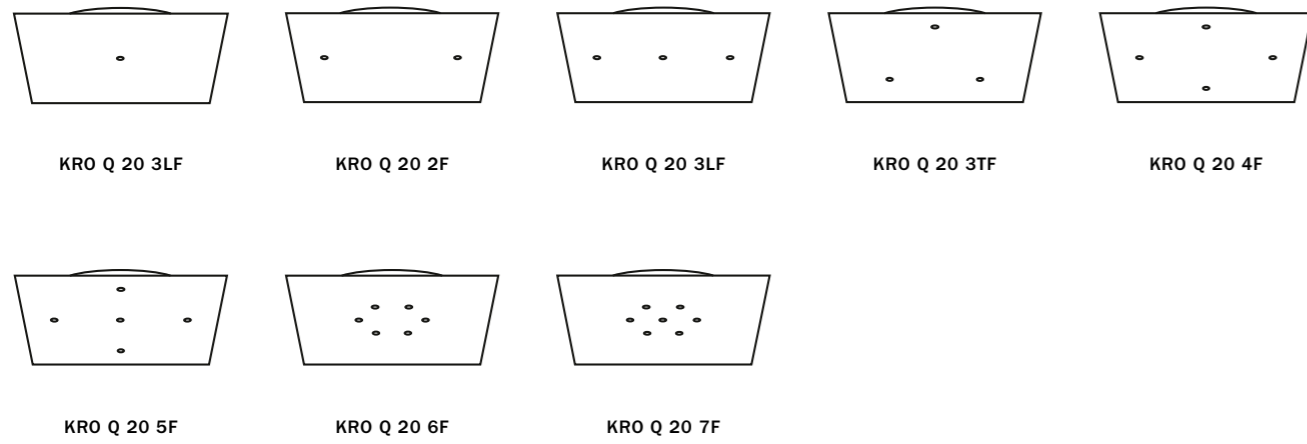

Square large - 400mm

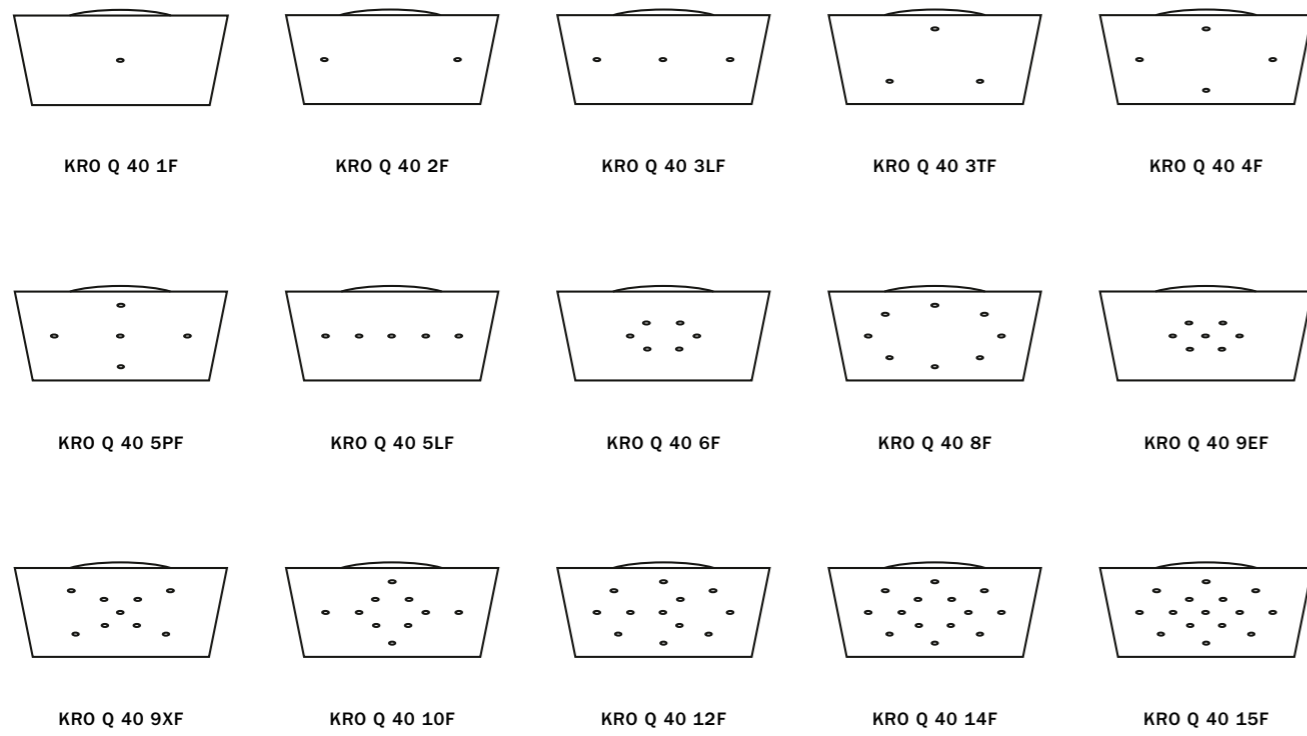

How to compose the product code



KRO ROSE-ONE KIT	Q SQUARE	20 L	5F HOLES	103 DECORATION
----------------------------	--------------------	----------------	--------------------	--------------------------

KRO ROSE-ONE KIT	Q SQUARE	VN C.R. COLOR	40 L	8F HOLES	102 DECORATION
----------------------------	--------------------	-------------------------	----------------	--------------------	--------------------------

DIBOND® ROSE-ONE 5 HOLES FINISHES

Finish	Code
● Matt White	KROQ205F102
● Matt Black	KROQ205F103
● Marble Marquina	KROQ205F104
● Anthracite	KROQ205F111
● Satin Steel	KROQ205F109
● Concrete	KROQ205F106
● Marble Carrara	KROQ205F105
● Mirror	KROQ205F112
● Petrol	KROQ205F115
● Soft blue	KROQ205F114
● Soft green	KROQ205F116
● Mustard yellow	KROQ205F113
● Satin Brass	KROQ205F107
● Satin Copper	KROQ205F108
● Wood	KROQ205F110

DIBOND® ROSE-ONE 9 HOLES FINISHES

Finish	Code
● Matt White	KROVNQ408F102
● Matt Black	KROVNQ408F103
● Marble Marquina	KROVNQ408F104
● Anthracite	KROVNQ408F111
● Satin Steel	KROVNQ408F109
● Concrete	KROVNQ408F106
● Marble Carrara	KROVNQ408F105
● Mirror	KROVNQ408F112
● Petrol	KROVNQ408F115
● Soft blue	KROVNQ408F114
● Soft green	KROVNQ408F116
● Mustard yellow	KROVNQ408F113
● Satin Brass	KROVNQ408F107
● Satin Copper	KROVNQ408F108
● Wood	KROVNQ408F110

Rectangular xxl 675 x 225mm

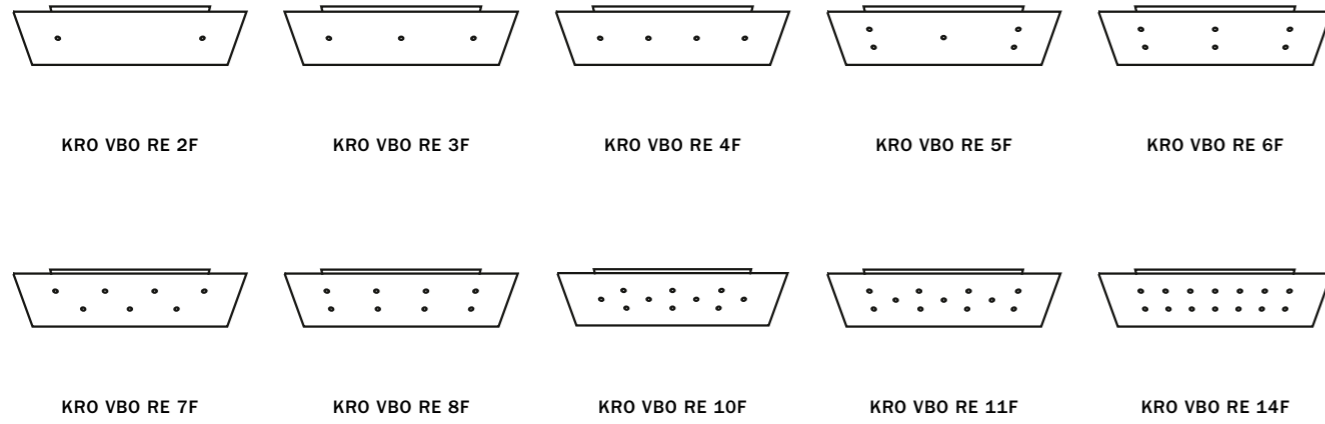

How to compose the product code

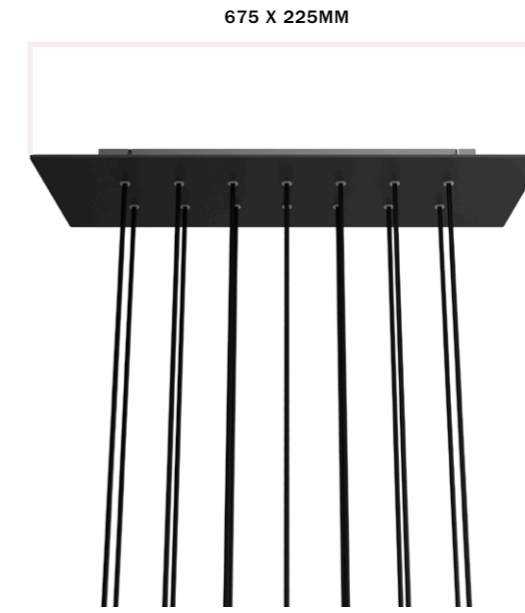

KRO ROSE-ONE KIT	VN C.R. COLOR	RE L	14F HOLES	102 DECORATION
----------------------------	-------------------------	----------------	---------------------	--------------------------

DIBOND® ROSE-ONE 14 HOLES FINISHES

Finish	Code
● Matt White	KROVBORE14F102
● Matt Black	KROVBORE14F103
● Satin Steel	KROVBORE14F109
● Satin Brass	KROVBORE14F107
● Satin Copper	KROVBORE14F108



What you need to compose your Rose-One ceiling rose

You'll be able to build your Rose-One ceiling rose in 3 simple steps. One - choose pre-drilled or undrilled cover's shape, size and Decorazione. Two - choose one of the 3 metal ceiling roses: Rotondo small for smaller covers, Rotondo big for the bigger ones and rectangular for rectangular covers. All available in white or black. Three - complete your ceiling rose with transparent hidden cable clamps. Easy not? And you can also optimize your warehouse's stock! How? Depending on your customers' requirements, you can easily create your product combining the Rose-One bases with covers either already drilled or to be drilled. A lot of choices for your Clients with a minimum stock, what do you need more?

Cover

Choose the shape, the size and the decoration. You can either buy it: predrilled or undrilled.

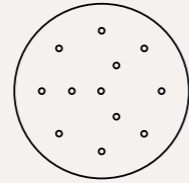

PREDRILLED

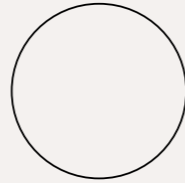

UNDRILLED

Base metal ceiling rose

Depending on the cover you chose, you will need to choose the correct one from the 3 available metal ceiling roses: round small for smaller covers, round big for bigger covers or rectangular (either white or black) for rectangular covers.

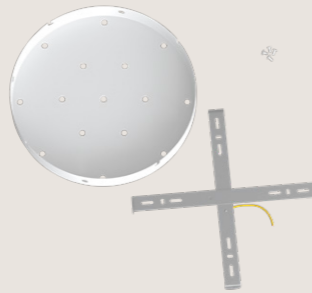

Cable clamps

Add the transparent hidden cable clamps to your cart in order to complete your ceiling rose.



Warning!

If you buy undrilled covers you will also need to buy a template in order to ensure that you drill the holes correctly.

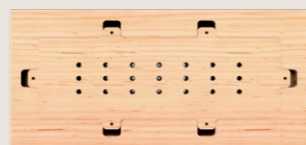
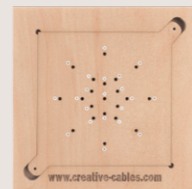

1. Pre-Drilled Covers

The Rose-One pre-drilled come in three different shapes: square, round and rectangular. And the squared and round versions are available in two different dimensions, 200 and 400mm. Covers are pre-drilled with 1 to 15 holes depending on their dimension following different kind of punching schemes. Covers come in different designs and colors and are made in aluminum or dibond. Complete the Rose-One ceiling rose with specific Material: a metal ceiling rose and cable clamps.

Round small - 200mm

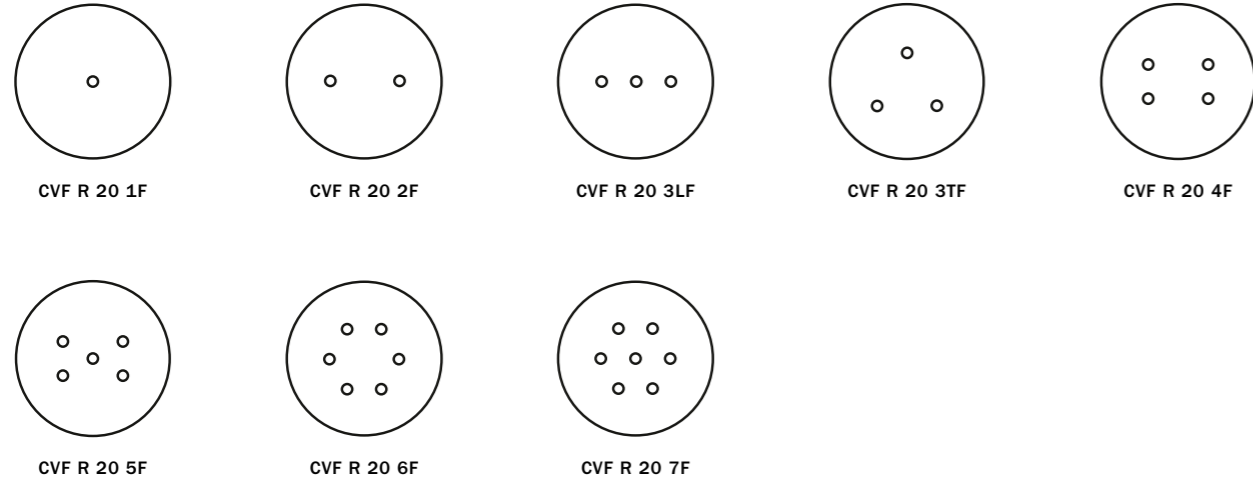

Round large - 400mm

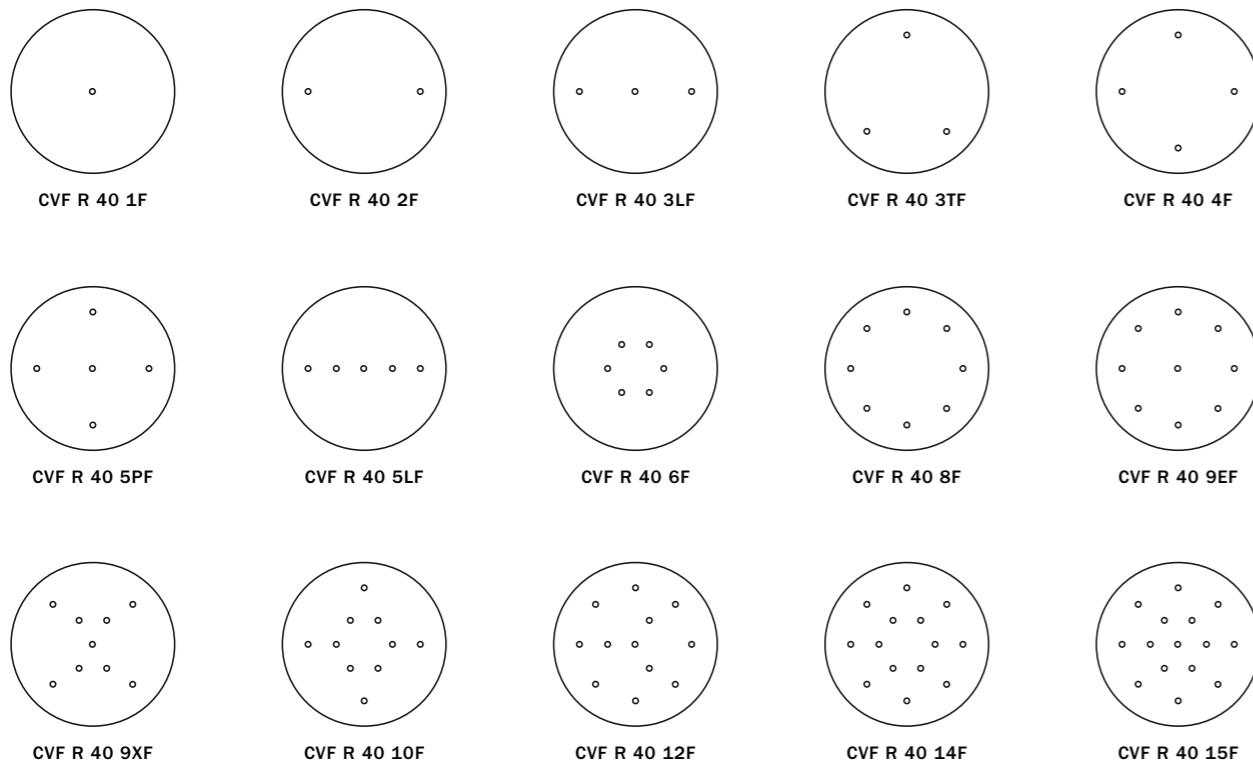

How to compose the product code

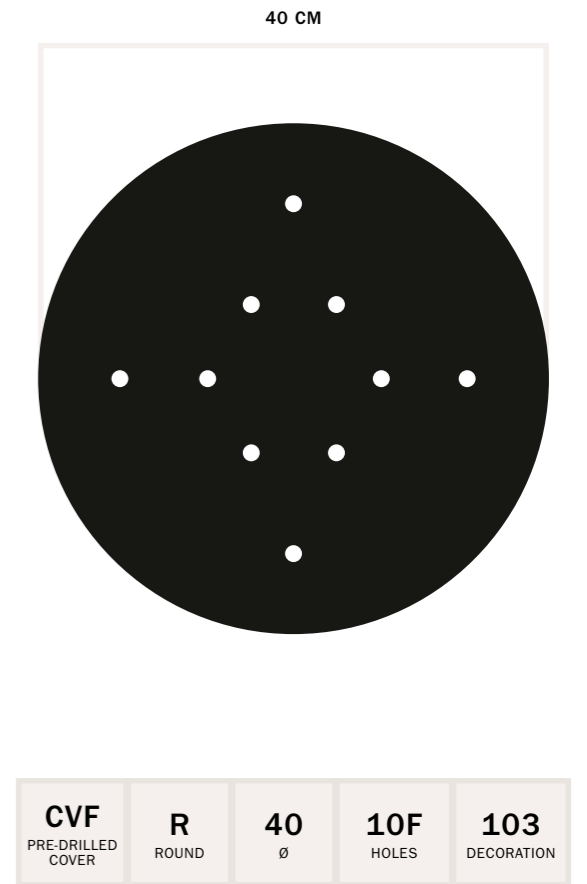
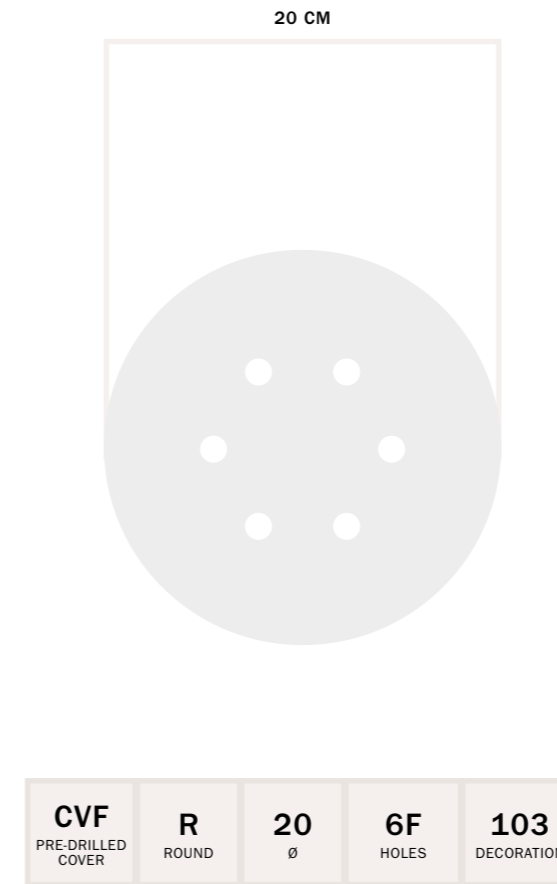

DIBOND® ROSE-ONE 5 HOLES FINISHES

Finish	Code
Matt White	CVFR206F102
Matt Black	CVFR206F103
Anthracite	CVFR206F111
Satin Steel	CVFR206F109
Marble Carrara	CVFR206F105
Concrete	CVFR206F106
Mirror	CVFR206F112
Petrol	CVFR206F115
Soft blue	CVFR206F114
Soft green	CVFR206F116
Mustard yellow	CVFR206F113
Satin Brass	CVFR206F107
Satin Copper	CVFR206F108
Wood	CVFR206F110

DIBOND® ROSE-ONE 9 HOLES FINISHES

Finish	Code
Matt White	CVFR4010F102
Matt Black	CVFR4010F103
Marble Marquina	CVFR4010F104
Satin Steel	CVFR4010F109
Anthracite	CVFR4010F111
Concrete	CVFR4010F106
Marble Carrara	CVFR4010F105
Mirror	CVFR4010F112
Petrol	CVFR4010F115
Soft blue	CVFR4010F114
Soft green	CVFR4010F116
Mustard yellow	CVFR4010F113
Satin Brass	CVFR4010F107
Satin Copper	CVFR4010F108
Wood	CVFR4010F110

Square small - 200mm

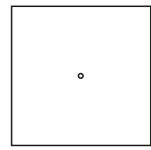

CVF Q 20 1F

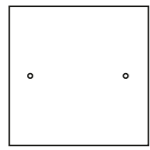

CVF Q 20 2F

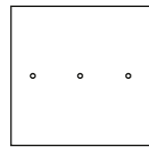

CVF Q 20 3LF

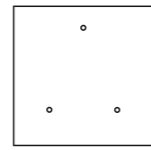

CVF Q 20 3TF

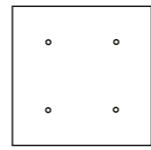

CVF Q 20 4F

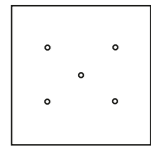

CVF Q 20 5F

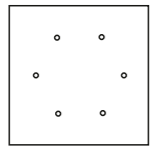

CVF Q 20 6F

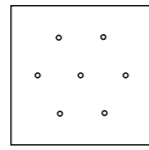

CVF Q 20 7F

Square large - 400mm

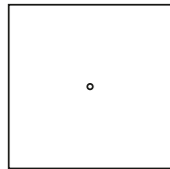

CVF Q 40 1F

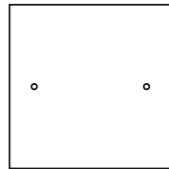

CVF Q 40 2F

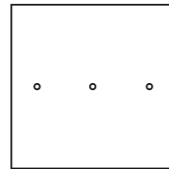

CVF Q 40 3LF

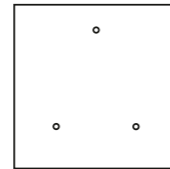

CVF Q 40 3TF

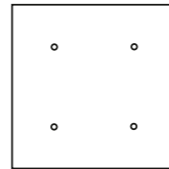

CVF Q 40 4F

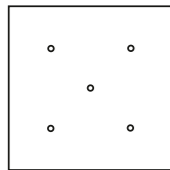

CVF Q 40 5PF

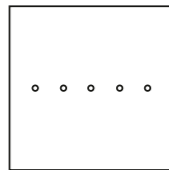

CVF Q 40 5LF

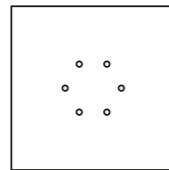

CVF Q 40 6F

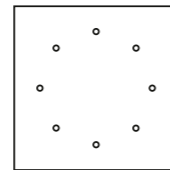

CVF Q 40 8F

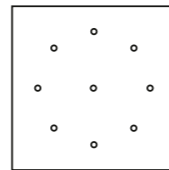

CVF Q 40 9EF

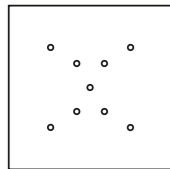

CVF Q 40 9XF

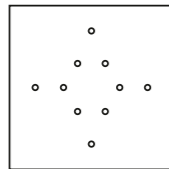

CVF Q 40 10F

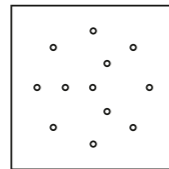

CVF Q 40 12F

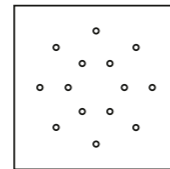

CVF Q 40 14F

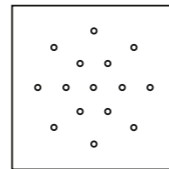

CVF Q 40 15F

How to compose the product code

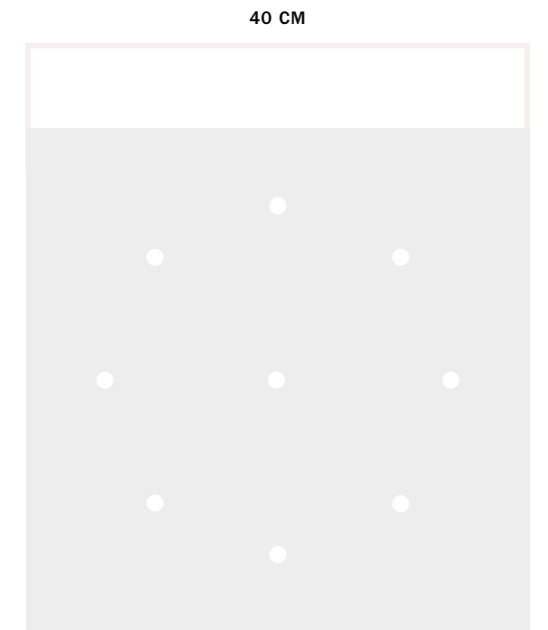
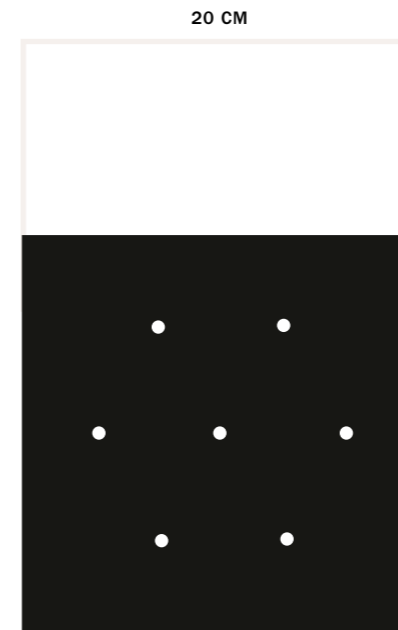

CVF PRE-DRILLED COVER	R ROUND	20 Ø	7F HOLES	103 DECORATION
------------------------------------	-------------------	----------------	--------------------	--------------------------

CVF PRE-DRILLED COVER	R ROUND	40 Ø	9F HOLES	103 DECORATION
------------------------------------	-------------------	----------------	--------------------	--------------------------

DIBOND® ROSE-ONE 7 HOLES FINISHES

Finish	Code
Matt White	CVFQ207F102
Matt Black	CVFQ207F103
Anthracite	CVFQ207F111
Satin Steel	CVFQ207F109
Concrete	CVFQ207F106
Mirror	CVFQ207F112
Petrol	CVFQ207F115
Soft blue	CVFQ207F114
Soft green	CVFQ207F116
Mustard yellow	CVFQ207F113
Satin Brass	CVFQ207F107
Satin Copper	CVFQ207F108
Wood	CVFQ207F110

DIBOND® ROSE-ONE 9 HOLES FINISHES

Finish	Code
Matt White	CVFQ409EF102
Matt Black	CVFQ409EF103
Anthracite	CVFQ409EF111
Satin Steel	CVFQ409EF109
Concrete	CVFQ409EF106
Mirror	CVFQ409EF112
Petrol	CVFQ409EF115
Soft blue	CVFQ409EF114
Soft green	CVFQ409EF116
Mustard yellow	CVFQ409EF113
Satin Brass	CVFQ409EF107
Satin Copper	CVFQ409EF108
Wood	CVFQ409EF110

Rectangular xxl 675 x 225mm

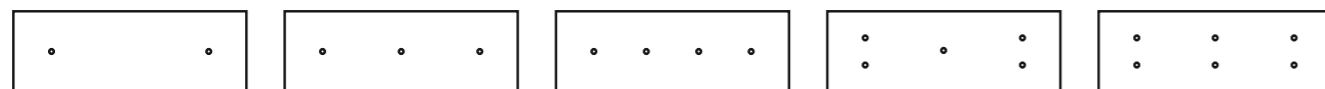

CVF RE 2F

CVF RE 3F

CVF RE 4F

CVF RE 5F

CVF RE 6F

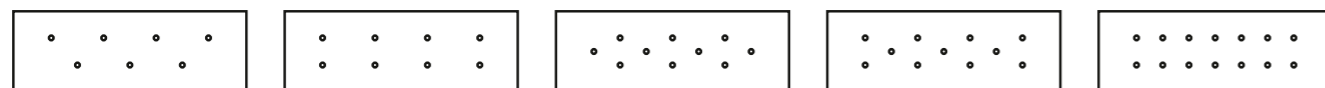

CVF RE 7F

CVF RE 8F

CVF RE 10F

CVF RE 11F

CVF RE 14F

How to compose the product code

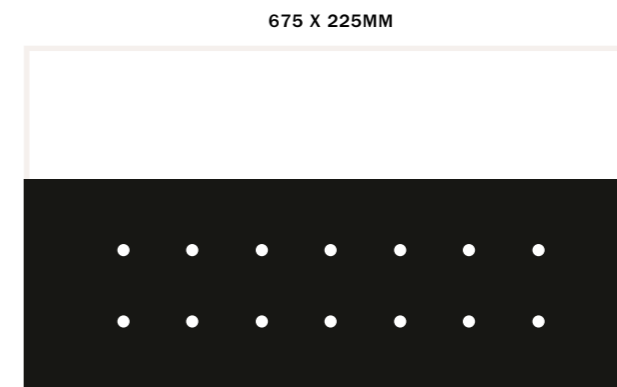

CVF PRE-DRILLED COVER	RE L	14F HOLES	103 DECORATION
------------------------------------	----------------	---------------------	--------------------------

DIBOND® ROSE-ONE 14 HOLES FINISHES

Finish	Code
● Matt White	CVFRE2F102
● Matt Black	CVFRE2F103
● Satin Steel	CVFRE2F109
● Satin Brass	CVFRE2F107
● Satin Copper	CVFRE2F108



1.1 Undrilled covers

The Rose-One undrilled come in three different shapes: square, round and rectangular. And the squared and round versions are available in two different dimensions, 200 and 400mm. Covers come in different designs and colors and are made in aluminum or dibond. Covers can be drilled following different kind of punching schemes: to drill the covers use our template.

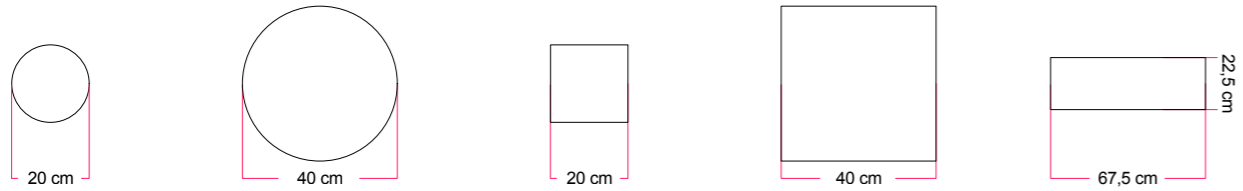

MATTE WHITE		MATTE BLACK	
ROUND 20	CVSR40102	ROUND 20	CVSR40103
ROUND 40	CVSR40102	ROUND 40	CVSR40103
SQUARE 20	CVSQ40102	SQUARE 20	CVSQ40103
SQUARE 40	CVSQ40102	SQUARE 40	CVSQ40103
RECTANGULAR	CVRE40102	RECTANGULAR	CVRE40103

MUSTARD YELLOW	
ROUND 20	CVSR40113
ROUND 40	CVSR40113
SQUARE 20	CVSQ40113
SQUARE 40	CVSQ40113

SUGAR BLUE	
ROUND 20	CVSR40114
ROUND 40	CVSR40114
SQUARE 20	CVSQ40114
SQUARE 40	CVSQ40114

PETROL	
ROUND 20	CVSR40115
ROUND 40	CVSR40115
SQUARE 20	CVSQ40115
SQUARE 40	CVSQ40115

SOFT GREEN	
ROUND 20	CVSR40106
ROUND 40	CVSR40106
SQUARE 20	CVSQ40106
SQUARE 40	CVSQ40106

ANTRACITE	
ROUND 20	CVSR40115
ROUND 40	CVSR40115
SQUARE 20	CVSQ40115
SQUARE 40	CVSQ40115

BRUSHED BRONZE	
ROUND 20	CVSR40107
ROUND 40	CVSR40107
SQUARE 20	CVSQ40107
SQUARE 40	CVSQ40107
RECTANGULAR	CVRE40107

BRUSHED COPPER	
ROUND 20	CVSR40108
ROUND 40	CVSR40108
SQUARE 20	CVSQ40108
SQUARE 40	CVSQ40108
RECTANGULAR	CVRE40108

BRUSHED TITANIUM	
ROUND 20	CVSR40109
ROUND 40	CVSR40109
SQUARE 20	CVSQ40109
SQUARE 40	CVSQ40109
RECTANGULAR	CVRE40109

MIRROR	
ROUND 20	CVSR40112
ROUND 40	CVSR40112
SQUARE 20	CVSQ40112
SQUARE 40	CVSQ40112

CONCRETE	
ROUND 20	CVSR40106
ROUND 40	CVSR40106
SQUARE 20	CVSQ40106
SQUARE 40	CVSQ40106

WOOD	
ROUND 20	CVSR40110
ROUND 40	CVSR40110
SQUARE 20	CVSQ40110
SQUARE 40	CVSQ40110

2. Base metal ceiling rose

The Rose-One system bases are available in black and white and in 3 versions, each suitable for the different shapes and sizes of Rose-One covers.

KRM127F4LVBO

Holes: **7+4**
Dimension: **120mm** SPØSTALUCE

KRM3015F4LVBO

Holes: **15+4**
Dimension: **300mm** SPØSTALUCE

KROVBORE

Holes: **21+6**
Dimension: **520x120mm** SPØSTALUCE

KRM127F4LVN

Holes: **7+4**
Dimension: **120mm** SPØSTALUCE

KRM3015F4LVN

Holes: **15+4**
Dimension: **300mm** SPØSTALUCE

KROVNRE

Holes: **21+6**
Dimension: **520x120mm** SPØSTALUCE

3. Cable clamps

The flat shape and transparent color plastic cable clamps designed for Rose-One system allow covers clearly visible.

PC100SER04

Sold in packs of 100

Wooden Templates to drill the covers yourself

These wooden templates allow you to drill any round, square or rectangular cover for the Rose-One in your store using a standard drill. The holes are numbered to facilitate drilling; if you prefer, you can use our guide to replicate the most classic hole patterns.

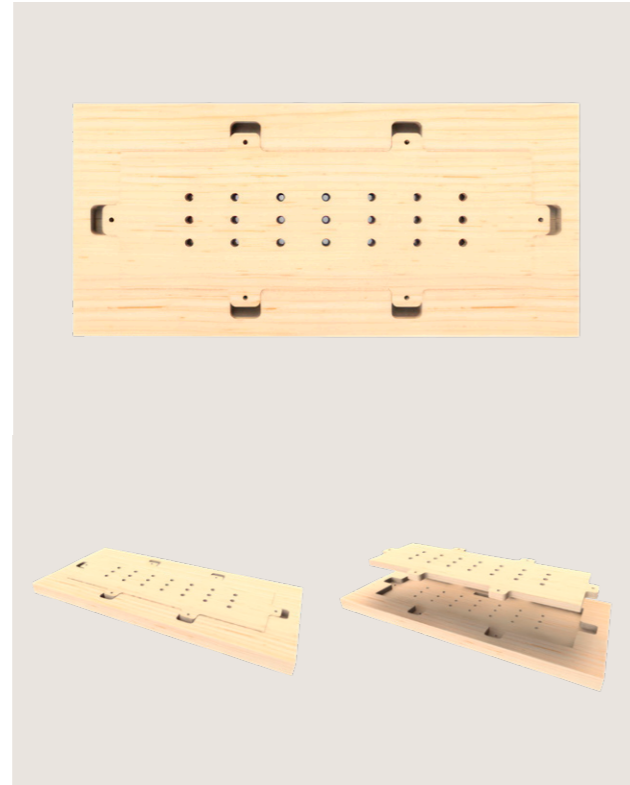

KDIMA-ROSE-ONE

You can drill the round and squared covers with the square template

KDIMA-ROSE-ONE

The rectangular covers has it's own template

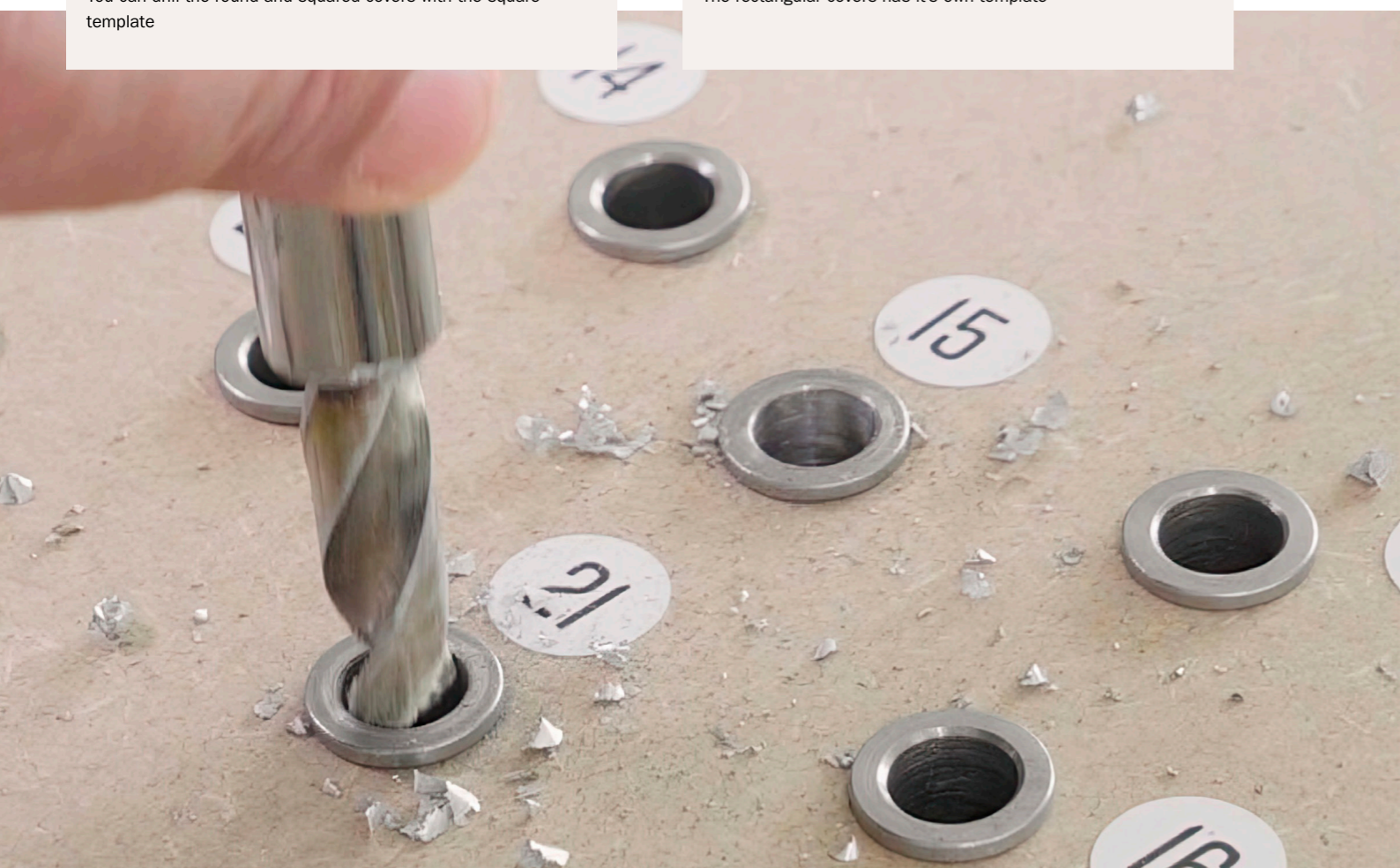



LAMPSHADES

If you are looking for a lampshade to complement your hanging, table or ceiling lamp, you will find solutions in different materials and sizes to suit the many interior design needs.

Handmade ceramic lampshades perfect for kitchens and dining tables, metal spotlight to create contemporary atmospheres, classic shades for table and wall lamps, funny wooden lampshade in limited editions: we have a solution for many tastes and interior design needs.



METAL LAMPSHADES

Discover our classic and timeless metal lampshades. You can find them in classic colors (white, black, or green) or in vibrant pastel shades.



Harbour lampshade

Material: **Polished Metal** CE UK CA

Fitting: **E27**

Weight: **1.4 kg**

Ferrule: **Included**



190 mm
390 mm

Finish	Code	Suitable for E26 socket	
White	KPAM09VBL	Green	KPAM09VVL
Black	KPAM09VNL	Soft Green	KPAM09VE
Petrol	KPAM09PE	Mustard yellow	KPAM09MU
Soft Blue	KPAM09SB		



NEW

Metal cage for Harbour lampshade

Material: **Polished Metal** CE UK CA



95 mm
400 mm

Finish	Code
White	GABBIA-L-VBO
Black	GABBIA-L-VN



Brodway lampshade

Material: **Polished Metal** CE UK CA

Fitting: **E27**

Weight: **1.5 kg**

Max bulb mmØ: **95 mm**



250 mm
300 mm

Finish	Code
White	PAM20VBL
Black	PAM20VNL



Bistrot lampshade

Material: **Polished Metal** CE UK CA

Fitting: **E27**

Weight: **1 kg**

Ferrule: **Included**



150 mm
300 mm

Finish	Code	Suitable for E26 socket	
White	KPAM10VBL	Green	KPAM10VVL
Black	KPAM10VNL		



Swing enamelled lampshade

Material: **Enamelled metal** CE UK CA

Fitting: **E27**

Weight: **0.6 kg**



60 mm
300 mm

Finish	Code	Suitable for E26 socket	
Black	PAM13VNO	White - Copper	PAM13VRL
Petrol	PAM13PE	White - Black	PAM13VNL
Soft green	PAM13VE	White - Br. Titanium	PAM13TIS
Soft blue	PAM13SB	White - Br. Copper	PAM13RAS
Mustard Yellow	PAM13MU	White - Br. Bronze	PAM13OTS



NEW

Metal cage for Bistrot lampshade

Material: **Polished Metal** CE UK CA



85 mm
310 mm

Finish	Code
White	GABBIA-S-VBO
Black	GABBIA-S-VN

METAL BULB CAGE LAMPSHADES

Our lampshades laid bare! Choose naked lampshades for a surprising scenic effect to create modern pendant lamps with one or more pendant and complete your light with a design bulb in plain sight.

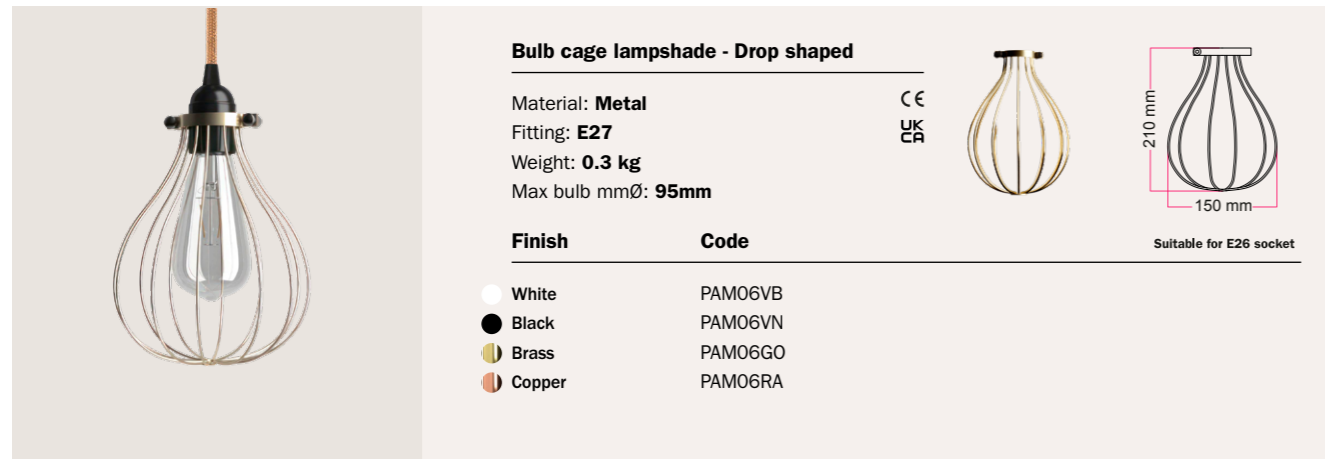

Bulb cage lampshade - Drop shaped

Material: **Metal** CE
UK
CA
 Fitting: **E27**
 Weight: **0.3 kg**
 Max bulb mmØ: **95mm**

Finish	Code
● White	PAM06VB
● Black	PAM06VN
● Brass	PAM06GO
● Copper	PAM06RA

Suitable for E26 socket



Bulb cage lampshade - Bottle shaped

Material: **Metal** CE
UK
CA
 Fitting: **E27**
 Weight: **0.4 kg**
 Max bulb mmØ: **100mm**

Finish	Code
● Black	PAM04VN

Suitable for E26 socket



Bulb cage lampshade - Bottle shaped

Material: **Metal** CE
UK
CA
 Fitting: **E27**
 Weight: **0.3 kg**
 Max bulb mmØ: **90mm**

Finish	Code
● Black	PAM03VN

Suitable for E26 socket





Bulb cage lampshade - Ghostbell

Cage: **Metal** CE
UK
CA
 Fitting: **E27**
 Weight: **0.3 kg**
 Max bulb mmØ: **64mm**

Finish	Code
● White	KPAM24VBOSVBO
● Black	KPAM24VNSVN
● Black - Br. titanium	KPAM24VNSRA
● Black - Br. bronze	KPAM24VNSGO
● Black - Br. copper	KPAM24VNSCR

UL Listed E26 socket is also available

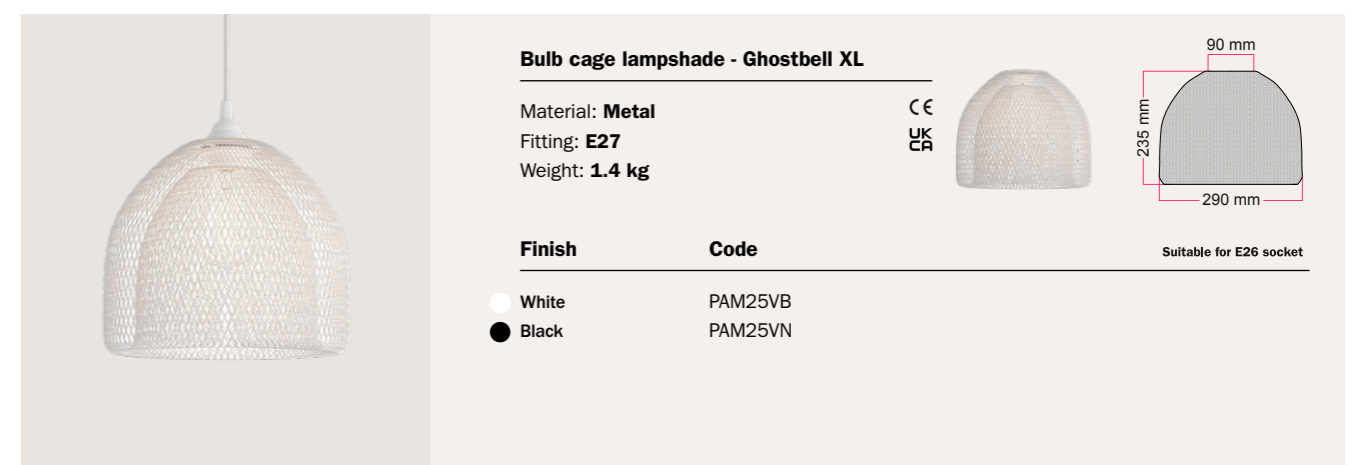
LAMPHOLDER INCLUDED



Bulb cage lampshade - Ghostbell XL

Material: **Metal** CE
UK
CA
 Fitting: **E27**
 Weight: **1.4 kg**

Finish	Code
● White	PAM25VB
● Black	PAM25VN

Suitable for E26 socket

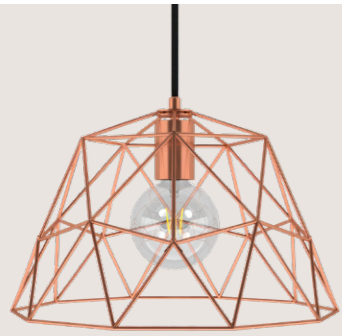

Bulb cage lampshade - Dome XL

Material: **Metal**
 Fitting: **E27**
 Weight: **1.4 kg**
 Max bulb mmØ: **125mm**



CE
UK

UL Listed E26 socket is also available

Finish	Code
White	KPAM23VBL
Black	KPAM23VNO
Copper	KPAM23VRL

LAMPHOLDER INCLUDED



Bulb cage lampshade - Diamond

Material: **Metal**
 Fitting: **E27**
 Weight: **0.2 kg**
 Max bulb mmØ: **125 mm**

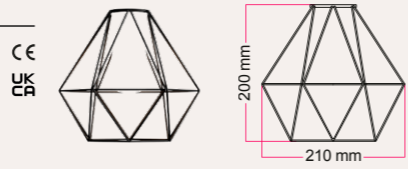

CE
UK

Suitable for E26 socket

Finish	Code	Finish	Code
White	PAM05VB	Turquoise	PAM05VT
Black	PAM05VN	Brass	PAM05GO
Red	PAM05VR	Copper	PAM05RA



Metal Duedi Apex lampshade

Material: **Metal**
 Fitting: **E27**
 Weight: **0.63 kg**
 Max bulb mmØ: **125mm**

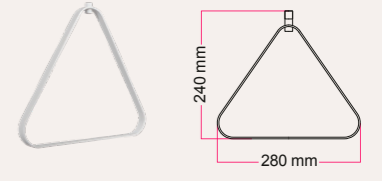

CE
UK

UL Listed E26 socket is also available

Finish	Code
White	KPAM19VBLBIA
Black	KPAM19VNONER

LAMPHOLDER INCLUDED



Metal Duedi Base lampshade

Material: **Metal**
 Fitting: **E27**
 Weight: **0.63 kg**
 Max bulb mmØ: **125mm**

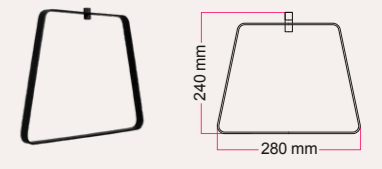

CE
UK

UL Listed E26 socket is also available

Finish	Code
White	KPAM18VBLBIA
Black	KPAM18VNONER

LAMPHOLDER INCLUDED



METAL ELLEPI

Ellepi is the metallic lampshade characterized by a minimal a captivating functional design, perfect for those who want to recreate a modern and Scandinavian style of furniture.



Ellepi dish oversize for suspension - 40cm

Material: **Painted iron**
 Fitting: **E27**
 Weight: **2.4 kg**

CE
UK
CA
MADE IN ITALY



Suitable for E26 socket

Finish	Code
White	DMBIA
Black	DMNER
Corten effect	DMCOR
Copper	DMRAM





Upsize Ellepi lampshade for outdoor - 40 cm

Material: **Dibond®**
 Fitting: **E27**
 Weight: **0.7 kg**

CE
UK
CA
MADE IN ITALY

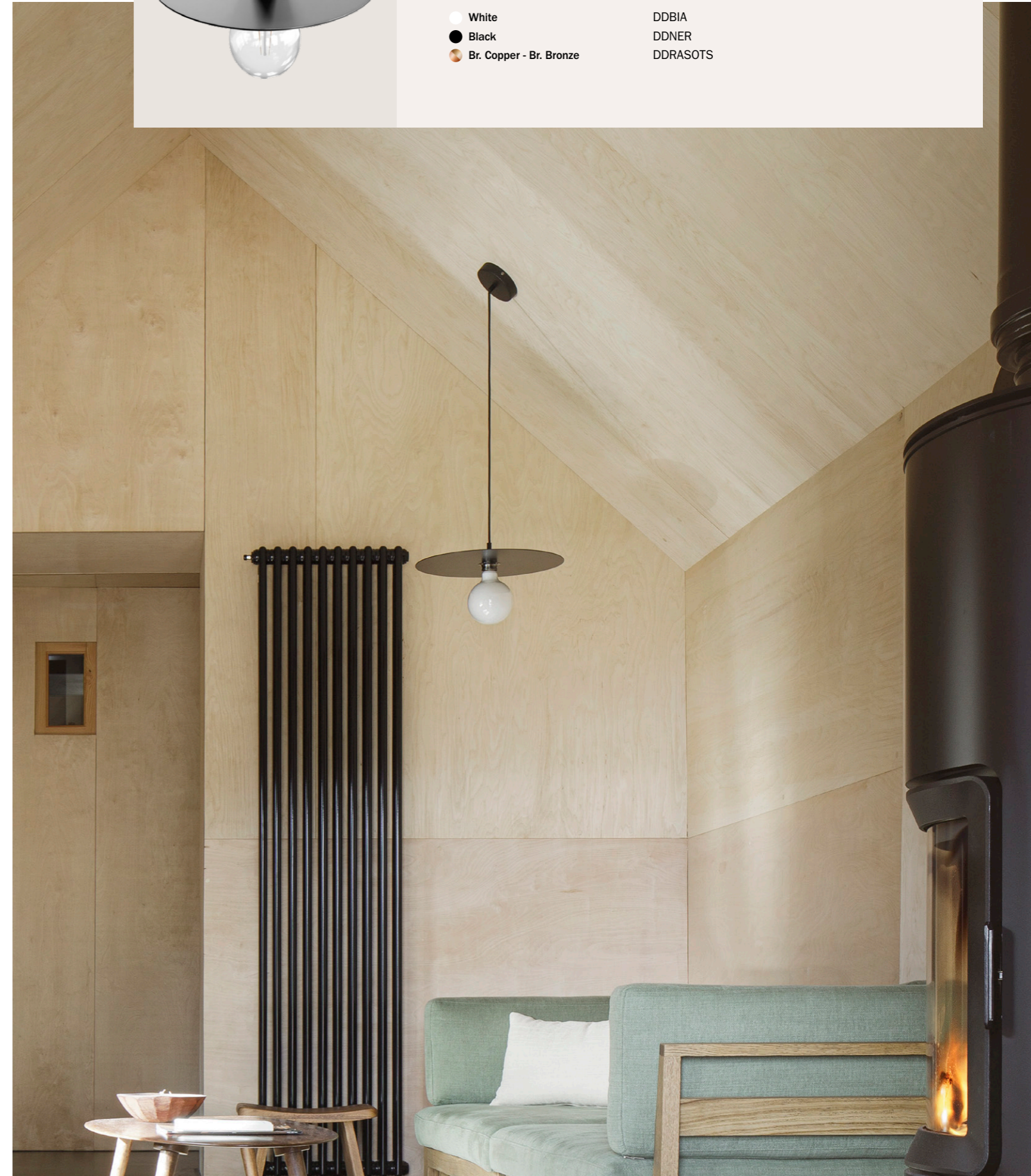

Finish	Code
White	DDBIA
Black	DDNER
Br. Copper - Br. Bronze	DDRASOTS



DIBOND® ELLEPI

The Ellepi mini flat lampshades are made from Dibond®, a light yet sturdy material able to withstand any weather. The colourful contrasts bring a breath of fresh air to any room or outdoor space.



Mini Ellepi lampshade 24 cm

Material: **Dibond®**
 Fitting: **E27**
 Weight: **0.2 kg**

CE
UK
CA
MADE IN ITALY



Suitable for E26 socket

Finish	Code
White	DD24BIA
Black	DD24NER
Glossy Blue - Matt Blue	DD24BLULBLUS
Glossy Red - Matt Red	DD24ROSLROSS
Light Green - Lemon Yellow	DD24VERGIA



MAIOLICA

COLLECTION

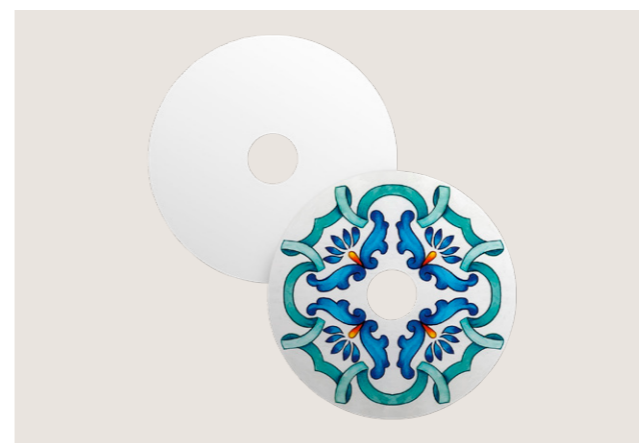

Mini Ellepì Maioliche lampshade - 24 cm

Material: **Dibond®** C €
 Fitting: **E27** UK
 Weight: **0.2 kg** CA
 Suitable for E26 socket
 MADE IN ITALY

Finish	Code
✦ Majolica Blue	DD24MA01



Mini Ellepì Maioliche lampshade - 24 cm

Material: **Dibond®** C €
 Fitting: **E27** UK
 Weight: **0.2 kg** CA
 Suitable for E26 socket
 MADE IN ITALY

Finish	Code
✦ Majolica Yellow - Green	DD24MA02



Mini Ellepì Maioliche lampshade - 24 cm

Material: **Dibond®** C €
 Fitting: **E27** UK
 Weight: **0.2 kg** CA
 Suitable for E26 socket
 MADE IN ITALY

Finish	Code
✦ Majolica Red - Green	DD24MA03

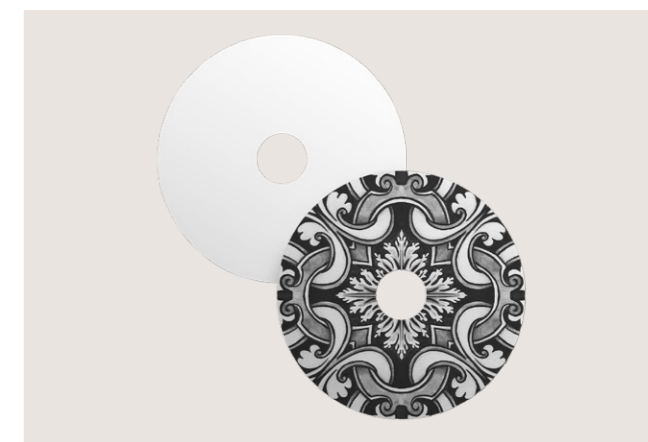

Mini Ellepì Maioliche lampshade - 24 cm

Material: **Dibond®** C €
 Fitting: **E27** UK
 Weight: **0.2 kg** CA
 Suitable for E26 socket
 MADE IN ITALY

Finish	Code
✦ Majolica White - Black	DD24MA04

MAIOLICA COLLECTION

The vibrant patterns of Majolica tiles have made them an iconic symbol of Mediterranean style. They inspired us to create four unique prints for our mini Ellepì flat lampshades, to decorate any outdoor or indoor space with dazzling colour contrasts. Ride the Mediterranean wave!

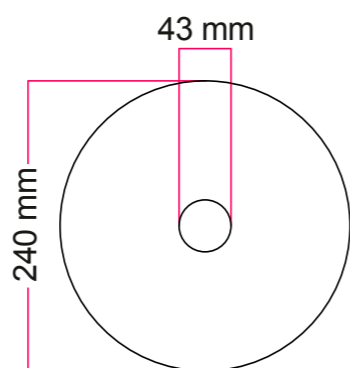

UFO

UFO - Unconventional Flying Object - is the wooden lampshade characterized by a minimal a captivating functional design, perfect for those who want to recreate a modern and Scandinavian style of furniture. The Line in painted wood is distinguished by a palette of pastel colours, perfect not only for the children's room or bedroom, but also to blend into modern living rooms or kitchens.



UFO color varnished lampshade

Material: **Wood**
 Fitting: **E27**
 Weight: **0.34 kg**

CE
UK
CA
MADE IN ITALY



Suitable for E26 socket

Finish	Code
Grey	LPW7039
Pink	LPW3015
Red	LPW3020
Yellow	LPW1015
Green	LPW6019
Blue	LPW5020

UFO lampshade

Material: **Poplar wood**
 Fitting: **E27**
 Weight: **0.34 kg**

CE
UK
CA
MADE IN ITALY

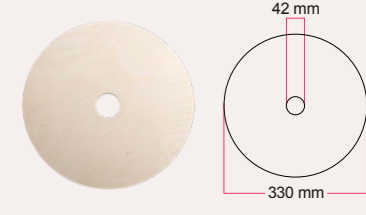

Suitable for E26 socket

Finish	Code
Neutral	LPWUFONAT

UFO UNCONVENTIONAL FLYING OBJECT

We selected 7 famous & promising emerging artists, we chose two of their most representative artworks and we lit them up: this is how the UFO collection - Unconventional Flying Objects was born. 7 double-faced wooden disks, processed and printed in Italy, ready to become a wall or a suspension lamp. Well, actually two: both sides of the disk are illustrated with different designs!
Men and women, cactus and pineapples, mandala and azulejos, ice cream and cupcakes, and not to forget fish, dogs and flamingoes: A surprising variety of subjects and colours that create playful, romantic or surreal atmospheres.

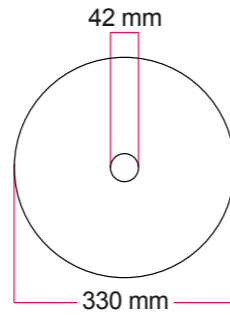

UFO - Special Edition Italian Illustrators

Material: **Poplar Wood** C €
UK
CA
Fitting: **E27**
Weight: **0.34 kg** Suitable for E26 socket
MADE IN ITALY

Finish	Code
Carolina Zuniga	LPWUF014



UFO - Special Edition Italian Illustrators

Material: **Poplar Wood** C €
UK
CA
Fitting: **E27**
Weight: **0.34 kg** Suitable for E26 socket
MADE IN ITALY

Finish	Code
Chiara Fucà	LPWUF006



UFO - Special Edition Italian Illustrators

Material: **Poplar Wood** C €
UK
CA
Fitting: **E27**
Weight: **0.34 kg** Suitable for E26 socket
MADE IN ITALY

Finish	Code
Fernando Cabelo	LPWUF004

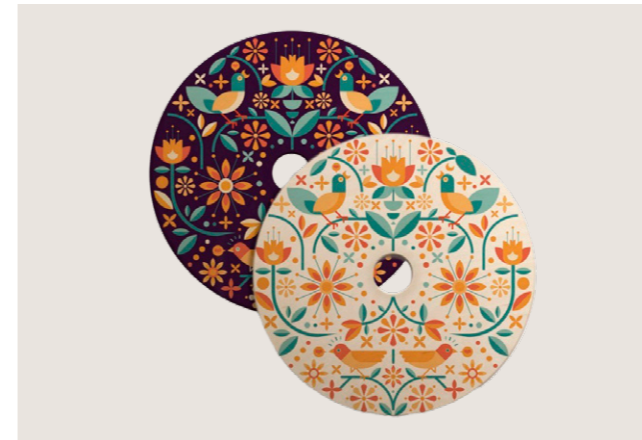

UFO - Special Edition Italian Illustrators

Material: **Poplar Wood** C €
UK
CA
Fitting: **E27**
Weight: **0.34 kg** Suitable for E26 socket
MADE IN ITALY

Finish	Code
Francesco Poroli	LPWUF008



UFO - Special Edition Italian Illustrators

Material: **Poplar Wood** C €
UK
CA
Fitting: **E27**
Weight: **0.34 kg** Suitable for E26 socket
MADE IN ITALY

Finish	Code
Davide Bonazzi	LPWUF003

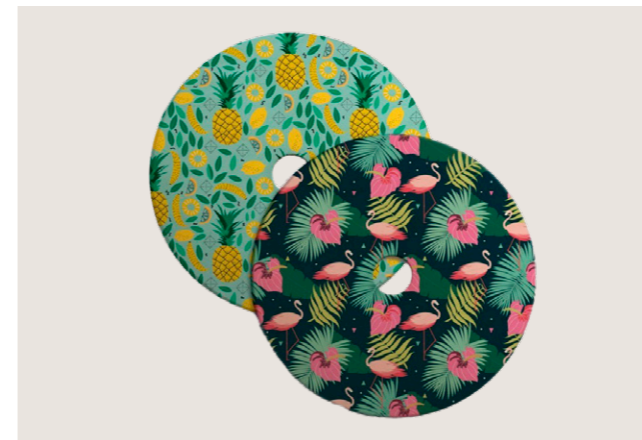

UFO - Special Edition Italian Illustrators

Material: **Poplar Wood** C €
UK
CA
Fitting: **E27**
Weight: **0.34 kg** Suitable for E26 socket
MADE IN ITALY

Finish	Code
Annachiara Zaminato	LPWUF012



UFO - Special Edition Italian Illustrators

Material: **Poplar Wood** C €
UK
CA
Fitting: **E27**
Weight: **0.34 kg** Suitable for E26 socket
MADE IN ITALY

Finish	Code
ODD	LPWUF005

CERAMIC SHADES

Near Florence, there is a place of excellence, where the ancient pottery tradition meets the inventiveness of Creative Cables's designers to conjure up lamp holders, ceiling roses and lampshades of the highest quality. And the expert hands of the team of painters decorate every single component to give you unique 100% made-in-italy products.



Mini Bell XS lampshade for suspension

Material: **Painted ceramic** CE
 Fitting: **E27** UK
 Weight: **1 kg** CA
 Max bulb mmØ: **95 mm**

MADE IN ITALY



Finish	Code
● Glossy White	EKMCBIBI
● Blackboard	EKMCLABI
● Ceramic - White	EKMCCEBI
● Corten - White	EKMCRUBI
● Copper Green - White	EKMCRABI

Suitable for E26 socket



Bell M lampshade for suspension

Material: **Painted ceramic** CE
 Fitting: **E27** UK
 Weight: **2 kg** CA

MADE IN ITALY



Finish	Code
● Glossy White	EKCTBIAN
● Blackboard - White	EKCTLABI
● Ceramic - White	EKCTCEBI
● Corten - White	EKCTRUBI

Suitable for E26 socket



Bell XL lampshade for suspension

Material: **Painted ceramic** CE
 Fitting: **E27** UK
 Weight: **3 kg** CA

MADE IN ITALY



Finish	Code
● Glossy White	EKCABIAN
● Blackboard - White	EKCALABI
● Ceramic - White	EKCACEBI
● Corten - White	EKCARUBI

Suitable for E26 socket





Ceramic Dish lampshade for suspension

Material: **Glazed ceramic**
 Fitting: **E27**
 Weight: **1 kg**

CE
UK
CA
MADE IN ITALY



Finish **Code** Suitable for E26 socket

● Glossy White	EKPCBIAN	
● Cement - White	EKPCCEBI	
● Corten - White	EKPCRUBI	
● Black - Copper	EKPCNERA	



Industrial lampshade for suspension

Material: **Glazed ceramic**
 Fitting: **E27**
 Weight: **1 kg**

CE
UK
CA
MADE IN ITALY



Finish **Code** Suitable for E26 socket

● Glossy White	EKPSBIAN	
● Cement - White	EKPSCEBI	
● Corten - White	EKPSRUBI	
● Black - Copper	EKPSNERA	

Vase lampshade - Materia collection

Material: **Painted ceramic**
 Fitting: **E27**
 Weight: **0.45 kg**

CE
UK
CA
MADE IN ITALY

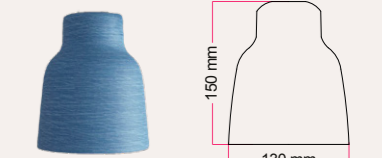

Finish **Code** Suitable for E26 socket

● Glossy White	EKBIBIAN	● Streaked Evergreen	EKBISTVRB
● Blackboard	EKBILABI	● Streaked Terracotta	EKBISTTC
● Ceramic	EKBICEBI	● Streaked Coral	EKBISTRSS
● Corten	EKBIRUBI	● Streaked Dove-Grey	EKBISTTRT
● Streaked Avion	EKBISTAVN		



Bottle lampshade - Materia collection

Material: **Painted ceramic**
 Fitting: **E27**
 Weight: **1 kg**

CE
UK
CA
MADE IN ITALY



Finish **Code** Suitable for E26 socket

● Glossy White	EKBOBIAN	● Streaked Evergreen	EKBOSTVRB
● Ceramic	EKBOCEBI	● Streaked Terracotta	EKBOSTTC
● Corten	EKBORUBI	● Streaked Coral	EKBOSTRSS
● Blackboard	EKBOLABI	● Streaked Dove-Grey	EKBOSTTRT
● Streaked Avion	EKBOSTAVN		



Cup lampshade - Materia collection

Material: **Painted ceramic**
 Fitting: **E27**
 Weight: **1 kg**

CE
MADE IN ITALY



Finish **Code** Suitable for E26 socket

● Glossy White	EKBIAN	● Streaked Terracotta	EKSTTC
● Blackboard	EKLABI	● Streaked Coral	EKSTRSS
● Ceramic	EKCEBI	● Streaked Dove-Grey	EKSTTRT
● Corten	EKRUBI		
● Streaked Avion	EKSTAVN		
● Streaked Evergreen	EKSTVRB		

CEMENT SHADES

Cement lampshades are not just a simple cover for the lamp holder like many others, but rather genuine decorative elements capable of imparting a distinct character to the environment in which they are placed. The inherent qualities of the material and the manufacturing process result in each lampshade having a slightly irregular surface, making it unique in its own right.



Prisma lampshade for suspension

Material: **Cement** CE
UK
CA

Fitting: **E27**

Weight: **2.4 kg**

Max bulb mmØ: **64 mm**

Finish	Code
● Light Ceramic	KPAC01CGL
● Dark Cement	KPAC01CGD

LAMPHOLDER INCLUDED

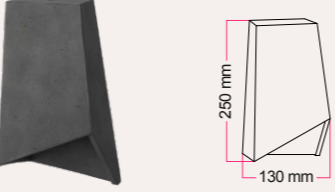

250 mm
130 mm



Cube lampshade for suspension

Material: **Cement** CE
UK
CA

Fitting: **E27**

Weight: **3.4 kg**

Max bulb mmØ: **95 mm**

Finish	Code
● Light Ceramic	KPAC03CGL
● Dark Cement	KPAC03CGD

LAMPHOLDER INCLUDED



220 mm
150 mm

UL Listed E26 socket is also available



Funnel Lampshade for suspension

Material: **Cement** CE
UK
CA

Fitting: **E27**

Weight: **3.5 kg**

Max bulb mmØ: **95 mm**

Finish	Code
● Light Ceramic	KPAC02CGL
● Dark Cement	KPAC02CGD

LAMPHOLDER INCLUDED



260 mm
200 mm



FABRIC SHADES

From the heart of Tuscany, our lampshades are made by hand but created by passion. A fusion of craftsmanship and modern technological innovation brings to life our entirely handsewn fabric lampshades. Ancient knowledge passed on from father to son, which today brightens up your spaces with the guarantee of the distinguishing Tuscan high-quality craftsmanship.



Athena lampshade for table lamp

Material: **Fabric Coating** CE
 Fitting: **E27** UK
 Weight: **0.25 kg** CA

MADE IN ITALY



150 mm
240 mm

Finish	Code
White	PARIME27415BIA
Black	PARIME27415NEOR
Natural Jute	PARIME27415JUT



Impero Fabric lampshade for table or wall lamp

Material: **Fabric Coating** CE
 Fitting: **E27** UK
 Weight: **0.16 kg** CA

MADE IN ITALY



130 mm
200 mm

Finish	Code	Suitable for E26 socket	
Light Jute	PARIME27JCGG	Canvas Anthracite	PARIME27TEAN
Natural Jute	PARIME27JNGN	Black Cinette	PARIME27CINEOR
Grey Jute	PARIME27JGGGS		



Cylindric Fabric lampshade

Material: **Fabric Coating** CE
 Fitting: **E27** UK
 Weight: **0.25 kg** CA

MADE IN ITALY



180 mm
150 mm

Finish	Code	Suitable for E26 socket	
Petrol Blue Cinette	PARCIE27CIPET	Glossy White Linon	PARCIE27LIBIA
Burgundy Canvas	PARCIE27TEBOR	Natural Raffia	PARCIE27RNGC
Lobster Cinette	PARCIE27CIARA	Brown Camelot	PARCIE27CAMAR
Black Canvas	PARCIE27TENER		



NEW

Impero Mini lampshade for table or wall lamp

Material: **Fabric Coating** CE
 Fitting: **E27** UK
 Weight: **0.14 kg** CA



140 mm
124 mm

Finish	Code	Suitable for E26 socket
Jute	PARIME27JCH	
Pleated shade cream	PARIME27PLICR	
White canvas	PARIME27TEBIA	
Grey canvas	PARIME27TEGRI	

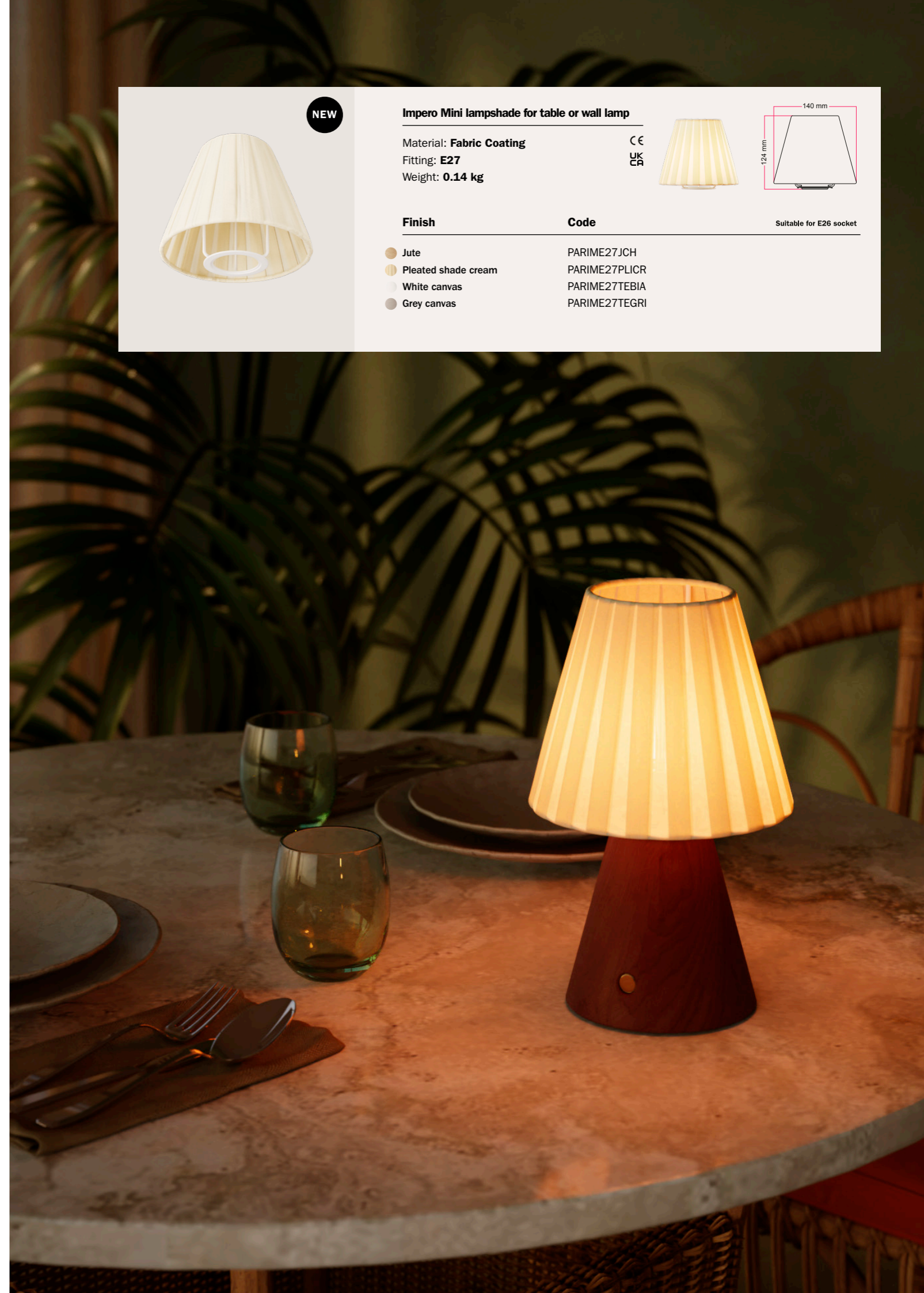

FIBRE LAMPSHADES

Dome

With the Dome lampshade, you can create lamps with a unique style, thanks to the wide variety of available colors and sizes. Each one is handmade and compatible with E27 lamp holders for lampshades. The package includes the lampshade, the mounting kit, and the instruction manual.

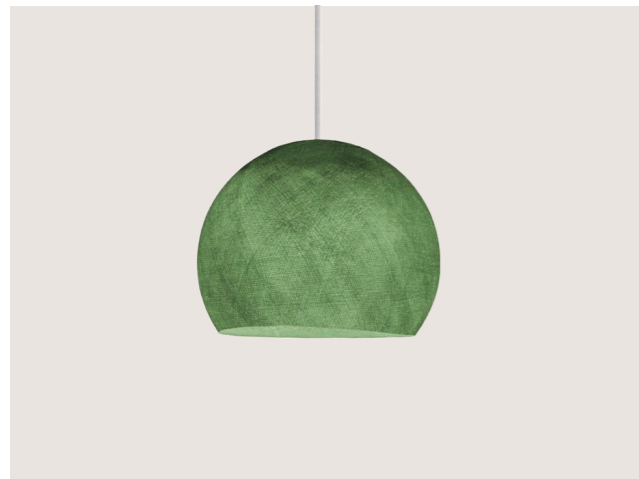
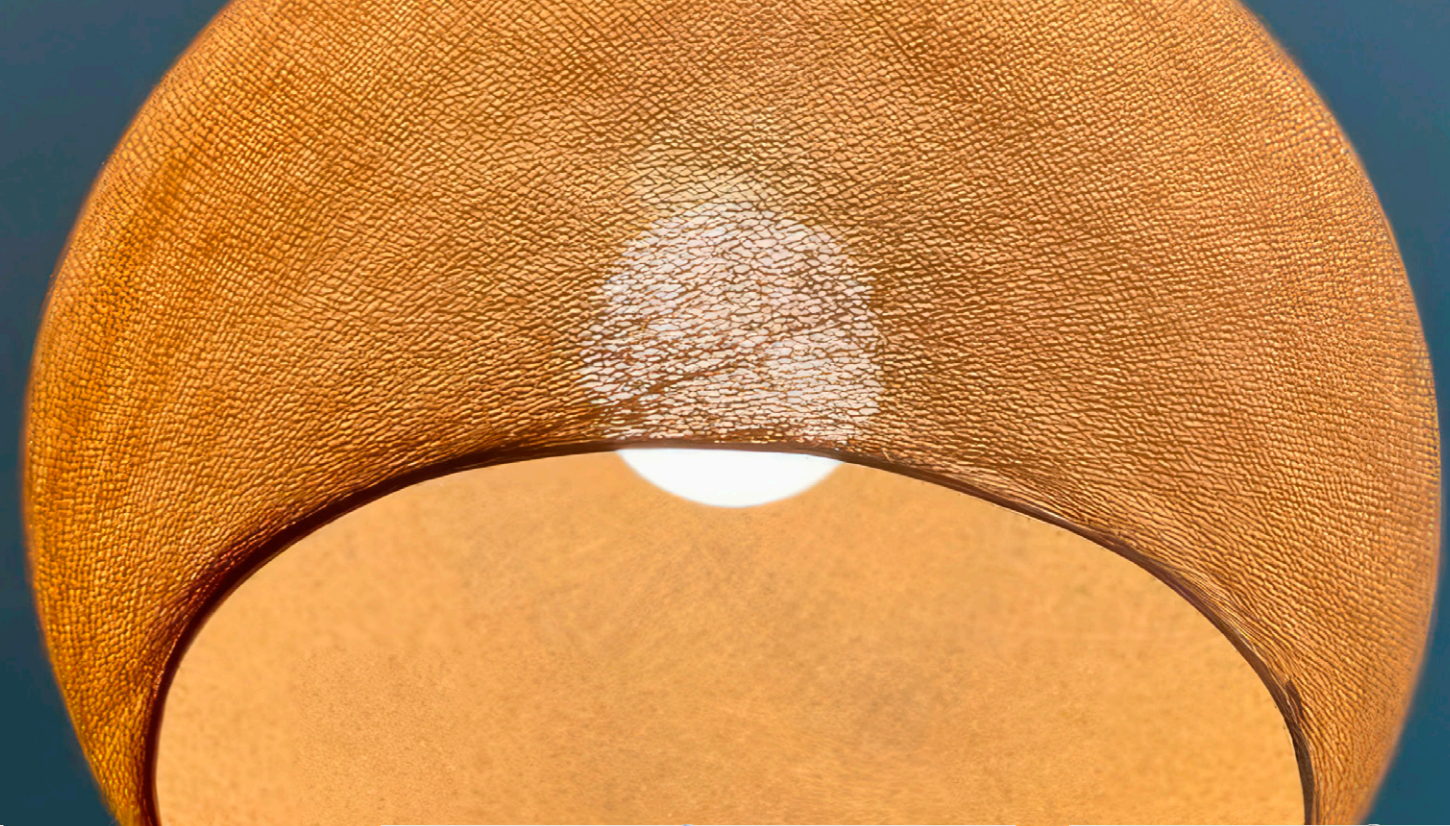

Dome Lampshade in fiber

Material: **Handworked Polyester** CE
UK
CA
Fitting: **E27**
Size: **XS - 250 Ø** Suitable for E26 socket

Finish	Code
White Polyester	PAT1XS-CP0953
Pearl Grey Polyester	PAT1XS-CP0948
Ecru Beige Polyester	PAT1XS-CP1612
Sand Polyester	PAT1XS-CP1613
Mustard Polyester	PAT1XS-CP1341
Petrol Blue Polyester	PAT1XS-CP0957
Olive Green Polyester	PAT1XS-CP3958
Milky Green Polyester	PAT1XS-CP3999

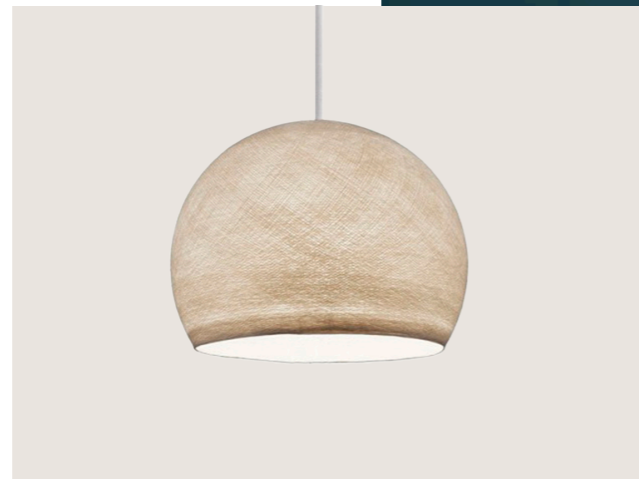
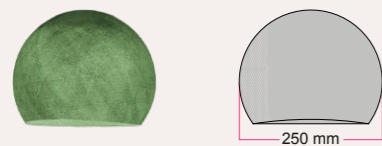

Dome Lampshade in fiber

Material: **Handworked Polyester** CE
UK
CA
Fitting: **E27**
Size: **S - 310 Ø** Suitable for E26 socket

Finish	Code
White Polyester	PAT1S-CP0907
Pearl Grey Polyester	PAT1S-CP0902
Ecru Beige Polyester	PAT1S-CP1624
Sand Polyester	PAT1S-CP1625
Mustard Polyester	PAT1S-CP1339
Petrol Blue Polyester	PAT1S-CP0911
Olive Green Polyester	PAT1S-CP3847
Milky Green Polyester	PAT1S-CP3906



Dome Lampshade in fiber

Material: **Handworked Polyester** CE
UK
CA
Fitting: **E27**
Size: **M - 360 Ø** Suitable for E26 socket

Finish	Code
White Polyester	PAT1M-CP0861
Pearl Grey Polyester	PAT1M-CP0856
Ecru Beige Polyester	PAT1M-CP1636
Sand Polyester	PAT1M-CP1637
Mustard Polyester	PAT1M-CP1337
Petrol Blue Polyester	PAT1M-CP0865
Olive Green Polyester	PAT1M-CP3836
Milky Green Polyester	PAT1M-CP3907

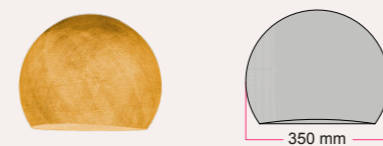

Dome Lampshade in fiber

Material: **Handworked Polyester** CE
UK
CA
Fitting: **E27**
Size: **L - 420 Ø** Suitable for E26 socket

Finish	Code
White Polyester	PAT1L-CP0814
Pearl Grey Polyester	PAT1L-CP0809
Ecru Beige Polyester	PAT1L-CP1648
Sand Polyester	PAT1L-CP1649
Mustard Polyester	PAT1L-CP1332
Petrol Blue Polyester	PAT1L-CP0818
Olive Green Polyester	PAT1L-CP3854
Milky Green Polyester	PAT1L-CP3977

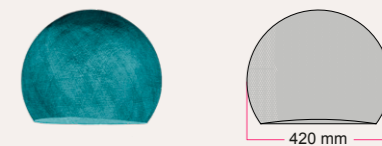

FIBRE LAMPSHADES

Sphere

Craft unique-style lamps with the Sphere lampshade, available in a wide range of colors and sizes. Each lampshade is handmade and designed to fit E27 lamp holders, and the package includes the lampshade, mounting kit, and an instruction manual.

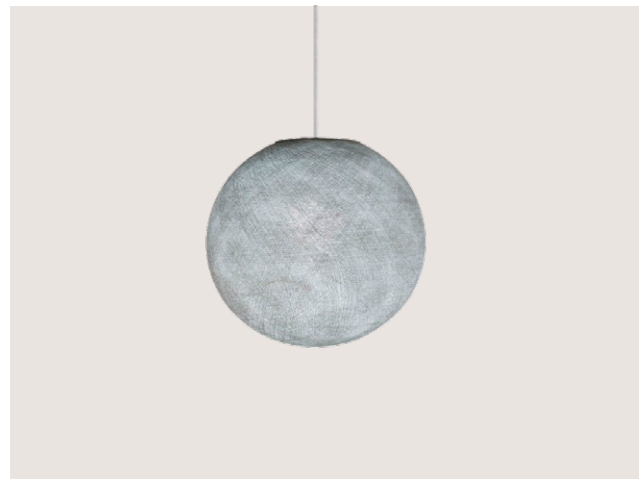

Sphere Lampshade in fiber

Material: **Handworked Polyester** CE
 Fitting: **E27** UK
 Size: **XS - 250 Ø** CA
Suitable for E26 socket

Finish	Code
White Polyester	PAT2XS-CP0210
Pearl Grey Polyester	PAT2XS-CP0205
Ecru Beige Polyester	PAT2XS-CP1553
Sand Polyester	PAT2XS-CP1554
Mustard Polyester	PAT2XS-CP1349
Petrol Blue Polyester	PAT2XS-CP0213
Olive Green Polyester	PAT2XS-CP3826
Milky Green Polyester	PAT2XS-CP4020

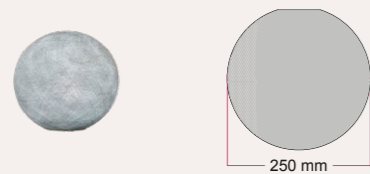

Sphere Lampshade in fiber

Material: **Handworked Polyester** CE
 Fitting: **E27** UK
 Size: **S - 310 Ø** CA
Suitable for E26 socket

Finish	Code
White Polyester	PAT2S-CP0171
Pearl Grey Polyester	PAT2S-CP0166
Ecru Beige Polyester	PAT2S-CP1576
Sand Polyester	PAT2S-CP1577
Mustard Polyester	PAT2S-CP1347
Petrol Blue Polyester	PAT2S-CP0174
Olive Green Polyester	PAT2S-CP3828
Milky Green Polyester	PAT2S-CP3920

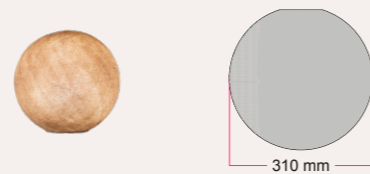

Sphere Lampshade in fiber

Material: **Handworked Polyester** CE
 Fitting: **E27** UK
 Size: **M - 360 Ø** CA
Suitable for E26 socket

Finish	Code
White Polyester	PAT2M-CP0128
Pearl Grey Polyester	PAT2M-CP0124
Ecru Beige Polyester	PAT2M-CP1588
Sand Polyester	PAT2M-CP1589
Mustard Polyester	PAT2M-CP1345
Petrol Blue Polyester	PAT2M-CP0131
Olive Green Polyester	PAT2M-CP3830
Milky Green Polyester	PAT2M-CP3921

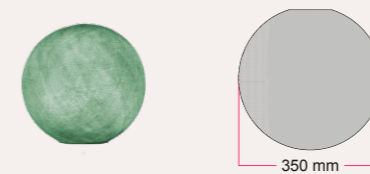

Sphere Lampshade in fiber

Material: **Handworked Polyester** CE
 Fitting: **E27** UK
 Size: **L - 420 mm** CA
Suitable for E26 socket

Finish	Code
White Polyester	PAT2L-CP0086
Pearl Grey Polyester	PAT2L-CP0081
Ecru Beige Polyester	PAT2L-CP1600
Sand Polyester	PAT2L-CP1601
Mustard Polyester	PAT2L-CP1343
Petrol Blue Polyester	PAT2L-CP0089
Olive Green Polyester	PAT2L-CP3832
Milky Green Polyester	PAT2L-CP3995

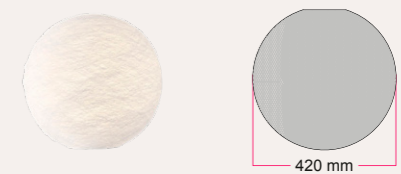

FIBRE LAMPSHADES

Sphere XL & XXL

Born from a collaboration between Creative Cables and French brand La Case de Cousin Paul, Sphere Light is a crafted lampshade created through a refined weaving technique, ensuring a light and delicate texture. Each lampshade is handmade, with unique weaving in every piece, striking a delicate balance between translucency and structure, adding charm and character to any room. You will receive the Sphere Light lampshade in a compact package, ready for easy assembly with the included instructions.



Handmade threaded Sphere Light lampshade

Material: **Handworked Polyester** CE
 Fitting: **E27** UK
 Size: **XL - 500 mm** Suitable for E26 socket

Finish	Code
● White Polyester	PAT2XL-CP4621
● Anthracite Grey Polyester	PAT2XL-CP4619

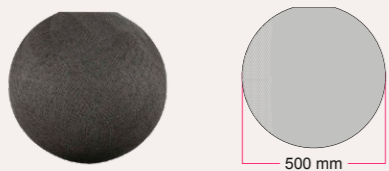

Handmade threaded Sphere Light lampshade

Material: **Handworked Polyester** CE
 Fitting: **E27** UK
 Size: **XXL - 670 mm** Suitable for E26 socket

Finish	Code
● White Polyester	PAT2XXL-CP4622
● Anthracite Grey Polyester	PAT2XXL-CP4620



CABLÒ

Here at Creative Cables we always strive for the best, both for our customers and our planet. Cablò is a perfect representation of that: a support made from recycled plastic that adapts to any suspension and lamp holder, turning a simple accessory into a floating piece of art.

Cablò

Design by Fabrizio Alessio



CABLOREC

Diameter: 10 cm



CABLONER

Diameter: 10 cm

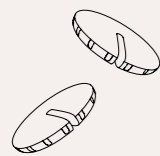

1.
Choose your Cablò and the cables you like.

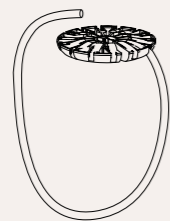

2.
Open and insert the cables in the slots.



3.
When satisfied with your design, close the Cablò.

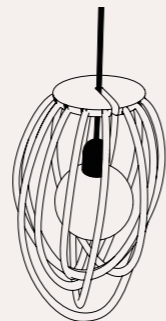

4.
Mount it on any suspension with the built-in clamp.

Suitable for E26 socket

CUSTOMIZE IT

Any original Creative Cables 2x and 3x fabric cable that is at least 50cm long can become a Cablò component. Pick out your kit, available in the black or multicolour version, and use it to create your fully customisable lamp. What's more, by using different combinations you will achieve many different shapes and weaves.



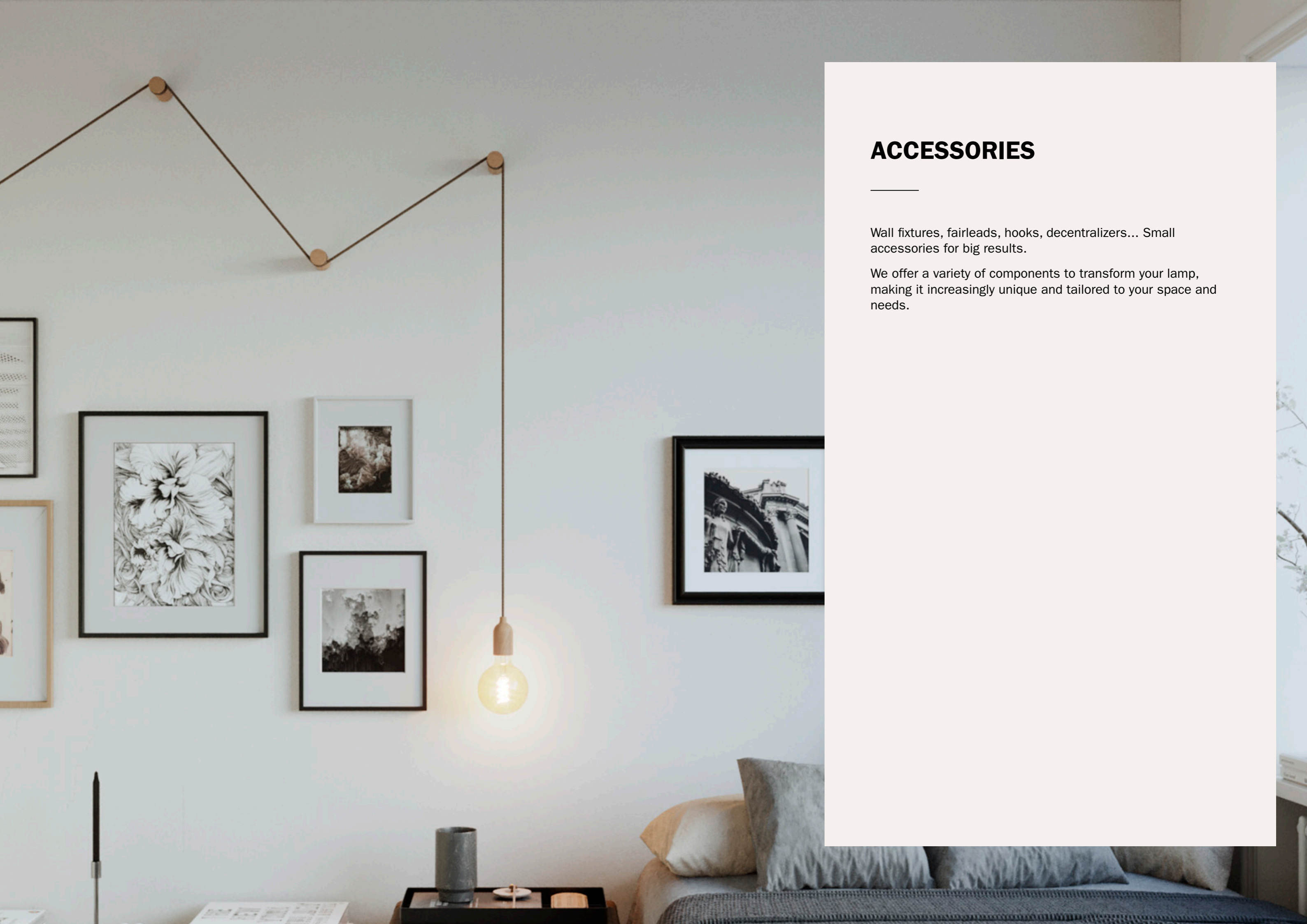

ACCESSORIES

Wall fixtures, fairleads, hooks, decentralizers... Small accessories for big results.

We offer a variety of components to transform your lamp, making it increasingly unique and tailored to your space and needs.

PINOCCHIO

Pinocchio is Creative Cables adjustable wall mount for pendant lamp: it is made in Italy out of 100% beechtree wood and it can be polished or painted as desired.

The cable doesn't go through any holes, it is wrapped around ridged wooden supports at each end: we strongly recommend you to use it with our lamps Snake, Snake for lampshades and SnakeBis. Pinocchio makes it possible to hang a lamp onto a wall, even with a lampshade with a 50cm maximum diameter and a 3,365 kg maximum weight.

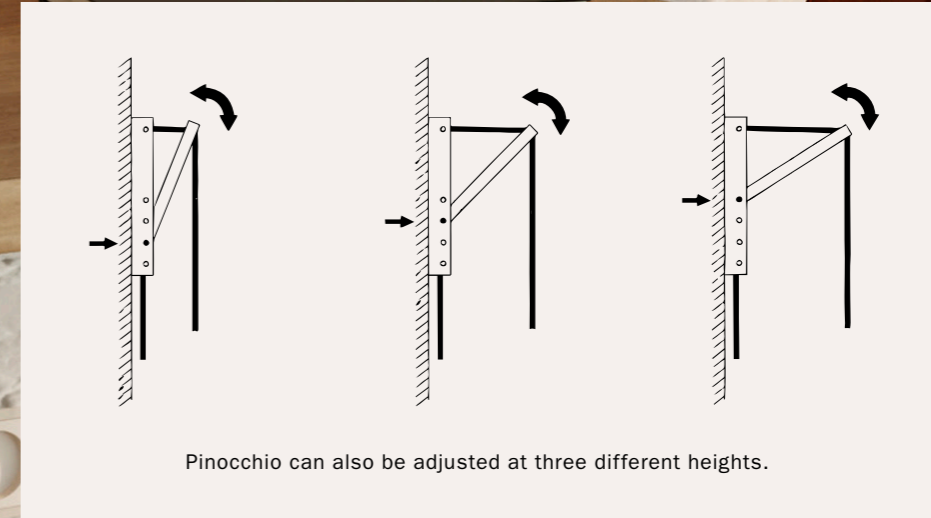
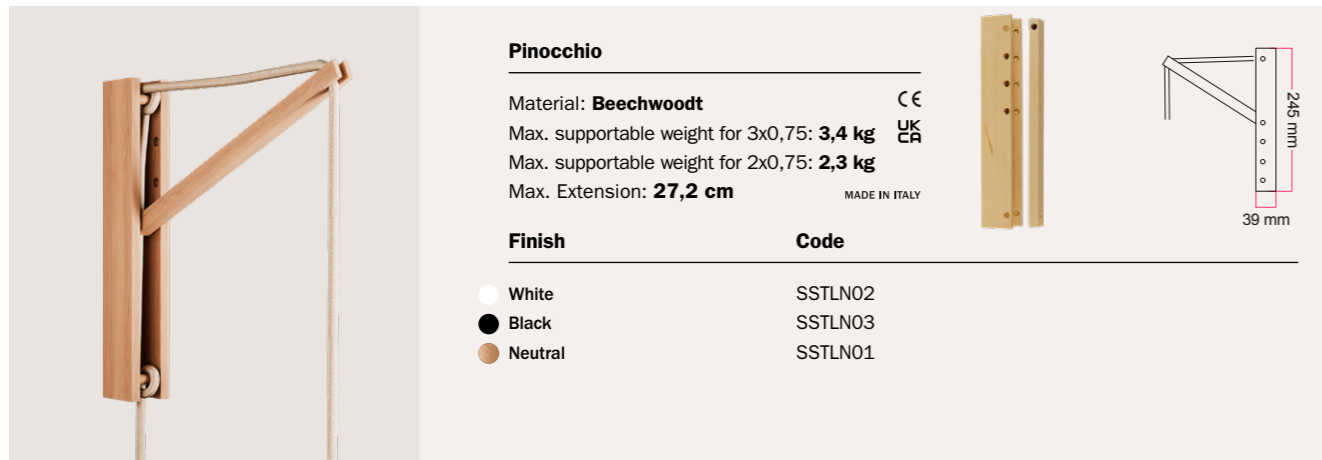

PINOCCHIO XL

Pinocchio XL is not a simple wall bracket! It is Creative Cables' solution to hang your lamp where you need it, allowing you to adjust the distance and the position of the light source from the wall. Thanks to the groove in the last rod, the cable remains locked in a safe position.

Made (in Italy) from untreated beechwood, it can be impregnated or painted with the colour you want. And if you wish to add a lampshade, you can complete your installation with the ceiling brackets included in the kit.



ZIGH-ZAGH

Zigh-Zagh is the ceiling support that allows you to create original pendant lamps, adapting both the shape and the length to every situation. Made in Italy, it can also be impregnated or painted with whichever colour you like. Included in the kit is a thin transparent thread and the ceiling hooks needed to hang up your creation.

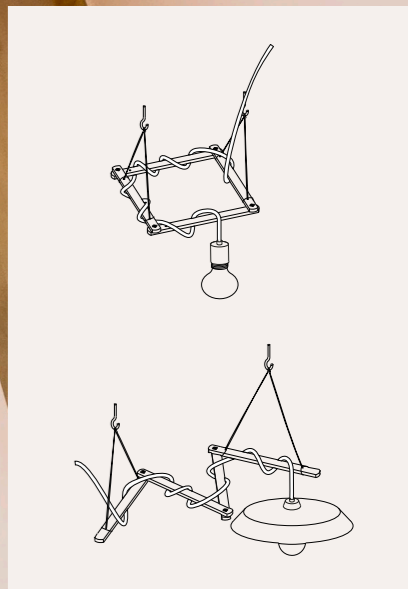
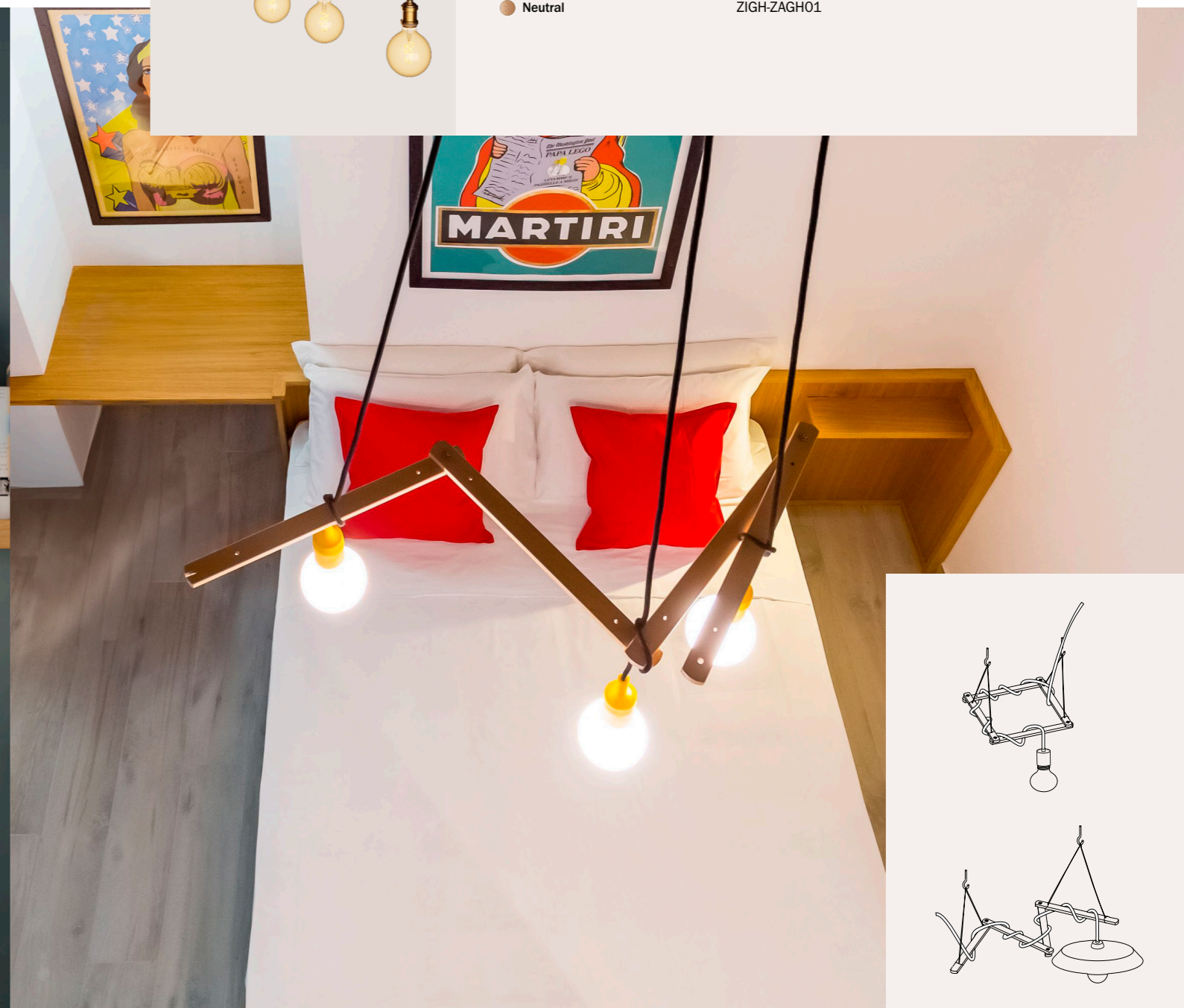
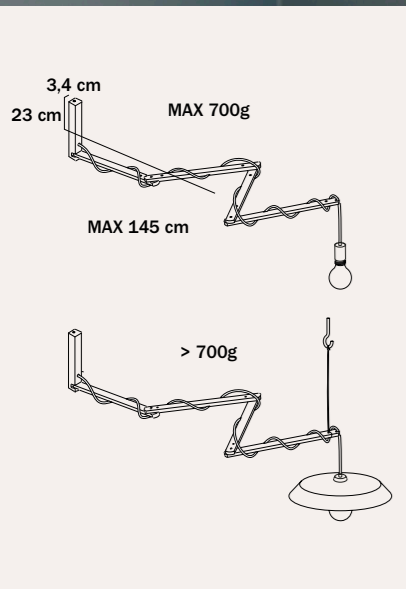

ROLÈ

The Rolè wooden cable tie is an ideal wall fixture for creating beautiful wall lighting solutions in your indoors spaces. It can be used to decentralise the fall of pendant lamp, or thanks to the use of many cable ties in a installations... and why not, you can use Rolè as a coat rack! Rolè is made of 100% Italian-made wood and is available in four finishes: beechwood, wenge-effect, black and white.

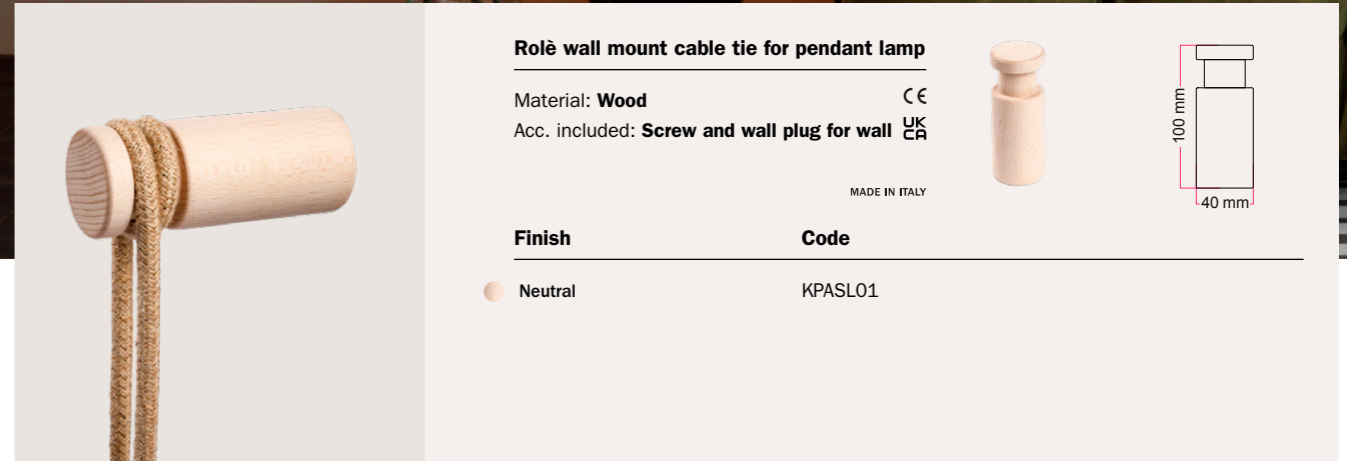
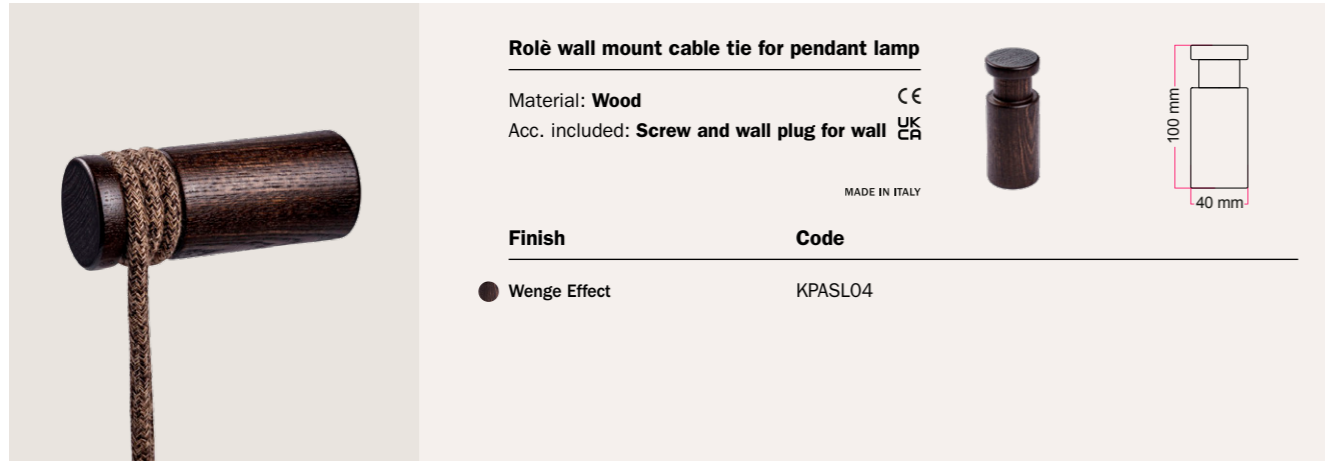
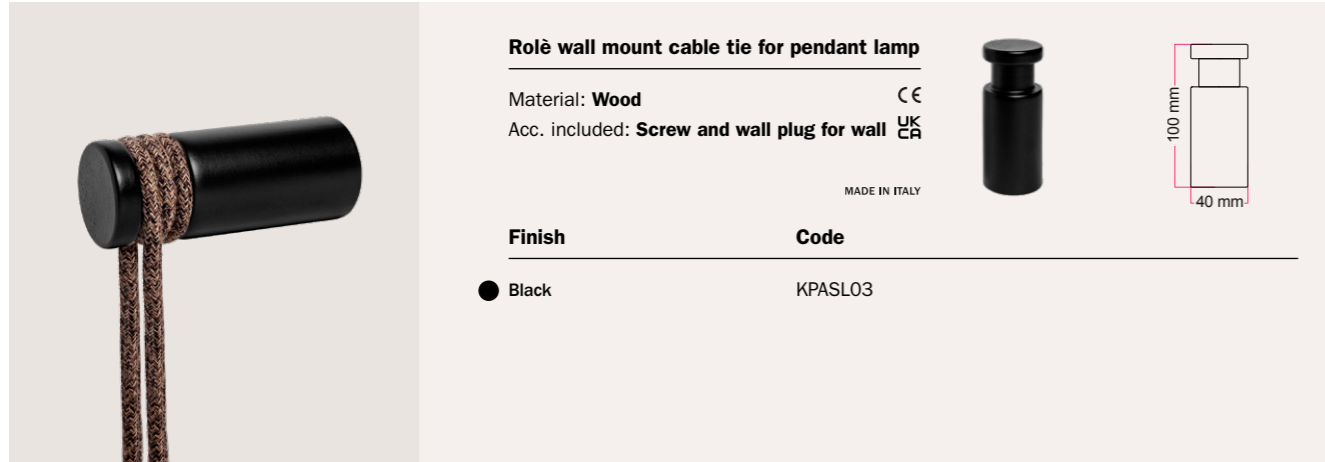
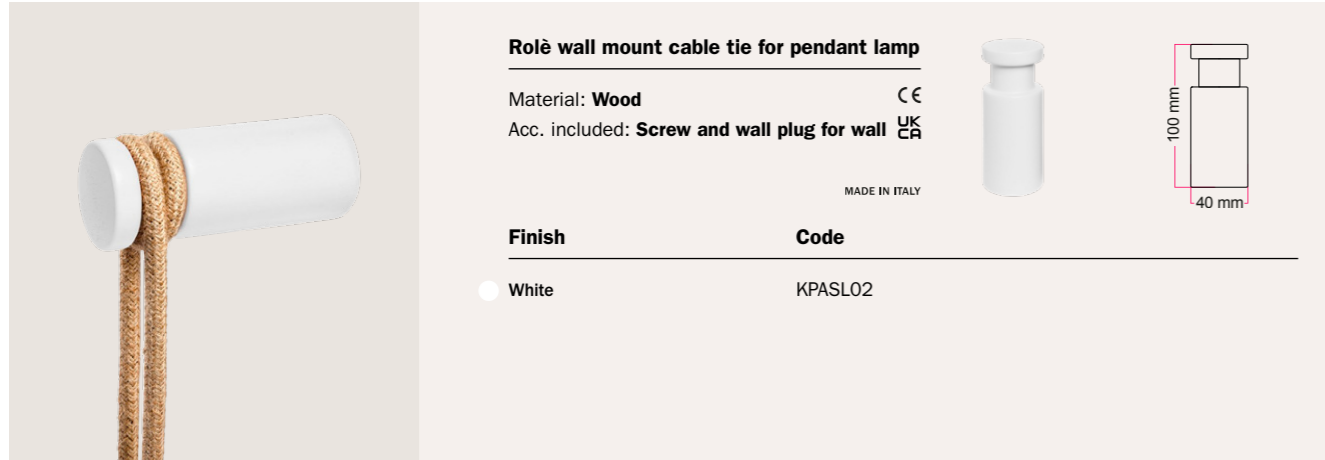

ARCHET(TO)

Archet(TO) is Creative Cables patented and Made in Italy solution to create a suspended lamp that can be hung onto a wall, even with a lampshade with a 70 cm maximum diameter and a 3,365 kg maximum weight it is bearing. It has a light structure in transparent polycarbonate and can be used with our lamps Snake and SnakeBIs.

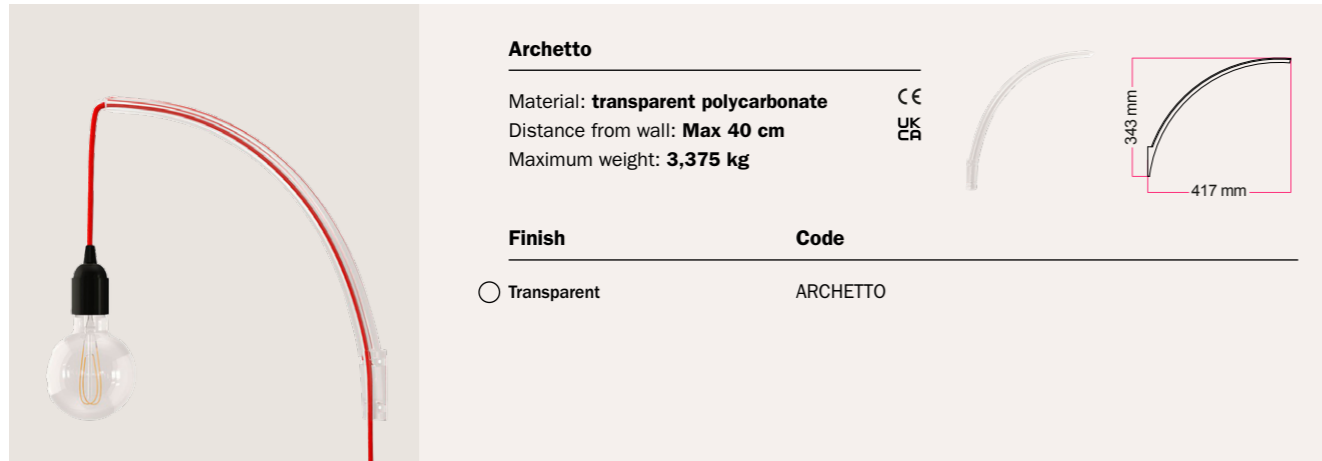

Archetto

Material: **transparent polycarbonate**
 Distance from wall: **Max 40 cm**
 Maximum weight: **3,375 kg**

CE
UK
CA

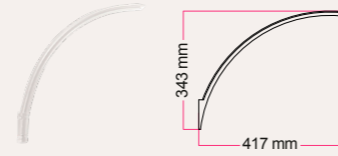

Finish

Code

Transparent

ARCHETTO



Square base for Archet(To) in wood

Material: **Wood**
 Acc. included: **square base, bracket, screws and dowels**

CE
UK
CA

MADE IN ITALY

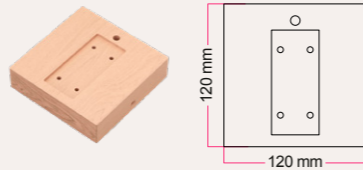

Finish

Code

- White
- Black
- Neutral

KRLQARC02
 KRLQARC03
 KRLQARC

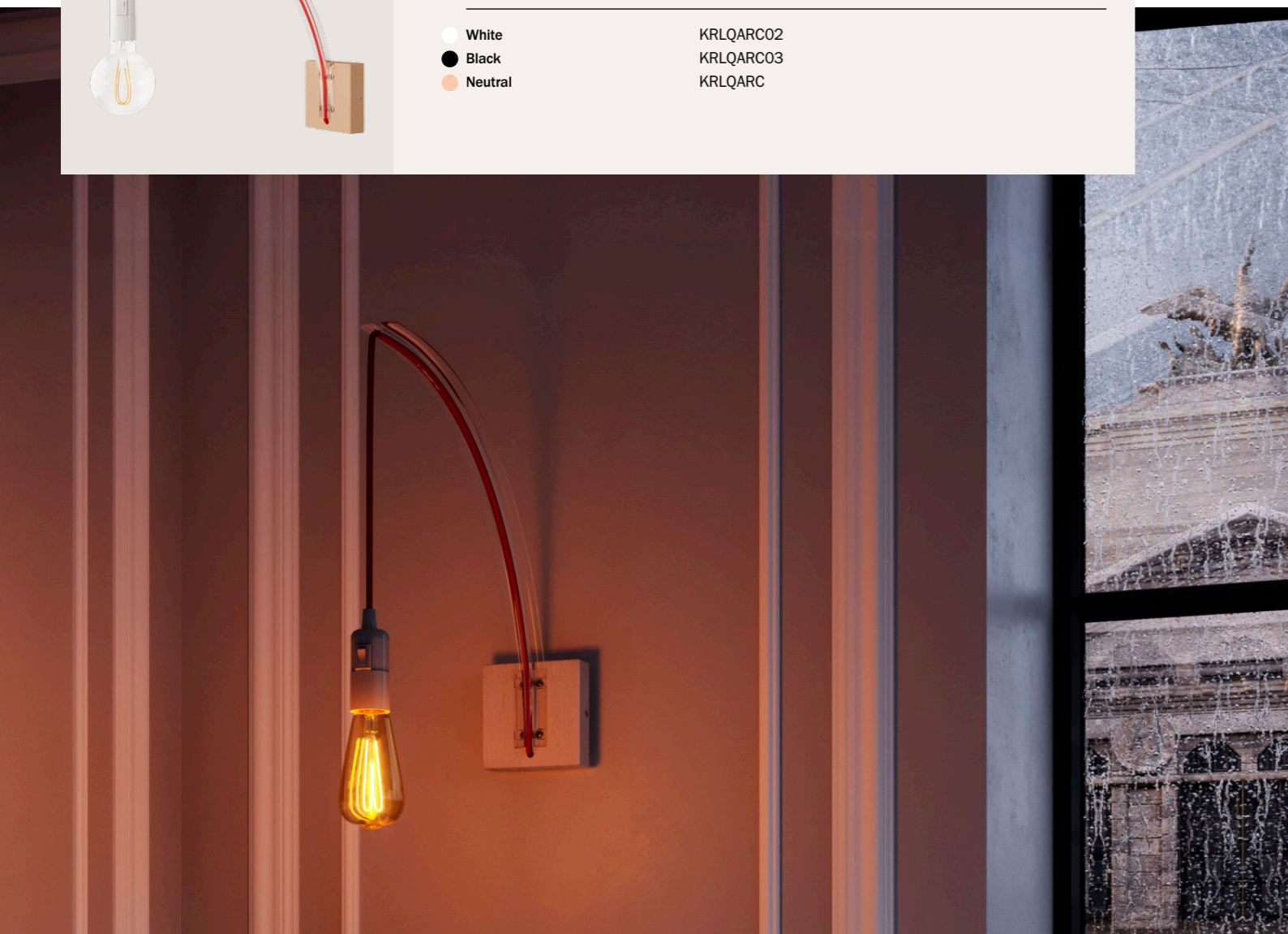

TACHÉ, LIGHT BULB SUPPORT

Taché, in Piedmontese means “to attach” or “to fix”: our Taché is a support for light bulbs that allows you to transform a Globe 125 into an original table lamp. Designer Fabrizio Alessio has imagined to adapt William Middlebrook’s idea (the paper clip) to the world of lighting, by drawing from its elegance and simplicity: just as the paper clip staples sheets of paper, Taché’s super-light structure can staple the globe of any G125 bulb, leaving it suspended and in view. The Taché consists of two mirrored arms with an aluminium wire frame covered with a braid made from the fabric of our cables and two elegant Made in Italy wooden feet. As well as a decorative function, the covering sleeve protects the bulb’s surface.



Taché - light bulb support

Material arm: **Coated aluminium wire** CE
 Material feet: **Beechwood** UK CA

MADE IN ITALY



Finish	Code
● Black	TCHRM04
● Black and White	TCHRT41
● Zig Zag Dark Grey	TCHRZ26
● Light Dusty Pink	TCHRM27
● White Blue	TCHRZ11
● Puzzle Green	TCHRX14
● Red	TCHRM09





TACHÉ

DESIGN BY FABRIZIO ALESSIO

One of the best Italian design project of 2021

WOODEN FEET KIT - TABLE LAMP SUPPORT

These beechwood feet made in Italy have a supporting purpose, allowing you to transform a lampshade into a table lamp base. They are equipped with double-sided adhesive tape to secure the lampshade and felt pads on the underside to ensure protection and adherence to the supporting surface. The wooden feet are available in different finishes to allow for a pleasant harmonious effect of your installation.



Feet Kit for table lamp

Material: **Wood** CE
 Adhesive tape: **12mm** UK CA

MADE IN ITALY



Finish	Code
● White	KPLBL02
● Black	KPLBL03
● Neutral	KPLBL01

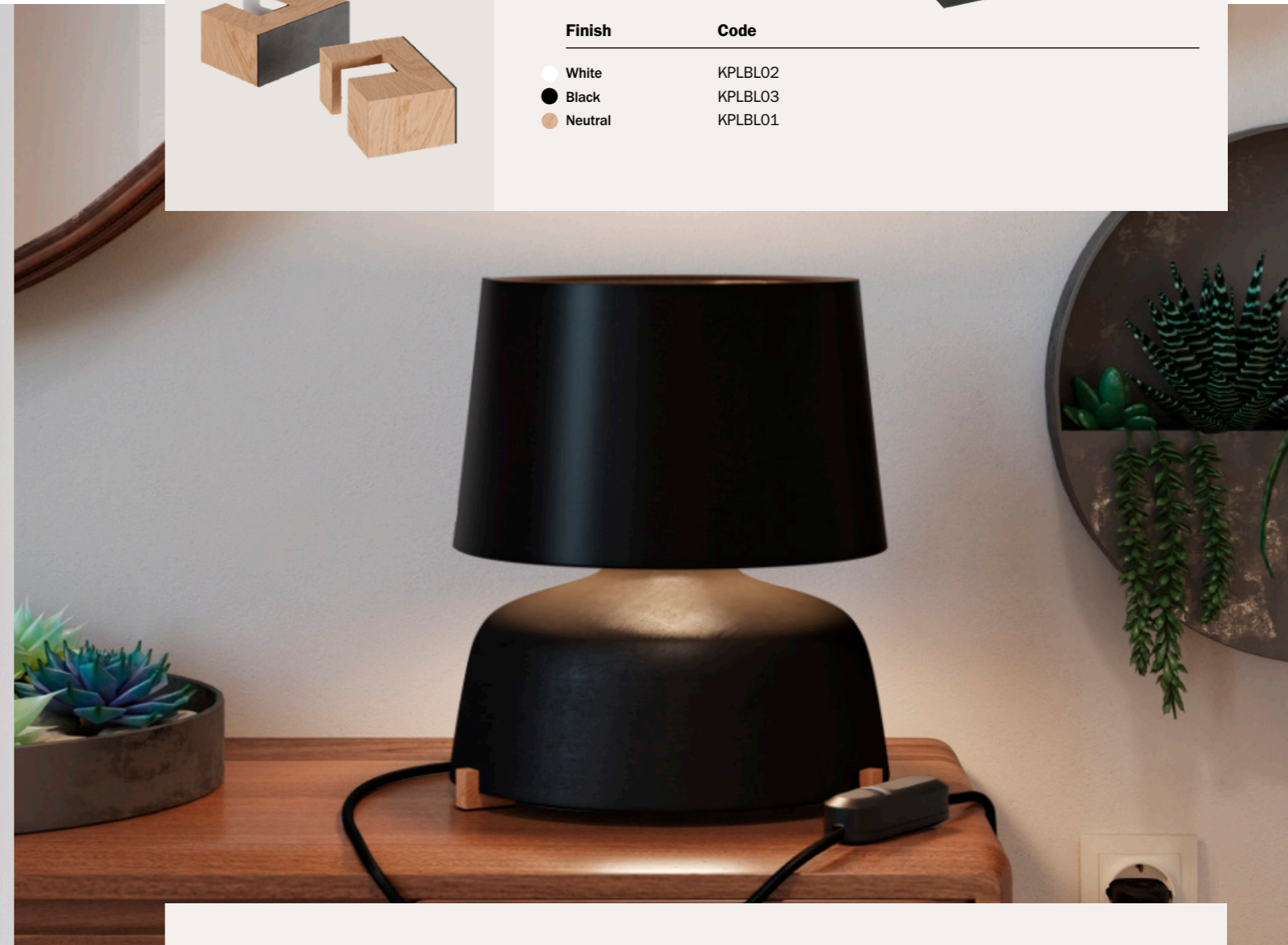

The extra idea

Transform one of our ceramic lampshades from the Materia collection into a table lamp base, add a fabric lampshade and a SnakeBis wiring kit: getting a 100% Made in Italy customized lamp it's easier with this Wooden feet kit!

WALL FIXTURES

Fairleads, hooks, decentralizers: these small pieces will give shape to your installation and allow you to run your cables exactly in the way you imagined.



Decentraliser, ceiling or wall mount 'V'

Material: **Plastic** CE
 Acc. included: **screw and wall plug Ø 4** UK CA

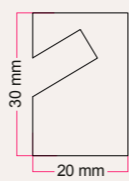
Finish **Code**

● White	DCG01BIA
● Black	DCG01NER
○ Transparent	DCG01TRA

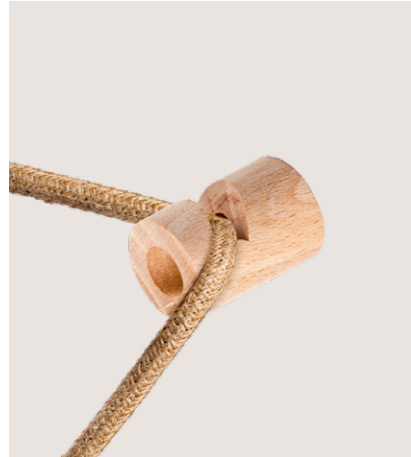

Decentraliser, ceiling or wall mount 'V'

Material: **Wood** CE
 Acc. included: **screw and wall plug Ø 4** UK CA

MADE IN ITALY

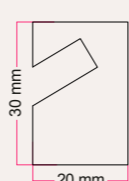
Finish **Code**

● Wenge effect	KDCGL04
● Neutral	KDCGL01



Decentraliser, ceiling hook

Material: **Plastic** CE
 Acc. included: **screw and wall plug Ø 4** UK CA

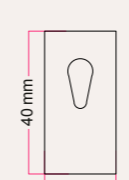
Finish **Code**

● White	DCS01BIA
● Black	DCS01NER
○ Transparent	DCS01TRA



Wall mounting universal fairlead

Material: **Plastic** CE
 Acc. included: **screw and wall plug Ø 4** UK CA
 Cables max 7mm: **2x0,75 - 3x0,75**

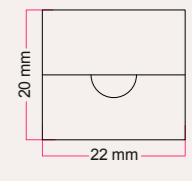
Finish **Code**

● White	FCP01BIA
● Black	FCP01NER
○ Transparent	FCP01TRA



Wall mounting universal for large cables

Material: **Plastic** CE
 Acc. included: **screw and wall plug Ø 4** UK CA
 Cables max 9mm: **3x1 - 3x1,5**

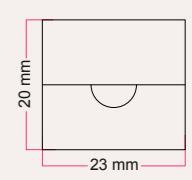
Finish **Code**

● White	FCP02BIAx2
● Black	FCP02NERx2
○ Transparent	FCP02TRAx2



Sarè - Wall mounting

Material: **Metal** CE
 Acc. included: **screw and dowel for wall** UK CA
 Cables: **2 or 3-pole round and stranded**

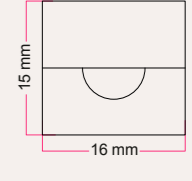
Finish **Code**

● Pearl Black	FCM01CF	● Brushed Bronze	FCM010TS
● Chrome	FCM01CR	● Copper	FCM01RA
● Brushed Titanium	FCM01TIS	● Brushed Copper	FCM01RAS
● Brass	FCM01GO		



Insulator for wall system

Material: **Porcelain** CE
 Insulator: **18mm** UK CA
 Screw and dowel: **Not Included**

MADE IN ITALY

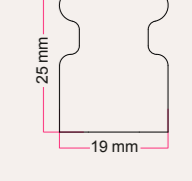
Finish **Code**

● White	PC1IS018
● Black	PC1IS018NE

CABLE CLAMPS

Cable Clamps are not just a safety feature: they can actually be beautiful and decorative. The metal cable clamps are available in standard size (1,7 cm) and XL size (7 cm and 15 cm).



Cable Clip Clamp

Material: **Plastic**
Hole size: **10mm**

CE
UK
CA



30 mm
14 mm

Finish	Code
White	SER01
Black	SER02
Transparent	SER00



Cylindrical Cable Clamp

Material: **Plastic**
Hole size: **10mm**
Threaded tube material: **metal**

CE
UK
CA



13 mm
17 mm
M10

Finish	Code
White	SERP1BI
Black	SERP1NE
Transparent	SERP1TR



Cylindrical Cable Clamp

Material: **Metal**
Hole size: **10mm**
Threaded tube material: **metal**

CE
UK
CA

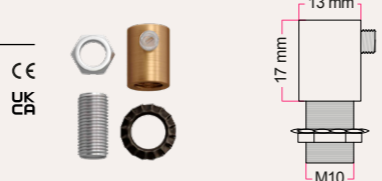

13 mm
17 mm
M10

Finish	Code
White	SERM1VB
Black	SERM1VN
Dark Rust	SERM1RU
Pearl Black	SERM1BR
Chrome	SERM1CR
Brushed Titanium	SERM1TIS
Brass	SERM1GO
Brushed Bronze	SERM1OTS
Copper	SERM1RA
Brushed Copper	SERM1RAS



Cylindrical Cable Clamp - 7 cm

Material: **Metal**
Hole size: **10mm**
Threaded tube material: **metal**

CE
UK
CA



13 mm
70 mm
M10

Finish	Code
White	SERM4VB
Black	SERM4VN
Dark Rust	SERM4RU
Pearl Black	SERM4BR
Chrome	SERM4CR
Brushed Titanium	SERM4TIS
Brass	SERM4GO
Brushed Bronze	SERM4OTS
Copper	SERM4RA
Brushed Copper	SERM4RAS



Cylindrical Cable Clamp - 15 cm

Material: **Metal**
Hole size: **10mm**
Threaded tube material: **metal**

CE
UK
CA



13 mm
150 mm
M10

Finish	Code
White	SERM5VB
Black	SERM5VN
Dark Rust	SERM5RU
Pearl Black	SERM5BR
Chrome	SERM5CR
Brushed Titanium	SERM5TIS
Brass	SERM5GO
Brushed Bronze	SERM5OTS
Copper	SERM5RA
Brushed Copper	SERM5RAS

ADJUSTABLE METAL JOINT

The adjustable metal joint is the perfect component to enhance your DIY lamp. It enables your lamp to tilt up to 90° and rotate 315°.



Adjustable metal joint

Material: **Metal**
Diameter: **1.6cm**

CE
UK
CA



60 mm
16 mm

Finish	Code
Pearl Black	TBS1BR
Chrome	TBS1CR
Brushed Titanium	TBS1TIS
Brass	TBS1GO
Brushed Bronze	TBS1OTS
Copper	TBS1RA
Brushed Copper	TBS1RAS

EXTENSION PIPES

Straight and bent extension pipes are available in different finishes and lengths: they can customize a wall or table lamp.



Extension tube 15 cm - hole 10 mm

Material: **Metal**
 Outside diameter: **13 mm**
 Inside diameter: **9 mm**

CE UK CA



Finish	Code
White	EXTELLE15VB
Black	EXTELLE15VN
Dark Rust	EXTELLE15RU
Pearl Black	EXTELLE15BR
Chrome	EXTELLE15CR
Brushed Titanium	EXTELLE15TIS
Brass	EXTELLE15GO
Brushed Bronze	EXTELLE15OTS
Copper	EXTELLE15RA
Brushed Copper	EXTELLE15RAS



Extension tube 5 cm - hole 10 mm

Material: **Metal**
 Outside diameter: **13 mm**
 Inside diameter: **9 mm**

CE UK CA



Finish	Code
White	EXTELLE05VB
Black	EXTELLE05VN
Dark Rust	EXTELLE05RU
Stainless Steel	EXTELLE05CR
Brushed Titanium	EXTELLE05TIS
Brushed Bronze	EXTELLE05OTS
Brushed Copper	EXTELLE05RAS

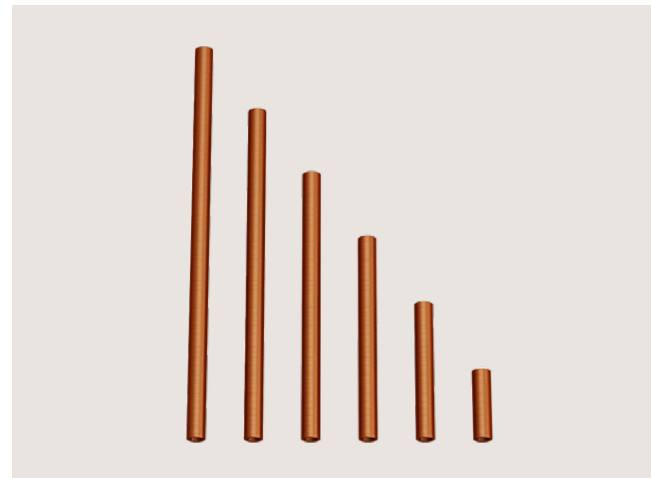

Metal extension tube - 5 cm

Material: **Metal** CE UK CA
 Outside diameter: **13 mm**
 Inner diameter: **9 mm**

Finish	Code
White	EXT05VB
Black	EXT05VN
Dark Rust	EXT05RU
Pearl Black	EXT05BR
Chrome	EXT05CR
Brushed Titanium	EXT05TIS
Brass	EXT05GO
Brushed Bronze	EXT05OTS
Copper	EXT05RA
Brushed Copper	EXT05RAS

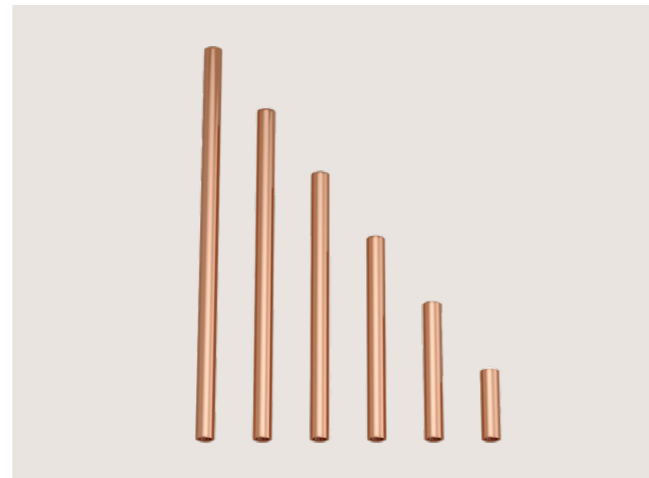

Metal extension tube - 10 cm

Material: **Metal** CE UK CA
 Outside diameter: **13 mm**
 Inner diameter: **9 mm**

Finish	Code
White	EXT10VB
Black	EXT10VN
Dark Rust	EXT10RU
Pearl Black	EXT10BR
Chrome	EXT10CR
Brushed Titanium	EXT10TIS
Brass	EXT10GO
Brushed Bronze	EXT10OTS
Copper	EXT10RA
Brushed Copper	EXT10RAS



Metal extension tube - 15 cm

Material: **Metal** CE UK CA
 Outside diameter: **13 mm**
 Inner diameter: **9 mm**

Finish	Code
White	EXT15VB
Black	EXT15VN
Dark Rust	EXT15RU
Pearl Black	EXT15BR
Chrome	EXT15CR
Brushed Titanium	EXT15TIS
Brass	EXT15GO
Brushed Bronze	EXT15OTS
Copper	EXT15RA
Brushed Copper	EXT15RAS

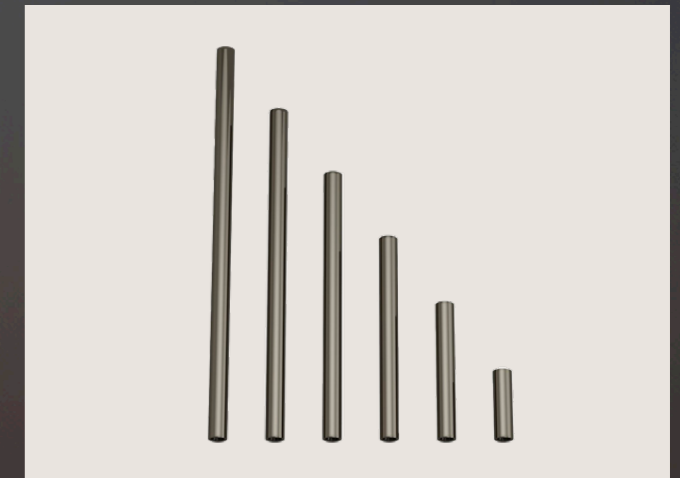

Metal extension tube - 20 cm

Material: **Metal** CE UK CA
 Outside diameter: **13 mm**
 Inner diameter: **9 mm**

Finish	Code
White	EXT20VB
Black	EXT20VN
Dark Rust	EXT20RU
Pearl Black	EXT20BR
Chrome	EXT20CR
Brushed Titanium	EXT20TIS
Brass	EXT20GO
Brushed Bronze	EXT20OTS
Copper	EXT20RA
Brushed Copper	EXT20RAS

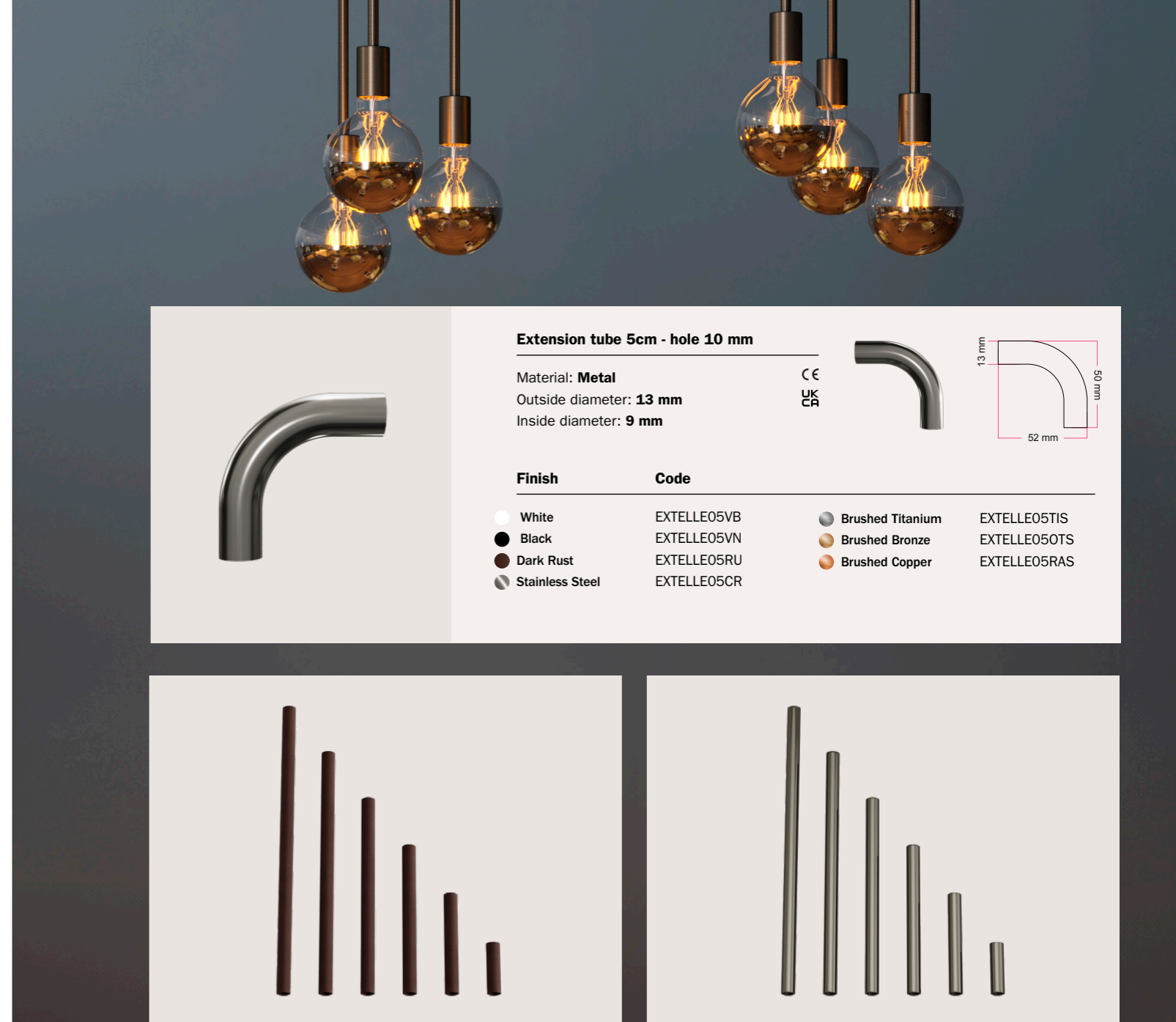

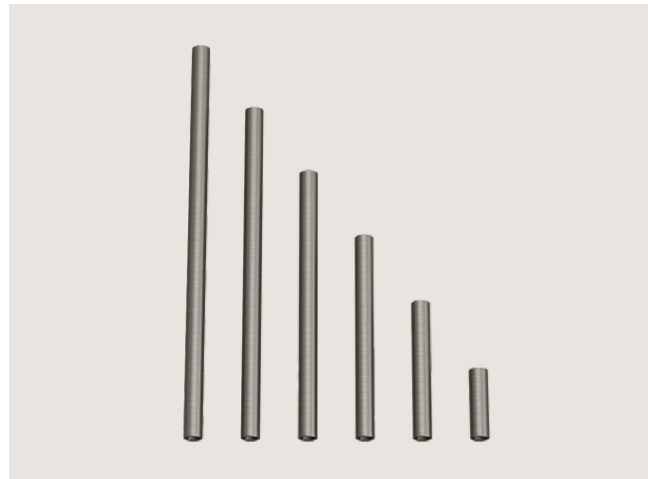

Metal extension tube - 25 cm

Material: **Metal** CE
UK
CA
 Outside diameter: **13 mm**
 Inner diameter: **9 mm**

Finish	Code
White	EXT25VB
Black	EXT25VN
Dark Rust	EXT25RU
Pearl Black	EXT25BR
Chrome	EXT25CR
Brushed Titanium	EXT25TIS
Brass	EXT25GO
Brushed Bronze	EXT25OTS
Copper	EXT25RA
Brushed Copper	EXT25RAS



Metal extension tube - 30 cm

Material: **Metal** CE
UK
CA
 Outside diameter: **13 mm**
 Inner diameter: **9 mm**

Finish	Code
White	EXT30VB
Black	EXT30VN
Dark Rust	EXT30RU
Pearl Black	EXT30BR
Chrome	EXT30CR
Brushed Titanium	EXT30TIS
Brass	EXT30GO
Brushed Bronze	EXT30OTS
Copper	EXT30RA
Brushed Copper	EXT30RAS

OTHER ACCESSORIES

Complete your project and satisfy your home-decorating urges with threaded tubes, threaded rods, terminals and wooden height adjusters. Some products are sold individually or in bulk boxes (10 or 100 pieces).

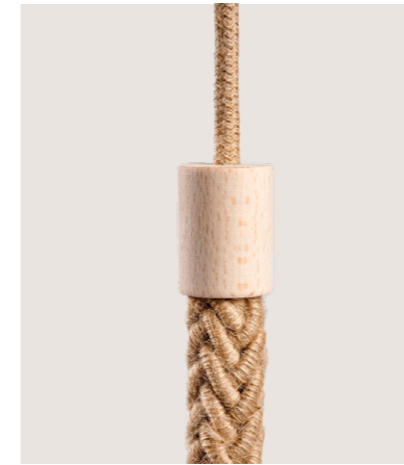

Terminal for 2XL rope cables

Material: **Wood** CE
UK
CA
 Top hole size: **Ø 10**
 Lower hole size: **Ø 24**
 Cables: **twisted cords 2XL 2x0,75**

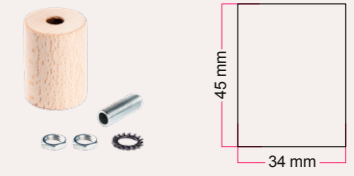

Finish	Code
Wenge effect	KTERCLS04
Neutral	KTERCLS01



Kit with 2 threaded tubes + 4 nuts

Material: **Metal** CE
UK
CA
 Threaded pipe material: **Metal**
 Threaded tube dimension: **Diameter M10x1**

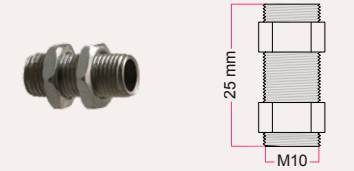

Finish	Code
Metal	30180

SUSPENSION LAMP ACCESSORIES

Thanks to this simple accessory in untreated neutral wood, you can regulate easily the height of any suspension lamp. You can also use it to create drawings and give more evidence to the colors of the fabric cable.

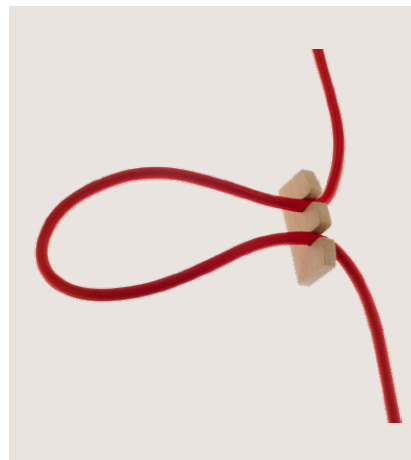

Suspension lamp height regulator

Material: **Beechwood** CE
UK
CA



Finish	Code
Neutral	ELEG03

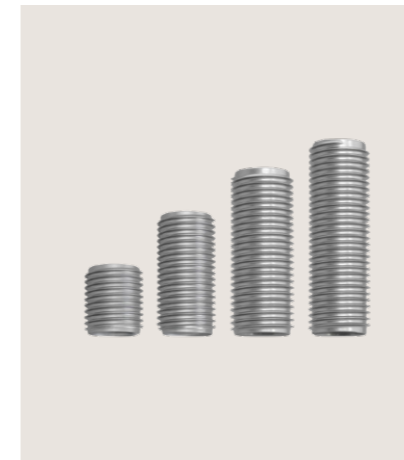

Threaded tubes - 10 pieces

Material: **Metal** CE
UK
CA

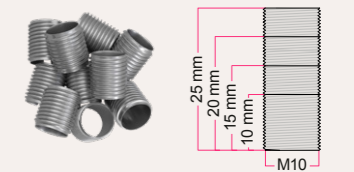

Finish	Code	Cm
Metal	PC10TIGE10	1 cm
Metal	PC10TIGE15	1,5 cm
Metal	PC10TIGE20	2 cm
Metal	PC10TIGE25	2,5 cm



CREATIVE FLEX

When flexibility takes shape

Creative Flex is the lighting system for creating single and multiple pendant lamps in all the shapes and finishes your imagination can suggest. It is bendable and adjustable with different torsions, available in 3 lengths to give shape to any lighting requirement and, obviously, customisable with 20 coatings and 5 finishes for the terminal. The ultimate in flexibility, don't you think?

Patented Solution
MADE IN ITALY

CREATIVE FLEX









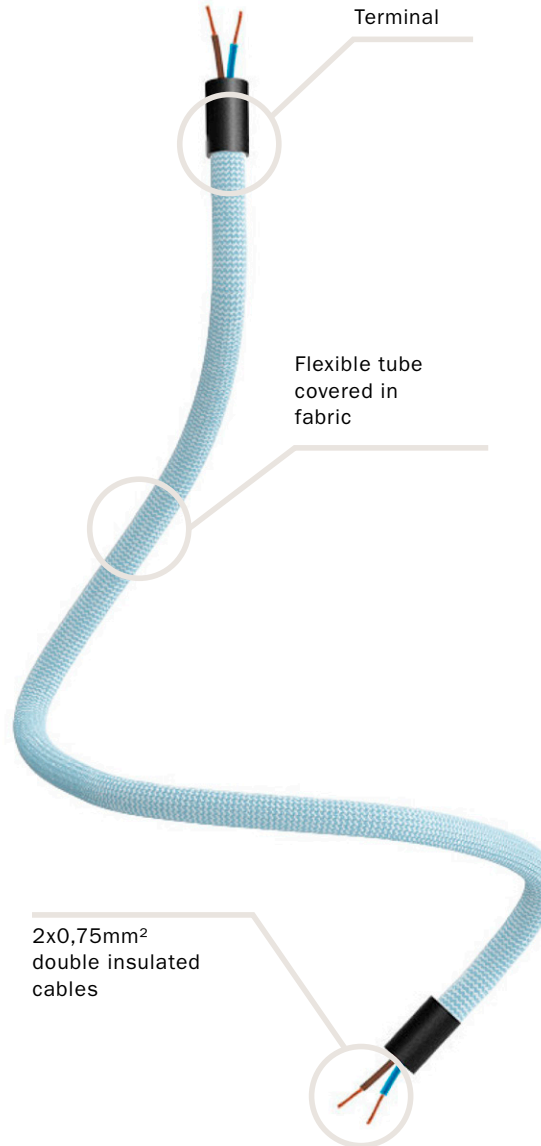

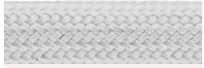







When flexibility takes shape.

Creative Flex is our completely flexible illumination system because you can model, bend, twist and regulate as you wish with many a torsion. Flex System is ideal to create single and multi-fall pendant, wall lamps or table lamps inspired by the most imaginative ideas, yours!
Be creative and design your own lighting system.

Fabric covering and terminals

We offer a selection of 20 colors for your fabric coverings, that seamlessly blend into any environment. Our terminals offer a seamless blend with your chosen fabric covering. Find the perfect match among our five finishes to achieve a harmonious fusion of style and functionality.



 RM01 30CM FLEX30RM01 60CM FLEX60RM01 90CM FLEX90RM01	 RM02 30CM FLEX30RM02 60CM FLEX60RM02 90CM FLEX90RM02	 RZ04 30CM FLEX30RZ04 60CM FLEX60RZ04 90CM FLEX90RZ04			
 RM04 30CM FLEX30RM04 60CM FLEX60RM04 90CM FLEX90RM04	 RM19 30CM FLEX30RM02 60CM FLEX60RM02 90CM FLEX90RM02	 RM09 30CM FLEX30RZ04 60CM FLEX60RZ04 90CM FLEX90RZ04			
 RN06 30CM FLEX30RN06 60CM FLEX60RN06 90CM FLEX90RN06	 RM79 30CM FLEX30RM79 60CM FLEX60RM79 90CM FLEX90RM79	 RM73 30CM FLEX30RZ73 60CM FLEX60RZ73 90CM FLEX90RZ73	 RM74 30CM FLEX30RZ74 60CM FLEX60RZ74 90CM FLEX90RZ74	 RM13 30CM FLEX30RZ13 60CM FLEX60RZ13 90CM FLEX90RZ13	 RZ22 30CM FLEX30RZ22 60CM FLEX60RZ22 90CM FLEX90RZ22
 RZ24 30CM FLEX30RZ24 60CM FLEX60RZ24 90CM FLEX90RZ24	 RM75 30CM FLEX30RM75 60CM FLEX60RM75 90CM FLEX90RM75	 RZ30 30CM FLEX30RZ30 60CM FLEX60RZ30 90CM FLEX90RZ30	 RM72 30CM FLEX30RZ72 60CM FLEX60RZ72 90CM FLEX90RZ72	 RM20 30CM FLEX30RM20 60CM FLEX60RM20 90CM FLEX90RM20	 RM78 30CM FLEX30RM78 60CM FLEX60RM78 90CM FLEX90RM78
 RM76 30CM FLEX30RM76 60CM FLEX60RM76 90CM FLEX90RM76	 RM77 30CM FLEX30RM77 60CM FLEX60RM77 90CM FLEX90RM77				

Transform your ideas with Flex 30 cm

If you're in search of a customizable ceiling lamp, Flex 90 cm is the perfect solution for you. Its flexible extensions, moldable with your own hands, can be bent and twisted to create the lamp you've been looking for. To maintain the shape of your lamp, bend and flex Flex along its entire length.

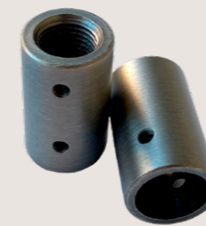

Creative Flex - Terminal

Terminal: **Metal**
Diameter: **10 mm**
Length: **30mm, 60mm, 90mm**

CE

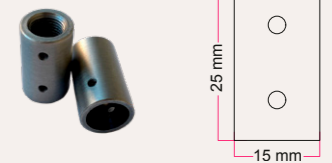

Finish	Code	Finish	Code
● Matt White	SERMF10VBO	● Brushed Bronze	SERMF100TS
● Black	SERMF10VN	● Brushed Copper	SERMF10RAS
● Brushed Titanium	SERMF10TIS		

Tailor your Flex 60 cm

Whether used individually or in multiple combinations, the 60 cm Flex is the solution for those seeking a wall or ceiling lamp to customize repeatedly with a simple twist of the hands.



Flex adapts to every need

When flexibility takes shape.

Give your Creative Flex the shape you desire by choosing from one of the three available lengths: 30 cm, 60 cm, and 90 cm. Whatever your lighting requirements may be, we're confident you can meet them.

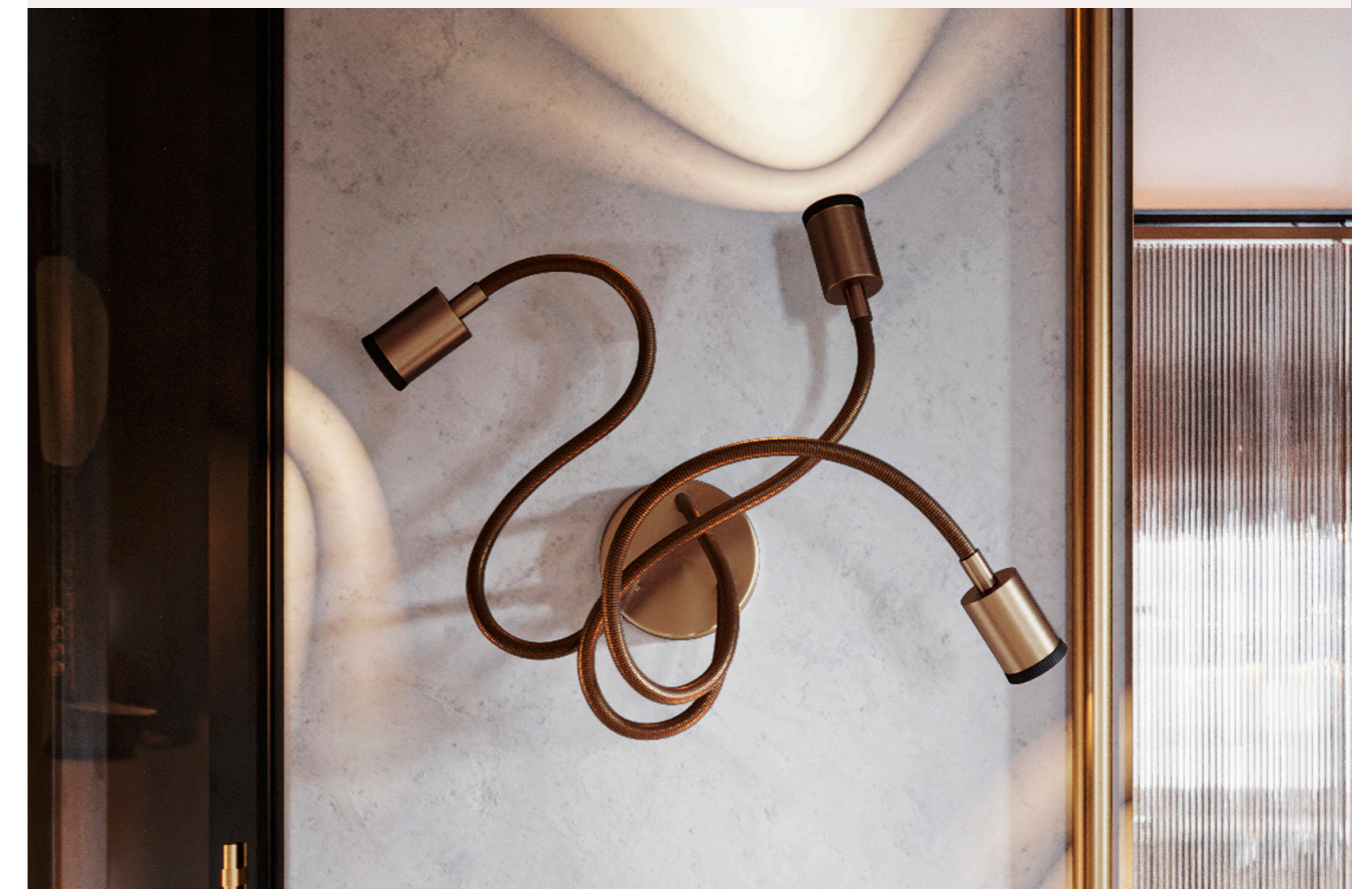
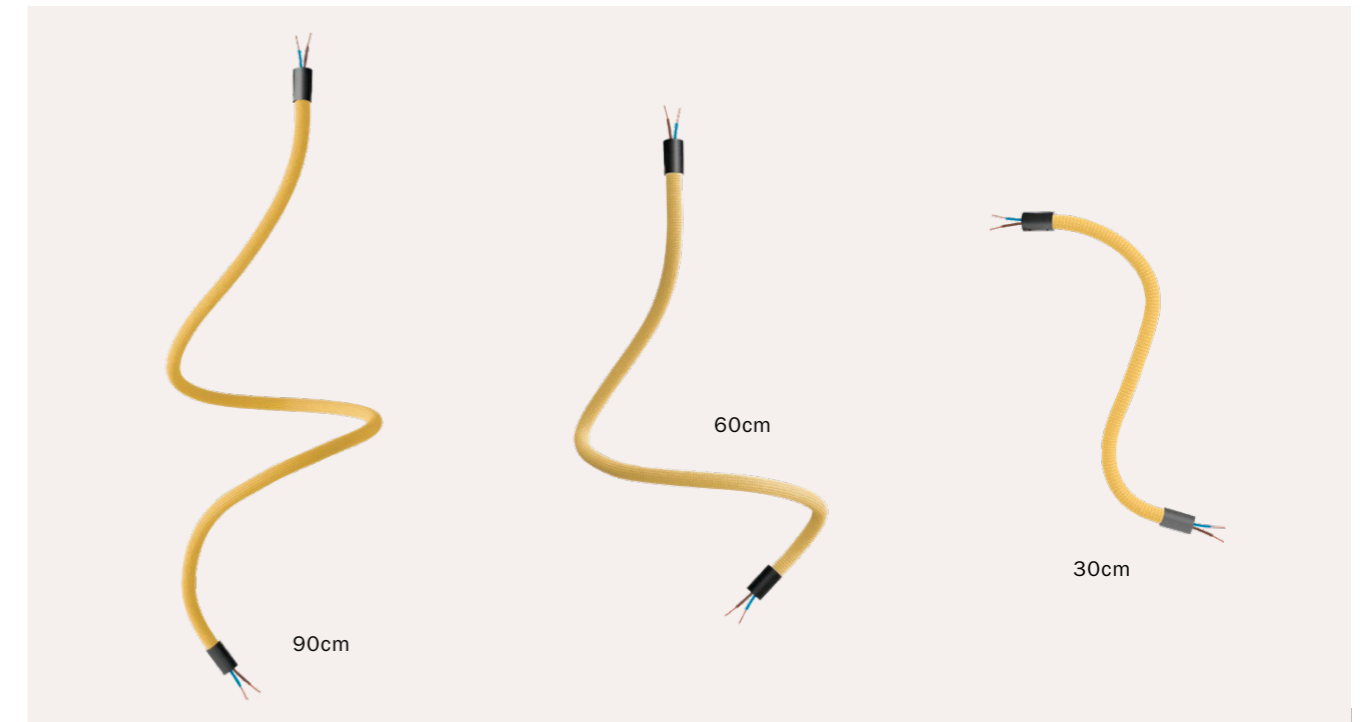

Compose your own design

The Creative Flex kit includes a flex, the adjustable flexible tube, and a pair of metal terminals. We provide you with hundreds of options to create your Creative Flex Kit, but don't worry, your warehouse will also remain flexible: based on the requests of your customers, you can also purchase the different options individually.

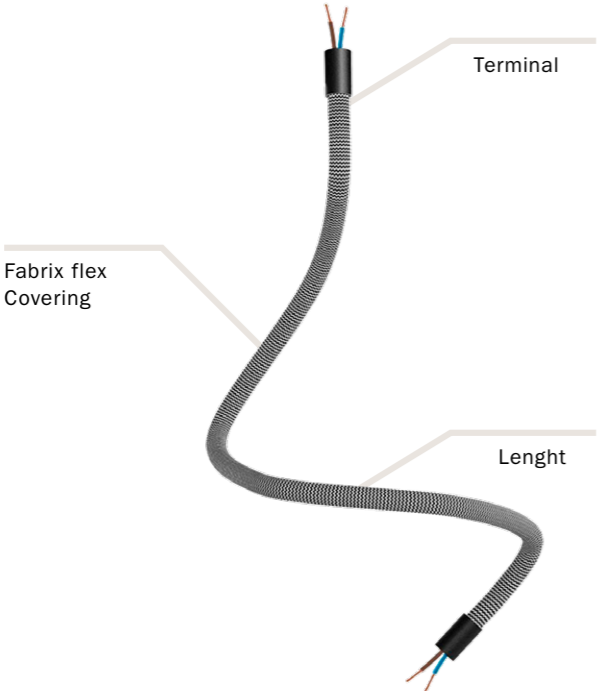

KFLEX KIT FLEX	90 LENGTH	VN TERMINALS	RM79 FABRIX FLEX COVERING
--------------------------	---------------------	------------------------	-------------------------------------

LENGHT

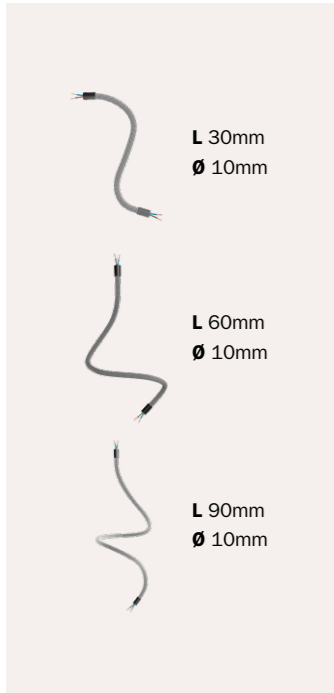

FABRIX FLEX COVERING

Finish	Code
Matt White	RM01
Glossy Silver	RM02
Titanium	RM75
Black and White	RZ04
Iron Black	RZ30
Glossy Charcoal Black	RM04
Black and Gold	RZ24
Whiskey Black	RZ22
Copper	RM74
Glossy Fire Red	RM09
Glossy Bordeaux	RM19
Glossy Espresso Brown	RM13
Bronze	RM73
Mustard	RM79
Light Mélange	RM72
Baby Blue	RM76
Petrol Blue	RM78
Glossy Deep Blue	RM20
Grass Green	RM77

TERMINALS

Finish	Code
Matt White	VBO
Black	VN
Brushed Titanium	TIS
Brushed Bronze	TS
Brushed Copper	RAS



Elevate your ceiling with this added idea: Flex 90 cm

If you're in search of a customizable ceiling lamp, Flex 90 cm is the perfect solution for you. Its flexible extensions, moldable with your own hands, can be bent and twisted to create the lamp you've been looking for. To maintain the shape of your lamp, bend and flex Flex along its entire length.



CAGE

Looking for a modular chandelier in true Creative Cables style? Cage is the answer to your every need thanks to its clean shape that encloses the cables to create dazzling and unique suspension lamps. We like to think of them as floating sculptures.

They are available round or squared, in 3 different finishes: black or white in recycled plastic and transparent in polycarbonate.

Change shape

If you get tired of your current display, switch up your lamp's appearance each and every time you want to by simply adding new Cages to your current one or by adjusting its placement. For unique and captivating shapes.

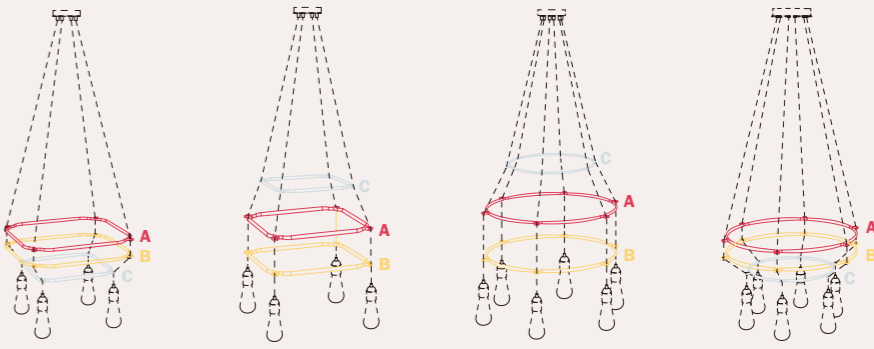

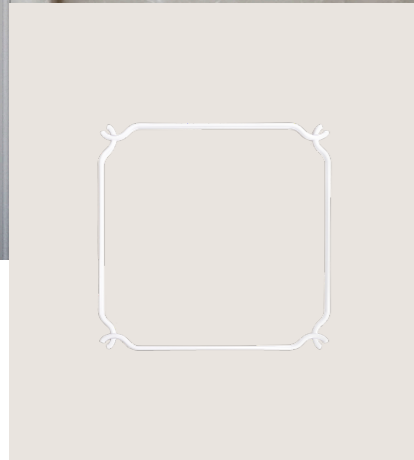

Square Cage - Structure for lamps

Structure Material: **Polycarbonate** CE
 Modules: **4** UK
 Size: **S** CA

Finish	Code
● White	CGQ34BIA
● Black	CGQ34NER
○ Transparent	CGQ34TRA

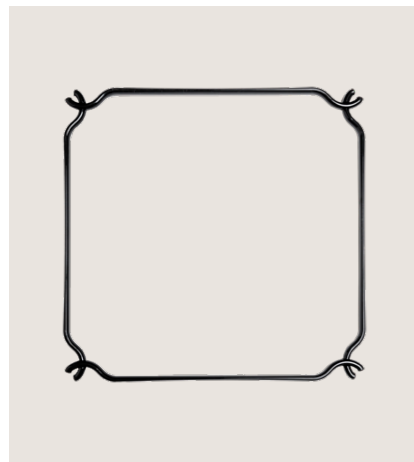
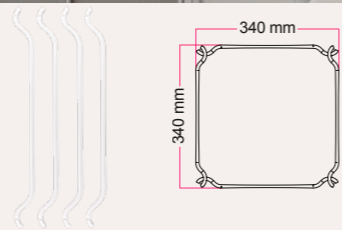

Square Cage - Structure for lamps

Structure Material: **Recycled plastic** CE
 Modules: **4** UK
 Size: **M** CA

Finish	Code
● White	CGQ34BIA
● Black	CGQ34NER
○ Transparent	CGQ34TRA

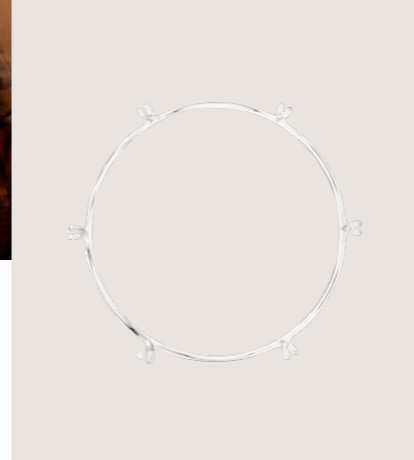
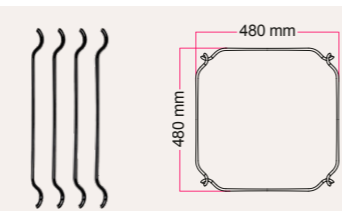

Circle Cage - Structure for lamps

Structure Material: **Polycarbonate** CE
 Modules: **6** UK
 Size: **S** CA

Finish	Code
● White	CGR40BIA
● Black	CGR40NER
○ Transparent	CGR40TRA

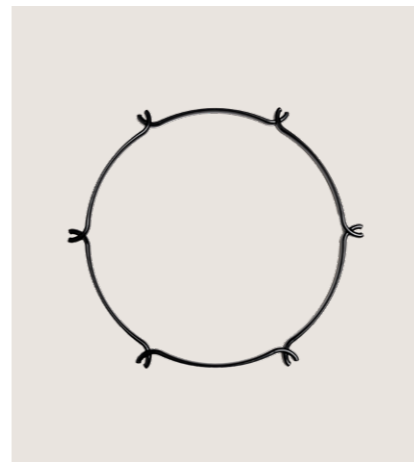
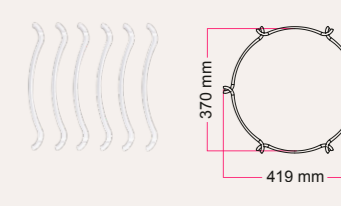

Circle Cage - Structure for lamps

Structure Material: **Recycled plastic** CE
 Modules: **6** UK
 Size: **M** CA

Finish	Code
● White	CGR40BIA
● Black	CGR40NER
○ Transparent	CGR40TRA

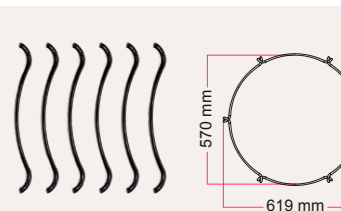



ELECTRICAL COMPONENTS

Every electrical accessory you can think of to create your own personal design: plugs, sockets, switches, dimmers, and much more.

All certified to the strictest Italian and European safety standards.

SWITCHES DESIGNED BY ACHILLE CASTIGLIONI

The legendary 450, was born more than 50 years ago from the pencil of one of the protagonists of Italian design, winner of nine Golden Compasses.

The sound of the operating 'click' has entered the collective imagination of every person since, as this small object has been produced more than 25 million times. But 450 isn't the only switch designed by Achille and Pier Giacomo Castiglioni: there are two "big brothers" designed for floor and table lamps: the 661 and the 662.



Special thanks to the Achille Castiglioni Foundation for the support



Unipolar Slider Switch

Material: **Thermoplastic** CE
UK
CA
 Rated voltage: **250V**
 Lamp load: **1A**
 Cable: **H03VVH2-F - 2 x 0.75 mm²**

Finish	Code
● White	CAST450B
● Black	CAST450N



Unipolar wire breaker push rocker switch

Material: **Plastic** CE
UK
CA
 Rated voltage/Lamp load: **250V/1A**
 Cable: **H03VVH2-F, H03VVV-F 2/3x0.75mm²**
H05VVH2-F, H05VV-F 2/3x0.75mm²

Finish	Code
● White	CAST92B
● Black	CAST92N

Unipolar Foot Switch

Material: **Bakelite** CE
UK
CA
 Rated voltage/Lamp load: **250V/2A**
 Cable: **H03VVH2-F, H03VVV-F 2/3x0.75mm²**
H05VVH2-F, H05VV-F 2/3x0.75mm²

Finish	Code
● Black	CAST661N

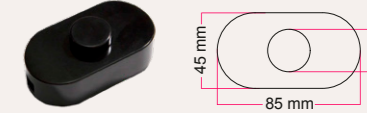

Double Single-Pole Foot Switch

Material: **Bakelite** CE
UK
CA
 Rated voltage/Lamp load: **250V/2A**
 Cable: **H03VVH2-F, H03VVV-F 2/3x0.75mm²**
H05VVH2-F, H05VV-F 2/3x0.75mm²



Finish	Code
● Black	CAST662N



SWITCHES

Inline double-pole switch

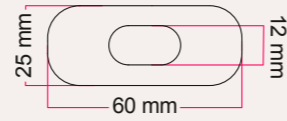
Material: **Thermoplastic**
 Rated voltage: **250V**
 Resistive/Inductive/lamp load: **2A/1A/1A**
 Cable: **H03VVH2-F - H03VV-F, 2x0.75mm²**

Base colour: **White**

Button Colour	Code
● White	INTRFBB



Base colour: **Black**

Button Colour	Code
● Black	INTRFMN



Base colour: **Transparent**

Button Colour	Code
○ Transparent	INTRFBT
● Gold	INTRFBO

CREATIVE SWITCHES

Tired of the classic single-colour switch?
 With the Creative Switch, you can combine the shell of the switch with different colours of the button and create the perfect combination with our cables. All you have to do is customise your lamp in every detail, even the switch!

Inline single-pole switch

Material: **Thermoplastic**
 Rated voltage: **250V**
 Resistive/Inductive/lamp load: **2A/1A/1A**
 Cable: **H03VVH2-F - H03VV-F, 2x0.75mm²**

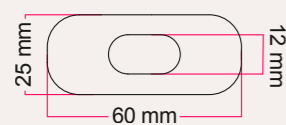
Base colour: **White**

Button Colour	Code
● Black	INTRFMBIANER
● Titanium	INTRFMBIATIS
● Bronze	INTRFMBIAOTS
● Copper	INTRFMBIARAS
● Petrol	INTRFMBIAPE
● Soft blue	INTRFMBIASB
● Soft green	INTRFMBIAVE
● Mustard yellow	INTRFMBIAMU
● Wood Effect	INTRFMBIALW
● Wenge Effect	INTRFMBIALEG
● Carbon Fiber Effect	INTRFMBIACAR
☼ Pied de poule	INTRFMBIAPPP

Base colour: **Black**

Button Colour	Code
● White	INTRFNERBIA
● Titanium	INTRFMNERTIS
● Bronze	INTRFMNEROTS
● Copper	INTRFMNERRAS
● Petrol	INTRFMNERPE
● Soft blue	INTRFMNERSB
● Soft green	INTRFMNERVE
● Mustard yellow	INTRFMNERMU
● Wood Effect	INTRFMNERLW
● Wenge Effect	INTRFMNERLEG
● Carbon Fiber Effect	INTRFMNERCAR
☼ Pied de poule	INTRFMNERPPP

FOOT SWITCHES

Foot Switches are usually used for floor lamps, but their fun and unusual nature makes them perfect components even for table lamps. In addition to that, our buttons come in cool and unusual colour palettes. To give every lamp that unique and fun flair.

Inline single-pole foot switch

Material: **Plastic**
 Rated voltage: **250V**
 Resistive/lamp load: **2A/1A**
 Cable: **H03VVH2-F - H03VV-F, 2-3x0.75mm²**

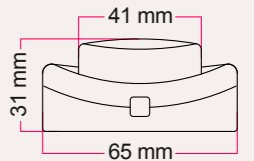



Base colour: **White**

Button Colour	Code
● White	INTPEDB



Base colour: **Black**

Button Colour	Code
● Black	INTPEDN



Base colour: **Transparent**

Button Colour	Code
○ Transparent	INTPEDT

399 & 400 CYLINDRICAL SWITCHES

Cylindrical in shape and compact in size, these switches provide a practical way to adjust the power supply. With their distinctive appearance, they offer timeless versatility for those seeking to add a unique touch to their table lamp.



NEW

Rewireable cylindrical cord-operated switch

Material: **Thermoplastic resin** CE

Rated voltage: **250V** UK

Cable: **2x0.75mm² - 3x0.75mm²** CA

Resistive/Inductive/lamp load: **2A/0,5A/0,5A** ⊕

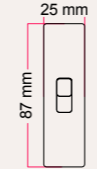
Finish	Code
● White	400B
● Black	400N



NEW



Rewireable cylindrical rocker switch

Material: **Thermoplastic resin** CE

Rated voltage: **250V** UK

Cable: **2x0.75mm² - 3x0.75mm²** CA

Resistive/Inductive/lamp load: **2A/0,5A/0,5A** ⊕



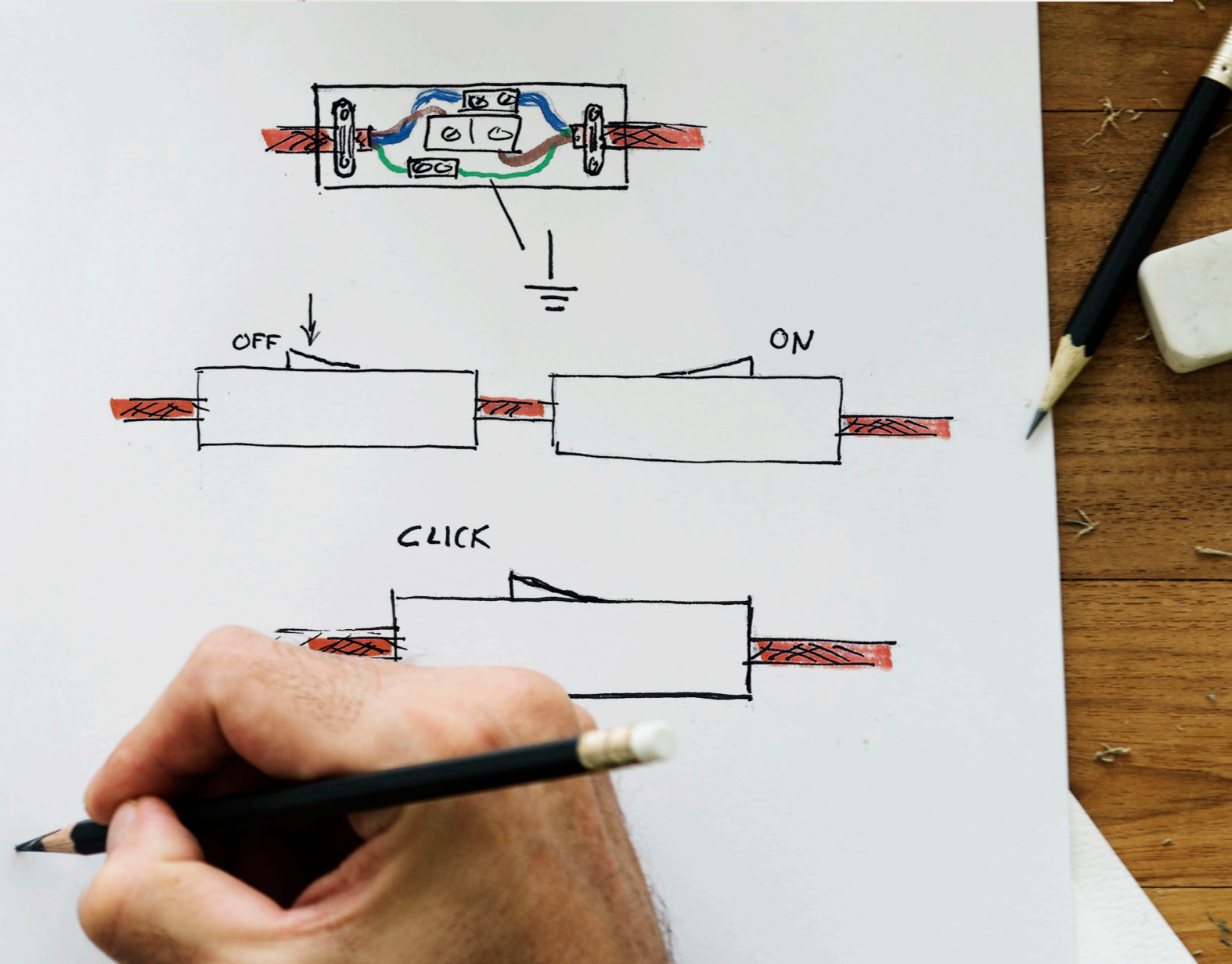
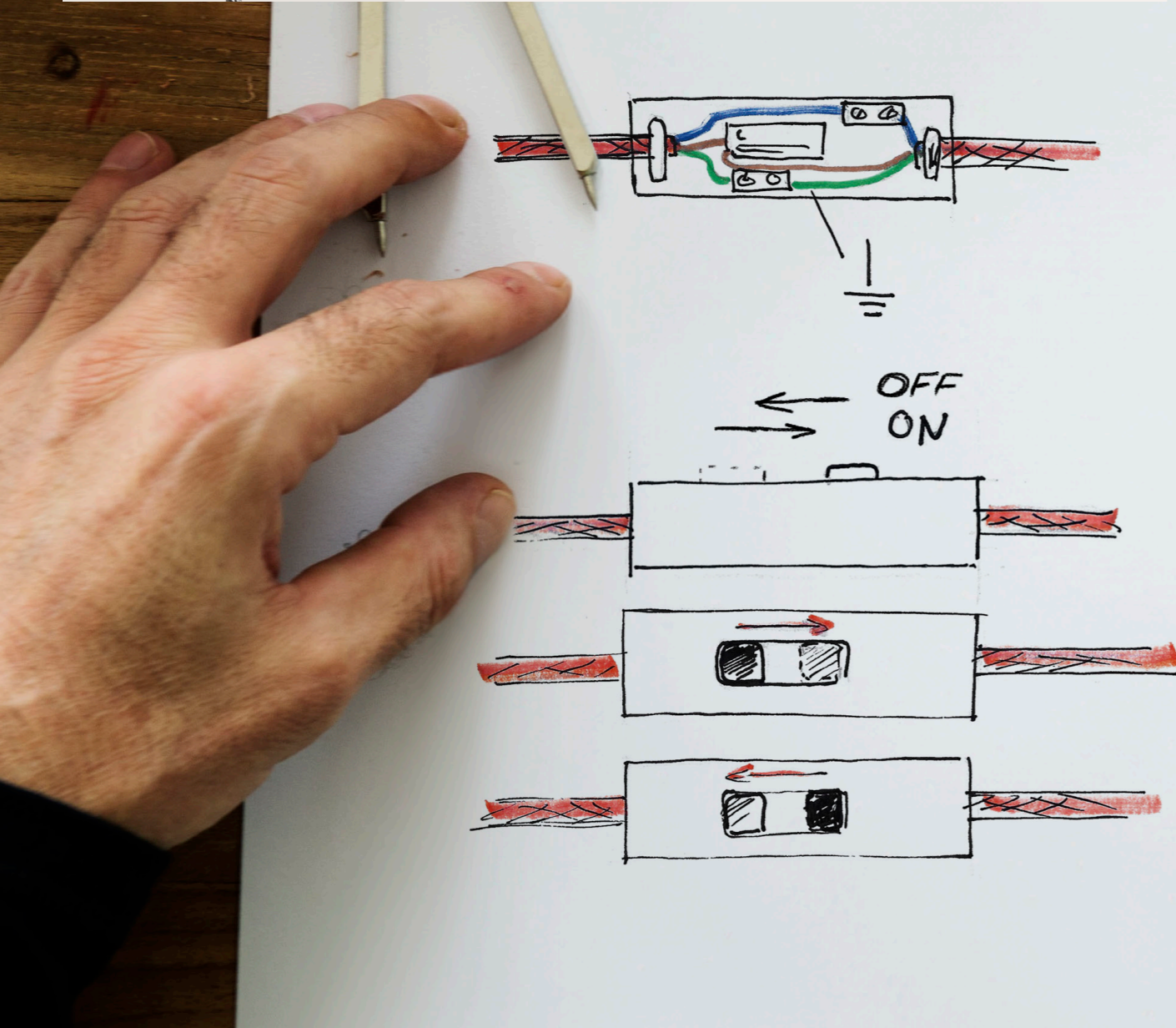

Finish	Code
● White	399B
● Black	399N



DIMMER

Dimmers let you adjust the light intensity of a light bulb according to your personal need.



Dimmer with inline switch

Material: **Thermoplastic**

Rated voltage: **220-240V**

Power range: **4-25W^{LED} / 4-150W^{INC} / 11-25W^{CFL}**

Cable: **H03VVH2-F 2x0,75 mm² - H03VV-F 2x0,75 mm²**

CE UK CA

97 mm
31 mm

Finish	Code
White	ARD037536
Black	ARD036827
Transparent	ARD037399
Gold	ARD037433

Schuko IP44 plug

This black plastic Schuko plug may be used to create lighting with outdoor cables and EIVA system components. The IP44 protection rating of this plug means it's protected against splashes and spray.



Black Schuko plug with ring

Material: **Technopolymer**

Voltage: **250 V**

Rated Current: **16A**

Poles: **2P+T**

CE UK CA

62 mm
96 mm

Finish	Code
Black	80052

IP44 WATER RESISTANT

CREATIVE PLUG

Give your lamp a boost of colour by combining the 5 colours of Creative Plug with the different options of Creative Switch. Creative European Plug is compatible with all our 2x0.75 cables and can be combined with other Creative Cables components.



Creative Plug 2-pole

Material: **Thermoplastic**

Voltage: **250 V**

Rated Current: **10A**

Cables: **2x0.75mm²**

CE UK CA

36 mm
39 mm

Finish	Code	Finish	Code
Wood Effect	SPSEULW	Bronze	SPSEUOTS
Wenge Effect	SPSEULEG	Copper	SPSEURAS
Titanium	SPSEUTIS		

PLUGS AND SOCKETS

Explore our range of plugs and sockets, combining form and function seamlessly. Elevate your power solutions with our stylish and efficient designs.



Plug 2-pole

Material: **Thermoplastic**

Voltage: **250 V**

Rated Current: **10A**

Cables: **2x0.75mm²**

CE UK CA

36 mm
39 mm

Finish	Code
White	SPSEUB
Black	SPSEUN



Two-Pole Plug

Material: **Thermoplastic**

Voltage: **250 V**

Rated Current: **10A**

Cables: **2x0.75mm²**

CE UK CA

46 mm
32 mm

Finish	Code
White	82500-E
Black	82501-E
Transparent	SPIT2PT

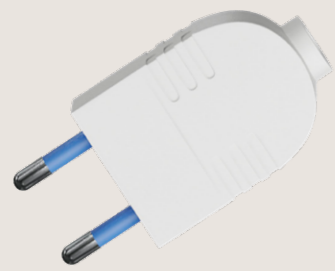

Two-Pole Plug

Material: **Thermoplastic**
 Voltage: **250 V**
 Rated Current: **10A**
 Cables: **2x0.75mm²**

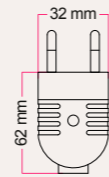

Finish	Code
--------	------

- White SPIT10A2PBI
- Black SPIT10A2PNE



Plug with ground

Material: **Thermoplastic**
 Voltage: **250 V**
 Rated Current: **10A**
 Cables: **2x0.75mm²/3x0,75mm²**

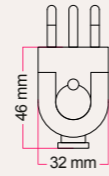

Finish	Code
--------	------

- White 82510-E
- Black 82511-E



Schuko comfort plug with ring

Material: **Thermoplastic**
 Voltage: **250 V**
 Rated Current: **16A**
 Cables: **2x0.75mm²/3x0,75mm²/3x1,5mm²**

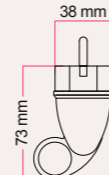

Finish	Code
--------	------

- White ST16A1BI
- Black ST16A1NE



Schuko Plug

Material: **Thermoplastic**
 Voltage: **250 V**
 Rated Current: **16A**
 Cables: **2x0.75mm²/3x0,75mm²/3x1,5mm²**

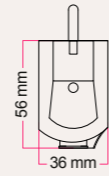

Finish	Code
--------	------

- White 80070-E
- Black 80071-E

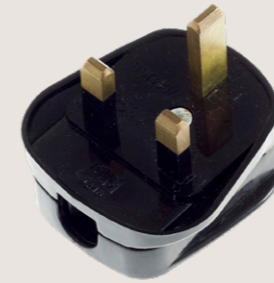

UK 3 poles Plug

Material: **Thermoplastic**
 Voltage: **250 V**
 Rated Current: **13A**
 Cables: **2x0.75mm²/3x0,75mm²**

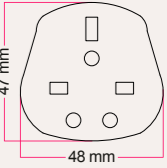

Finish	Code
--------	------

- White SPIN3PBI
- Black SPIN3PN



Two-Pole Socket

Material: **Thermoplastic**
 Voltage: **250 V**
 Rated Current: **10A**
 Cables: **2x0.75mm²**

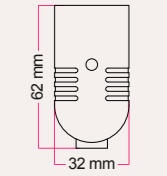

Finish	Code
--------	------

- White PRIT10A2PBI
- Black PRIT10A2PNE



Two-Pole EU Socket

Material: **Thermoplastic**
 Voltage: **250 V**
 Rated Current: **10A**
 Cables: **2x0.75mm²**

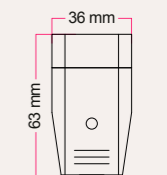

Finish	Code
--------	------

- White PRSEUB
- Black PRSEUN



Schuko comfort socket with ring

Material: **Thermoplastic**
 Voltage: **250 V**
 Rated Current: **16A**
 Cables: **2x0.75mm²/3x0,75mm²/3x1,5mm²**

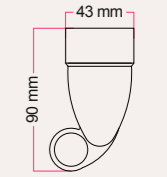

Finish	Code
--------	------

- White PVT16A1BI

ELECTRICAL ACCESSORIES

Splicing connectors are essential for completing your lighting installations. They are sold individually or in bulk boxes (10 or 100 pieces).



Universal Splicing Connectors

Material: **Thermoplastic** CE
UK
CB



Poles: **2**

Voltage/Amperage: **450V/24A**

Section: **2 x 0.2-2.5 mm²**

Finish **Code**

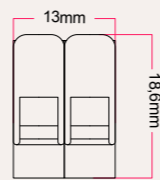
Transparent MOR412

Universal Splicing Connectors

Material: **Thermoplastic** CE
UK
CB



Poles: **3**

Voltage/Amperage: **450V/24A**

Section: **2 x 0.2-2.5 mm²**

Finish **Code**

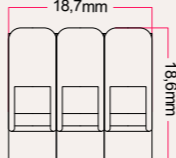
Transparent MOR413

Universal Splicing Connectors

Material: **Thermoplastic** CE
UK
CB

Poles: **5**

Voltage/Amperage: **450V/24A**

Section: **2 x 0.2-2.5 mm²**

Finish **Code**

Transparent MOR415

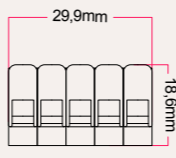

CONNECTION KIT FOR FLUSH-MOUNTED CEILING ROSES

The connection kit for suspension with flush-mounted ceiling rose enables fast and secure connections. The plastic box acts as insulation, it is equipped with two cable clamps, one on each side, which ensure the safety and solidity of the cables.



Connection kit

Material: **Thermoplastic** CE

Voltage/Amperage: **450V/24A**

Cable: **0.75 mm² to 2.5 mm²**

Number of inputs per side: **6**

Finish **Code**

Black MORINC

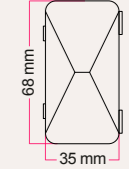

ADAPTORS FOR TRACKS

Thanks to this multiadaptor you can enrich your electrified track with some suspended lights made with our fabric cables, that can be placed and mounted where desired.



Eutrac white suspension

Material: **Polycarbonate** CE

Voltage: **250 V**

Maximum : **6A**

Clamp: **for maximum 3x0,75 cables**

Finish **Code**

White KTRACB

Black KTRACN

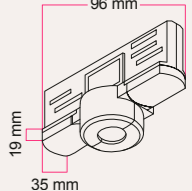



LIGHT BULBS

Illuminate your spaces with our versatile selection of bulbs. From warm ambience to bright productivity, discover the perfect lighting for any setting.

X00 - Y00
Shape Fitting

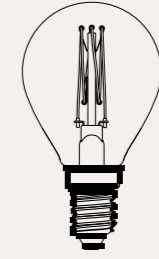

000000
Reference

W K Lm
Power Colour Light
 temperature emission

Height, Length

5V E27 LIGHTBULBS

Combining a vintage shell with a modern core, this 5 Volt light bulb collection is compatible exclusively with 5V-powered lamps. These light bulbs were designed to be both charming and versatile, as 5V lamps are typically powered by USB cords, batteries, or power banks.

E27



220V/240 E14 LIGHTBULBS

The E14 socket light bulbs, with their small base and compact dimensions, are perfect for table lamps, chandeliers, wall sconces, and other compact fixtures. They are commonly used in table lamps, chandeliers, wall sconces, and similar fixtures.

Candle

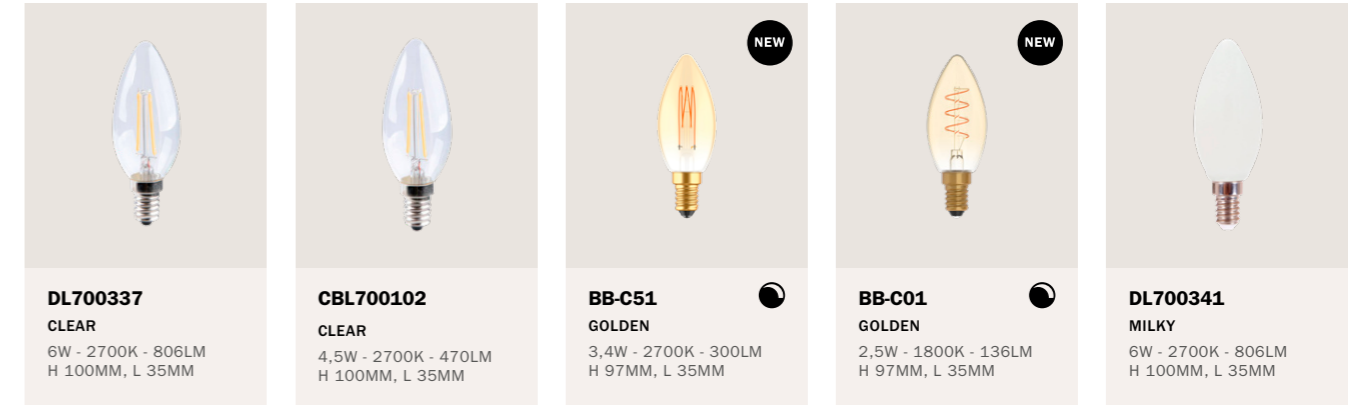

G45 - G50

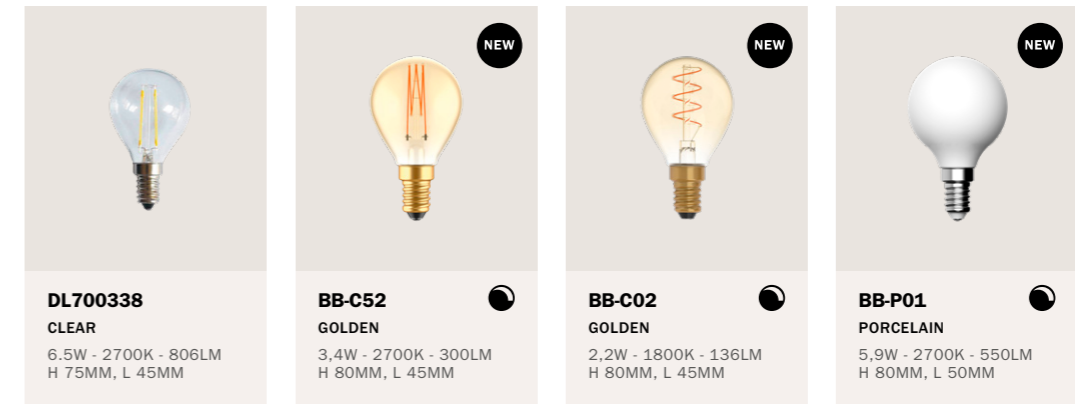

OTHER SHAPES



Compatible with
Cableless portable and
rechargeable lamps



220V/240 E27 LIGHTBULBS

The white porcelain diverter with knob is a vintage component used to control a single light from multiple locations. Made from high quality materials and perfected with an elegant finish, this diverter is ideal for those looking to achieve a vintage atmosphere in their home or office space.

G45

			
BB-E01 CLEAR 4W - 2700K - 470LM H 80MM, L 45MM	DL700675 CLEAR 2W - 2700K - 136LM H 78MM, L 45MM	BB-M01 MILKY 4W - 2700K - 470LM H 80MM, L 45MM	DL700674 MILKY 2.2W - 2700K - 136LM H 78MM, L 45MM

G80

BB-C05 GOLDEN 4W - 1800K - 250LM H 122MM, L 80MM

A60

				
BB-T01 CLEAR 7W - 2700K - 806LM H 108MM, L 60MM	BB-N01 CLEAR 7W - 3500K - 806LM H 108MM, L 60MM	BB-E02 CLEAR 4W - 2700K - 470LM H 108MM, L 60MM	BB-C53 GOLDEN 7W - 2700K - 640LM H 108MM, L 60MM	BB-C03 GOLDEN 4W - 1800K - 250LM H 108MM, L 60MM
				
DL700182 HALF CUP COPPER 7W - 2700K - 806LM H 106MM, L 60MM	DL700289 HALF CUP GOLD 7W - 2700K - 660LM H 106MM, L 60MM	BB-M02 MILKY 4W - 2700K - 470LM H 108MM, L 60MM	BB-P06 PORCELAIN 7W - 2700K - 640LM H 108MM, L 60MM	

ST64

				
BB-T02 CLEAR 7W - 2700K - 806LM H 149MM, L 64MM	BB-N02 CLEAR 7W - 3500K - 806LM H 149MM, L 64MM	BB-E03 CLEAR 4W - 2700K - 470LM H 149MM, L 64MM	BB-C54 GOLDEN 7W - 2700K - 640LM H 149MM, L 64MM	BB-C04 GOLDEN 4W - 1800K - 250LM H 149MM, L 64MM
				
DL700181 SMOKY 5W - 2000K - 150LM H 145MM, L 64MM	BB-F03 SMOKY 2.2W - 1800K - 60LM H 149MM, L 64MM	BB-M03 MILKY 4W - 2700K - 470LM H 149MM, L 64MM	BB-P02 PORCELAIN 7W - 2700K - 640LM H 149MM, L 64MM	

G95

 BB-T03 CLEAR 7W - 2700K - 806LM H 140MM, L 95MM	 BB-N03 CLEAR 7W - 3500K - 806LM H 140MM, L 95MM	 BB-E04 CLEAR 4W - 2700K - 470LM H 140MM, L 95MM	 BB-C55 GOLDEN 7W - 2700K - 640LM H 140MM, L 95MM	 BB-C06 GOLDEN 4W - 1800K - 250LM H 140MM, L 95MM
 DL700180 SMOKY 5W - 2000K - 150LM H 135MM, L 95MM	 DL700176 HALF CUP SILVER 7W - 2700K - 806LM H 140MM, L 95MM	 DL700177 HALF CUP COPPER 7W - 2700K - 806LM H 140MM, L 95MM	 BB-C06 GOLDEN 4W - 1800K - 250LM H 140MM, L 95MM	 BB-M04 MILKY 4W - 2700K - 470LM H 140MM, L 95MM
 BB-P03 PORCELAIN 7W - 2700K - 640LM H 140MM, L 95MM	 DL700682 GOLDEN 2W - 2000K - 40LM H 135MM, L 95MM	 BB-F04 SMOKY 2,2W - 1800K - 60LM H 140MM, L 95MM		

G125

 BB-T04 CLEAR 7W - 2700K - 806LM H 178MM, L 125MM	 BB-N04 CLEAR 7W - 3500K - 806LM H 178MM, L 125MM	 BB-E05 CLEAR 4W - 2700K - 470LM H 178MM, L 125MM	 BB-C56 GOLDEN 7W - 2700K - 640LM H 178MM, L 125MM	 BB-C07 GOLDEN 4W - 1800K - 250LM H 178MM, L 125MM
 DL700179 SMOKY 5W - 1800K - 150LM H 125MM, L 175MM	 BB-F05 SMOKY 2,8W - 1800K - 90LM H 178MM, L 125MM	 DL700174 HALF CUP SILVER 7W - 2700K - 806LM H 175MM, L 125MM	 DL700175 HALF CUP COPPER 7W - 2700K - 806LM H 175MM, L 125MM	 BB-M05 MILKY 4W - 2700K - 470LM H 178MM, L 125MM
 BB-P04 PORCELAIN 7W - 2700K - 640LM H 178MM, L 125MM	 DL700267 CLEAR 4,5W - 1800K - 105LM H 172MM, L 125MM	 DL700683 GOLDEN 2W - 2000K - 40LM H 175MM, L 125MM	 CBL700232 GOLDEN 5W - 2000K - 250LM H 175MM, L 125MM	 CBL700216 GOLDEN 5W - 2000K - 250LM H 175MM, L 125MM

G150

 BB-P05 PORCELAIN 7W - 2700K - 640LM H 192MM, L 150MM

Other Shapes

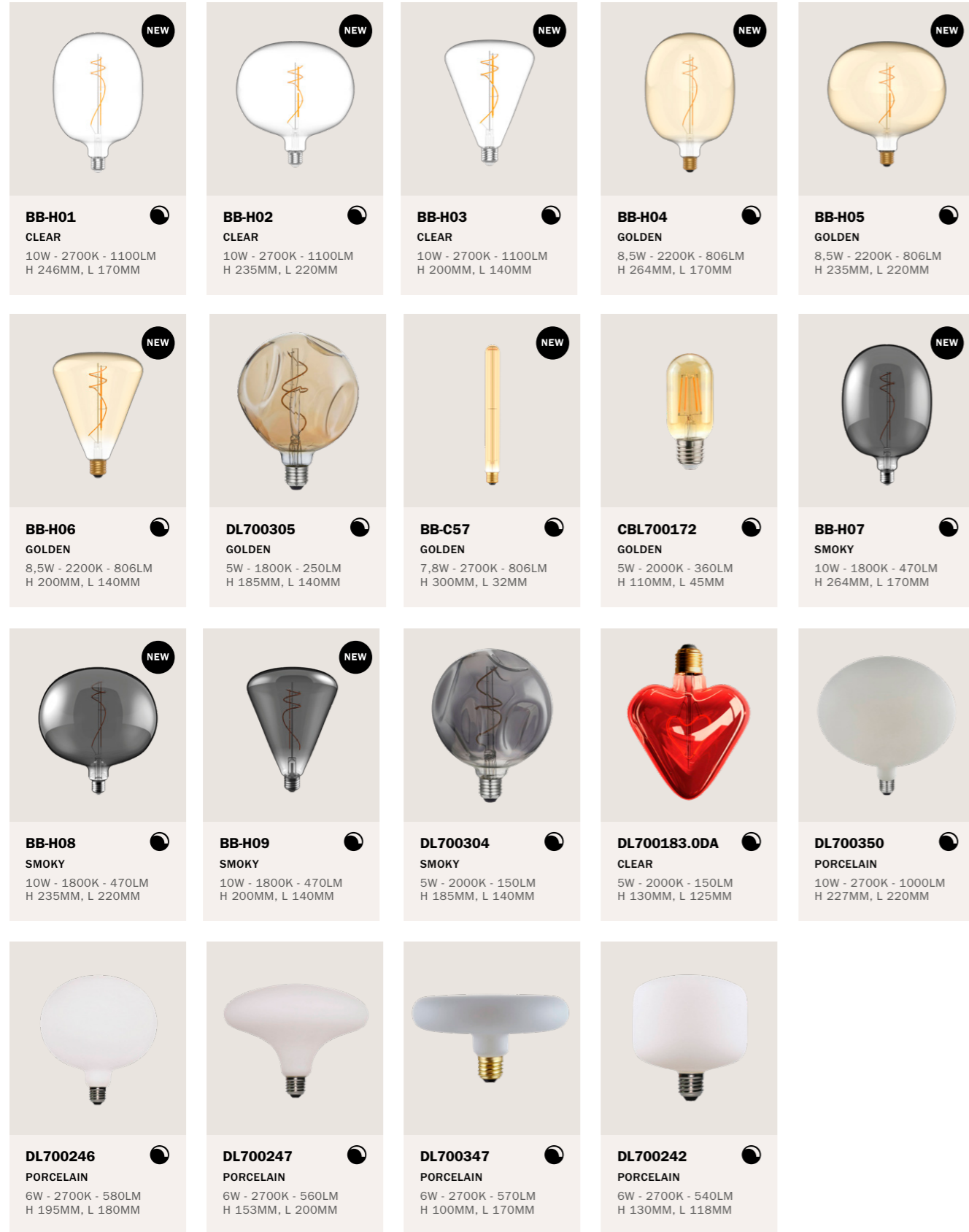

NEW

PLUMEN-001
PORCELAIN EFFECT
 6,5W - 3500K - 500LM
 H 160MM, L 101MM

UL listed E26 fitting is also available

Revolutionary, iconic, unique. This light bulb is the first energy-saving designer light bulb in the world. It has received several prestigious awards and has been featured in prominent international magazines.

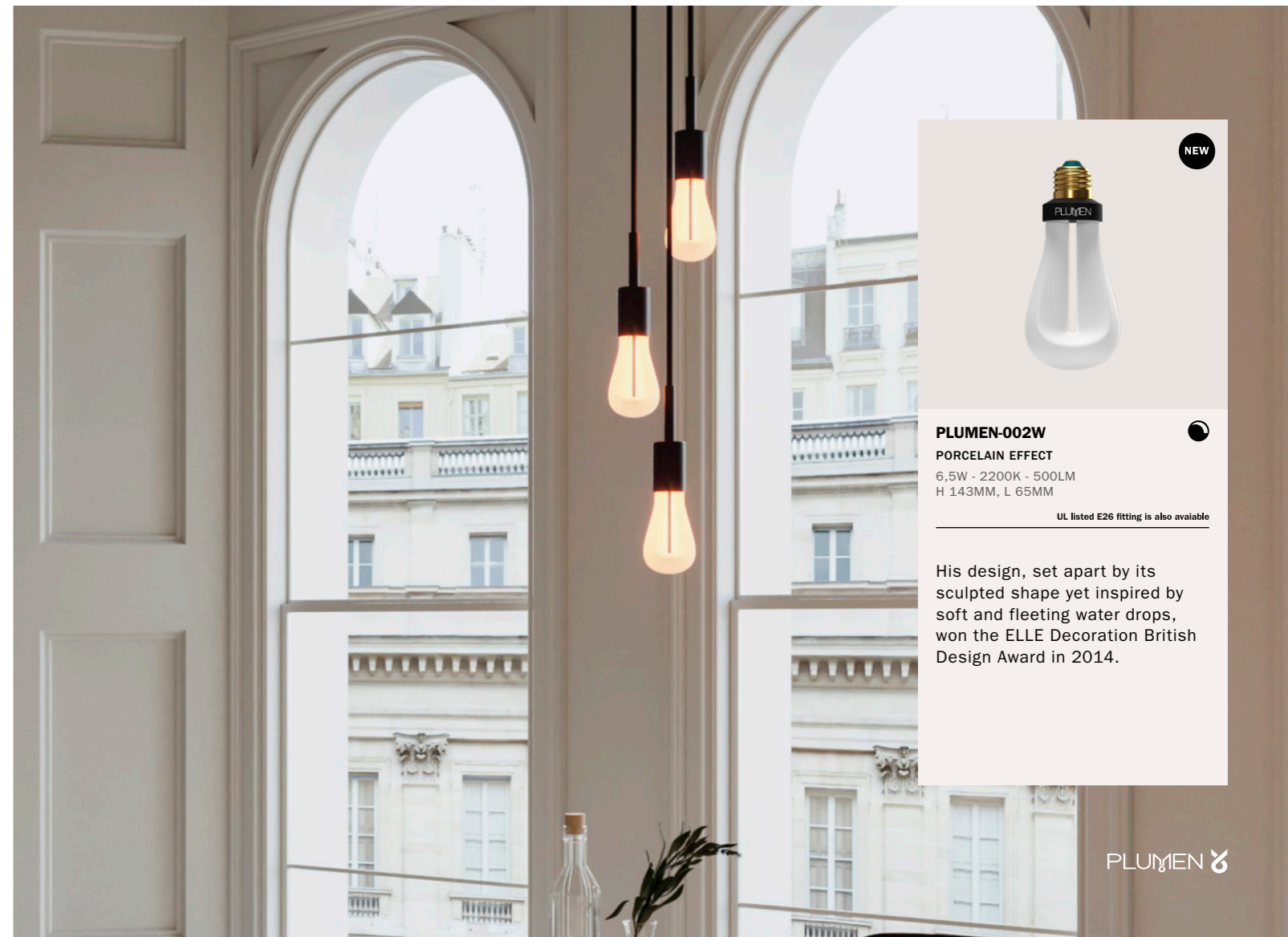

NEW

PLUMEN-002W
PORCELAIN EFFECT
 6,5W - 2200K - 500LM
 H 143MM, L 65MM

UL listed E26 fitting is also available

His design, set apart by its sculpted shape yet inspired by soft and fleeting water drops, won the ELLE Decoration British Design Award in 2014.

Floating



SEG55056
SMOKY
6W - 1900K - 220LM
H 165MM, L 125MM

SEG55057
SMOKY
6W - 1900K - 260LM
H 185MM, L 150MM

SEG55058
SMOKY
6W - 1900K - 240LM
H 230MM, L 200MM

SEG55060
SMOKY
8W - 1900K - 350LM
H 320MM, L 300MM

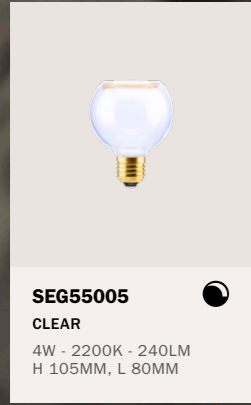

SEG55005
CLEAR
4W - 2200K - 240LM
H 105MM, L 80MM

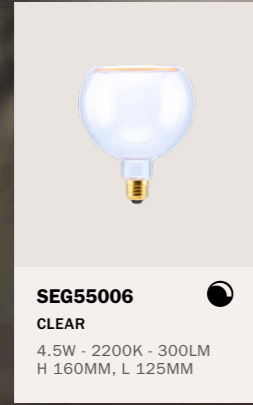

SEG55006
CLEAR
4.5W - 2200K - 300LM
H 160MM, L 125MM



SEG55007
CLEAR
4.5W - 2200K - 300LM
H 185MM, L 150MM



SEG55008
CLEAR
5W - 2200K - 350LM
H 230MM, L 200MM



SEG55001
CLEAR
4.5W - 2200K - 300LM
H 90MM, L 90MM



Ghost



BB-G01
CLEAR
6W - 2200K - 500LM
H 157MM, L 195MM

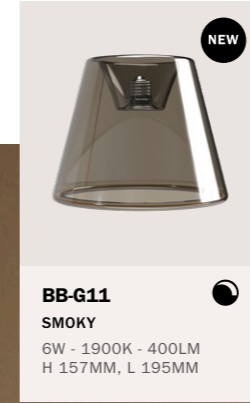

BB-G11
SMOKY
6W - 1900K - 400LM
H 157MM, L 195MM

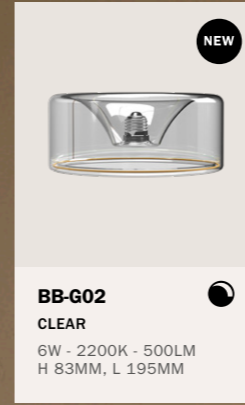

BB-G02
CLEAR
6W - 2200K - 500LM
H 83MM, L 195MM

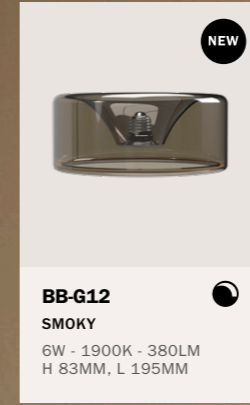

BB-G12
SMOKY
6W - 1900K - 380LM
H 83MM, L 195MM

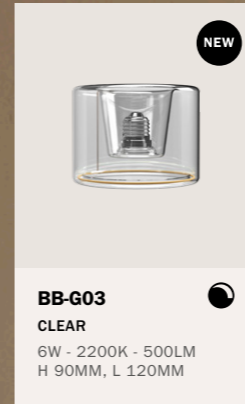

BB-G03
CLEAR
6W - 2200K - 500LM
H 90MM, L 120MM

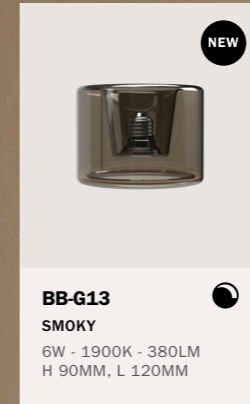

BB-G13
SMOKY
6W - 1900K - 380LM
H 90MM, L 120MM

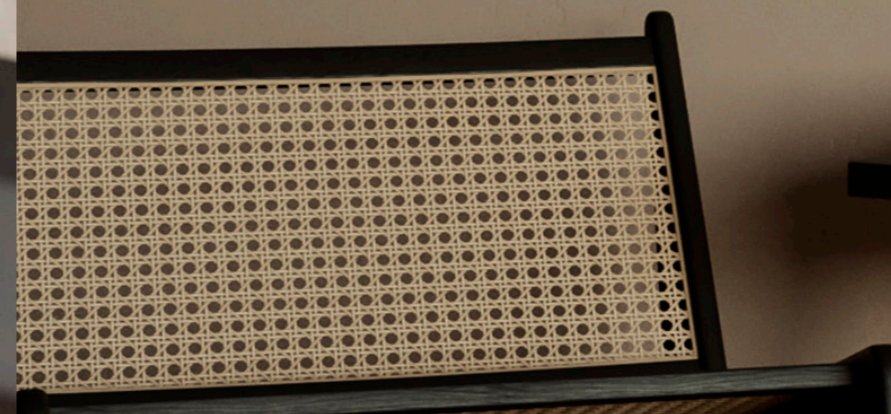

220V S14D

Simplicity and elegance define these linear light bulbs, emitting a calming, uniform glow. Available in various sizes, ranging from 30 cm to 100 cm, and a range of finishes, they seamlessly blend with any decor and personal style. They are equally striking on their own or as part of creative compositions.

Clear

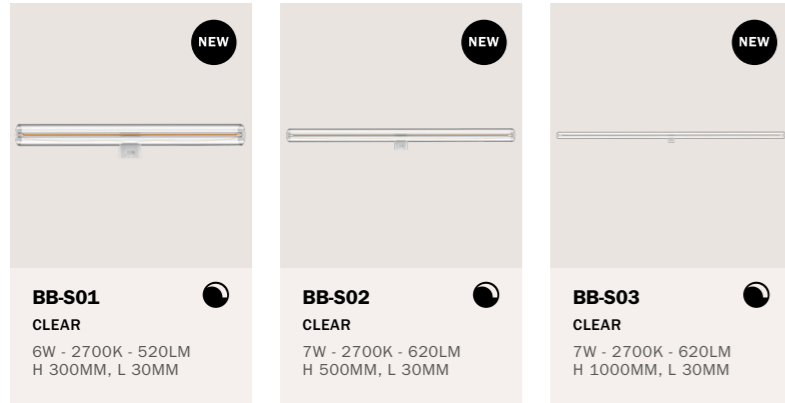

Porcelain effect

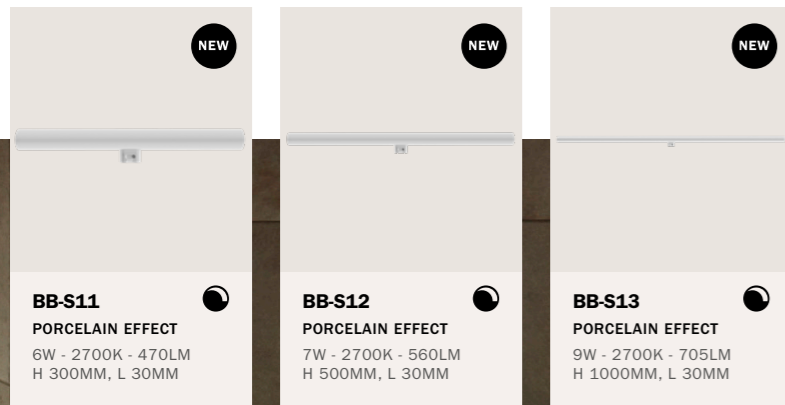



B2B SERVICES

Choice

We offer hundreds of IMQ-HAR or UL certified cables made in Italy, complemented by a variety of lighting accessories and high-quality light bulbs that can generate thousands of combinations. Our assortment is regularly reviewed to set or match current lighting trends.

Assembly

We can assemble and certify almost any of our products together to create your desired ready-to-use lamps that only need to be positioned and switched on. Simply nominate the components you need and contact us to receive the best quotes available complete with volume breaks for larger quantities. The more you buy, the more you save.

Customization

Anything can be possible at Creative Cables. We like to explore your ideas and encourage your creativity: if what you want is feasible, we can make it happen. We are the producer, so ask us if we can create what you need.

We are available to provide you with cables in different colors than those offered, to cover special cables, or to send you pre-processed cables (cut, stripped, etc.). We can also customize lamp bases and lampshades for you using processes like engraving or laser etching, with a minimum order requirement. If you have special requests, just ask us, and we'll see how we can assist you.

Service

Our B2B website is active 24/7: In addition, each B2B customer receives dedicated support from a qualified account manager who can assist you throughout the process before, during and after the sale.

Logistics

B2B orders of any size can be prepared within 5 working days, 80% of our orders are dispatched within 48 hours. We have mastered our efficiency to allow you to receive what you need when you need it. For special customized products or assemblies, we can advise approximate lead times to ensure you have all the information you need to plan accordingly.

Point of sale materials

We have boxed products and sample displays cases. Corners Display Panels are the solution to display a wide selection of products in your store or showroom to maximize sales by properly expressing the idea of possibilities of light installations that can be obtained with Creative Cables components.

CONFIGURATOR CORNER

The inspiration

Our architects will design an installation in your shop, with a few selected products to intrigue, help and inspire your customers.

Play

A dedicated version of the Creative Cables Configurator for customers to use on wall-mounted touch screens, computers, tablets or smartphones, accompanied by a salesperson or on their own. Customers create their custom-made lamp, while playing.

Touch

A material library (optional) organised in drawers for people to touch, check colour combinations and confirm choices.

The Configurator Corner makes selling custom products a simple and automated process: no IT integration, no catalogues to learn or consult, no codes and prices to remember. Hundreds of thousands of possible configurations with no need to stock the product. The selection of configurable models can be customised to match the offer of the point of sale and the customer retail price level is also fully configurable.

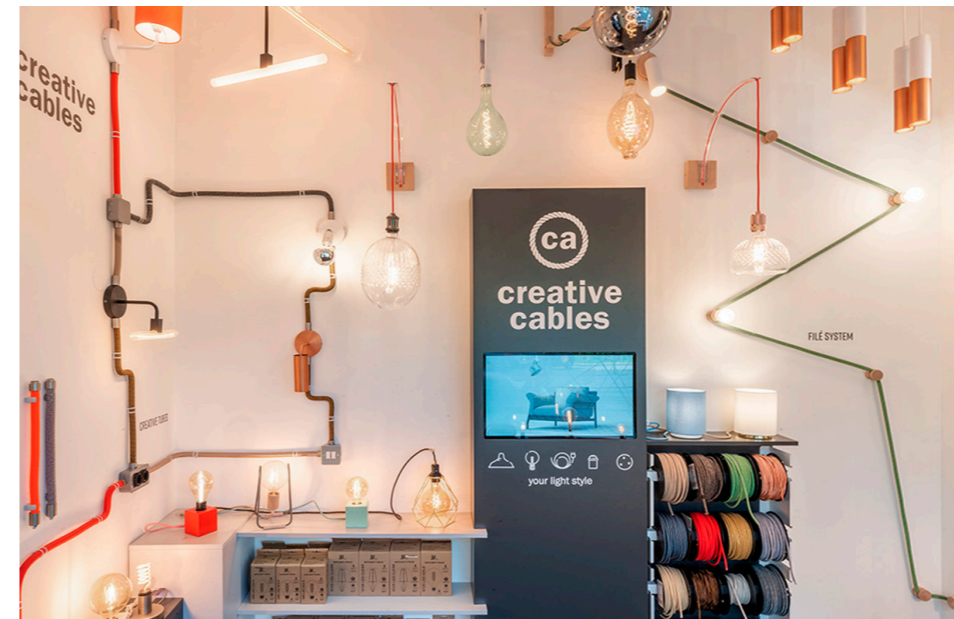

WHO IS IT DEDICATED TO?

Configurator Corner has been thought for a selected number of Point of sale.

- Lighting shops
- Furniture shops
- Concept Stores
- Home accessory shops
- Garden centres and outdoor furniture

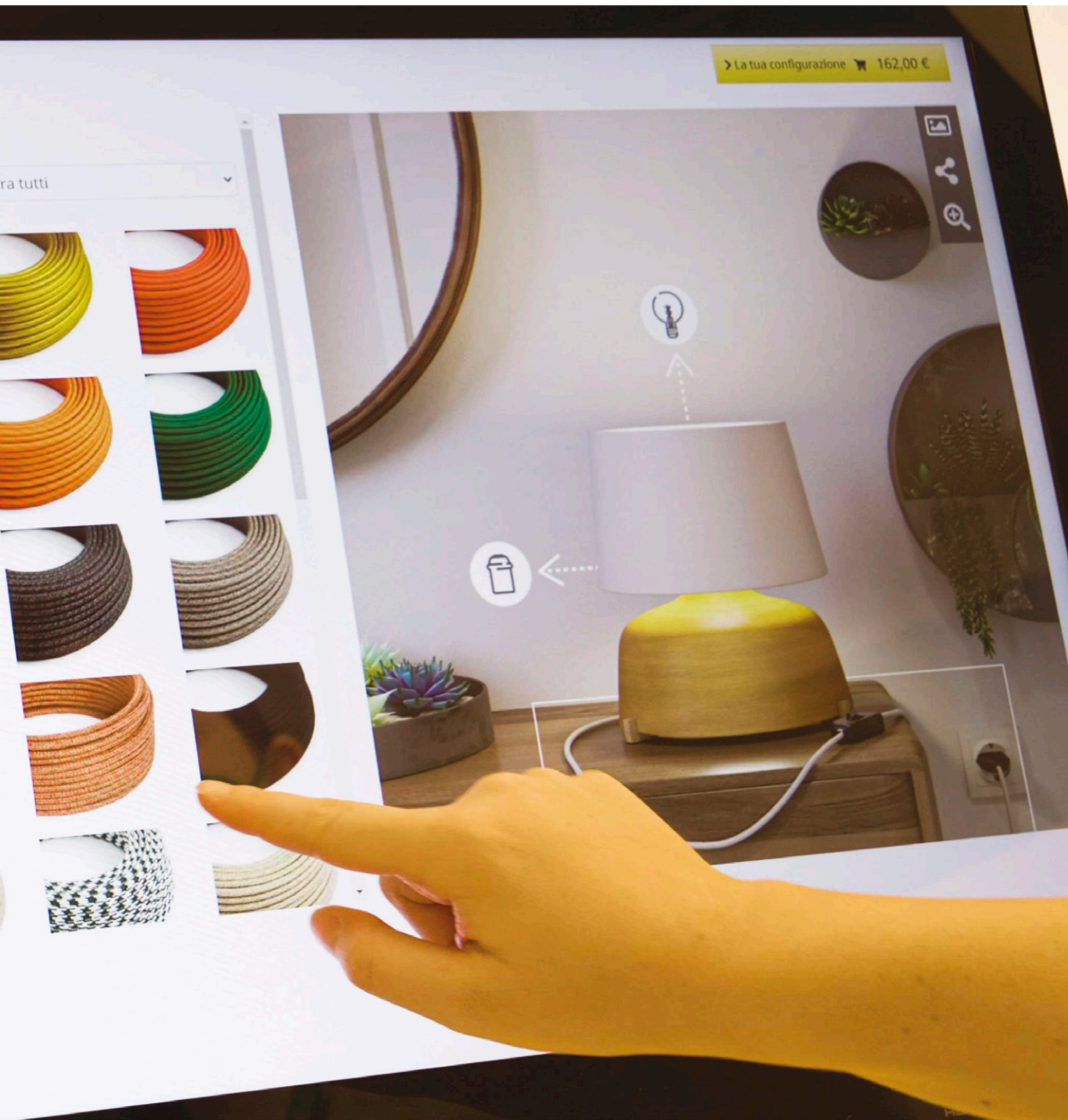

HOW MUCH SPACE IS REQUIRED?

- From 0,5 to 10 square metres
- At least one free wall

HOW MUCH SPACE IS REQUIRED?

Little, very little and in any case, it varies according to the individual project depending on the amount of material to be displayed, which device will be used for the configurator and the use of the material library.

- The installation and use of the configurator is completely free of charge.
- The design of the space is handled by Creative Cables.

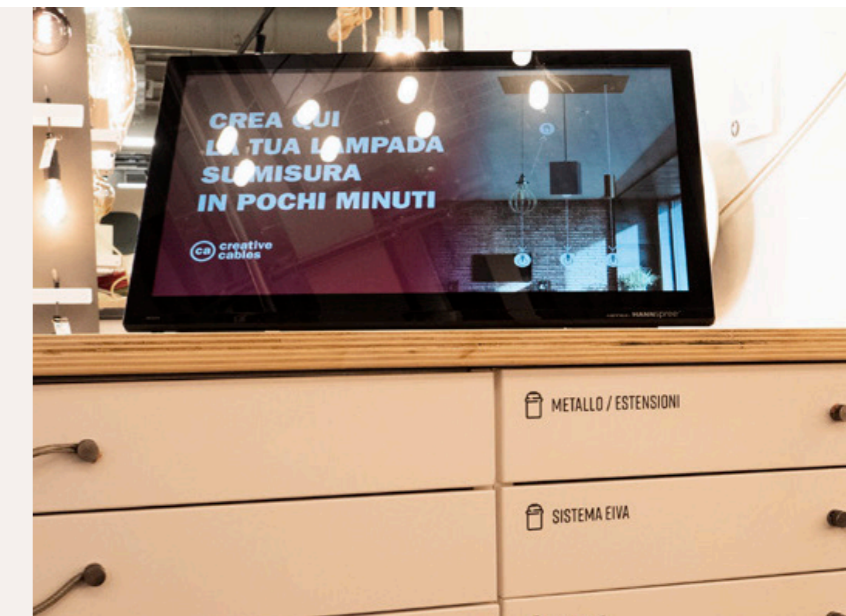

WHAT DO WE OFFER?

- Free of charge and customised design of the display according to the needs and type of space.
- Touch screen configurator: the customer composes the lamp of their desire and receive it in the shop, with no stock commitment for the point of sale.
- Material library: a set of customised drawer units (optional) for the customer to "touch" the materials used in the configurator.
- An automatic order system to make the procurement process quick and easy.
- Extra discounts on the displayed products.
- Location on www.CreativeCables.com as an official Corner where you can find Creative Cables products.



DISPLAY CASES

The white porcelain diverter with knob is a vintage component used to control a single light from multiple locations. Made from high quality materials and perfected with an elegant finish, this diverter is ideal for those looking to achieve a vintage atmosphere in their home or office space.



EIVA Mini Creative Box - Counter display unit

Code: **MCB-EIVA2**

Dimensions: **l 410mm, h 505mm, w 305mm**

A tool that will make it easier for the customer to choose and for the retailer to sell. Despite its small size, the display unit contains all the components of EIVA outdoor lighting system: the two Pastel or Elegant lines, the 8 silicone finishes available, the selection of Creative Cables cables for outdoor use and the innovative and patented lamp holder. The display unit is shipped pre-assembled, thereby avoiding the hassle of having to follow any assembly instructions. Just open the box to display it and start selling! Contact your local B2B sales team to find out how to get an EIVA Mini Creative Box with your next order.



Reel Display Kit

Code: **ESP8REEL**

Dimensions: **l 62cm, h 23cm, w 11cm**

The Reel Display Kit is a simple and elegant solution for displaying Creative Cables cables on a wall. Each kit consists of 2 lateral leg loops with logo and 2 bars, to easily exhibit up to 8 reels of cable. The cable reels are not included, but are supplied by default with the purchase of 50 meters of lighting cable and 25 meters of cable for string lighting cables (or relative multiples).

Contact Informations

Local contacts for B2C market

Creative Cables Australia

info.au@creative-cables.com
+61 (0) 733 67 26 64
www.creative-cables.com.au

Creative Cables Austria

info.de@creative-cables.com
+49 681 95 26 40 34
www.creative-cables.at

Creative Cables Belgium

info.be@creative-cables.com
+32 02 732 82 32
www.creative-cables.be

Creative Cables Colombia

info.co@creative-cables.com
+57 4/322 47 66
www.creative-cables.co

Creative Cables Croatia

info.hr@creative-cables.com
+385 95 396 8385
www.creative-cables.hr

Creative Cables Czech Republic

info.cz@creative-cables.com
+420 228 884 494
www.creative-cables.cz

Creative Cables Denmark

info.dk@creative-cables.com
+46 8 44688492
www.creative-cables.dk

Creative Cables France

info.fr@creative-cables.com
+33 372 64 00 41
www.creative-cables.fr

Creative Cables Germany

info.de@creative-cables.com
+49 681 95 26 40 34
www.creative-cables.de

Creative Cables Greece

info.gr@creative-cables.com
+30 231 05 31 938
www.creative-cables.gr

Creative Cables Hungary

info.hu@creative-cables.com
+36704296100
www.creative-cables.hu

Creative Cables Italy

info.it@creative-cables.com
+39 800 03 41 80
www.creative-cables.it

Creative Cables Netherlands

info.nl@creative-cables.com
+32 2 73 28 232
www.creative-cables.nl

Creative Cables Portugal

info.pt@creative-cables.com
+351 282 41 28 54
www.creative-cables.pt

Creative Cables Slovakia

info.sk@creative-cables.com
+420 228 884 494
www.creative-cables.sk

Creative Cables Slovenia

info.si@creative-cables.com
+386 (0) 516 06 252
www.creative-cables.si

Creative Cables South Africa

info.za@creative-cables.com
+24 064 54 76 054
www.creative-cables.co.za

Creative Cables Spain

info.es@creative-cables.com
+34 960 62 77 49
www.creative-cables.es

Creative Cables Sweden

info.se@creative-cables.com
+46 8 44688492
www.creative-cables.se

Creative Cables Switzerland

info.ch@creative-cables.com
+41 793 57 43 56
www.creative-cables.ch

Creative Cables UK

info.uk@creative-cables.com
+44 (0) 203 94 07 550
www.creative-cables.co.uk

Creative Cables USA

info.us@creative-cables.com
+1 901 35 95 128
www.creative-cables.us

International Contact B2B Creative Cables

Headquarter

website: b2b.creative-cables.com
warehouse location: Lungo Dora P. Colletta n.113/9
10153, Torino (TO) - Italia
email: info.b2b@creative-cables.com
phone: +39 011 24 78 463

Local Contacts B2B

Benelux

website: b2b-benelux.creative-cables.com
email: b2b.benelux@creative-cables.com
phone: +32 (0) 349 24 40

France

website: b2b.creative-cables.fr
email: b2b.fr@creative-cables.com
tel: +33 372 64 00 38

Germany

website: b2b.creative-cables.de
email: b2b.de@creative-cables.com
tel: +49 681 95 26 40 33

Hungary

website: b2b.creative-cables.hu
email: b2b.hu@creative-cables.com
tel: +36704296100

Italy

website: b2b.creative-cables.it
email: b2b.it@creative-cables.com
tel: +39 011 2478463

Nordic - Sweeden & Denmark

website: b2bnordic.creative-cables.com
email: b2bnordic@creative-cables.com
tel: +44 (0) 2039401748

Spain

website: b2b.creative-cables.es
email: b2b.es@creative-cables.com
tel: +34 960 62 77 69

United Kingdom

website: b2b.creative-cables.co.uk
email: b2b.uk@creative-cables.com
tel: +44 (0) 203 94 01 748

USA

website: www.creative-cables.us
email: info.us@creative-cables.com
tel: +1 901 35 95 128

Stores

Creative Cables Store Turin

Via Giuseppe Mazzini 24D,
Torino
+39 011-8397816
negoziotorino@creative-cables.com

Creative Cables Store Parma

Borgo Gian Domenico Romagnosi 8,
Parma
+39 05-211680531
storeparma@creative-cables.com

Creative Cables Store Milan

Via Edmondo De Amicis 50,
Milano
+39 02-38317349
storemilano@creative-cables.com

Creative Cables Store Treviso

Viale Montegrappa 58,
Treviso
+39 3996149462
storetreviso@creative-cables.com

Creative Cables Store Rome

Via Alessandria 100,
Roma
+39 06-92594377
storeroma@creative-cables.com

Creative Cables Store Paris

Rue du Bac 19,
7^e arrondissement, Paris
+33 (0) 1 40261873
storeparis@creative-cables.com

Creative Cables Store Budapest

József krt. 44,
1085, Budapest
+36 70 429 6100
info.hu@creative-cables.com

Creative Cables Store Tenerife

Calle San Clemente, 21
38003, Santa Cruz de Tenerife
+34 922415876
storetenerife@creative-cables.com

Creative Cables Store Marsiglia

51 Rue de la République
13002, Marseille
storemarseille@creative-cables.com

Creative Cables Store Zagreb

Nova Cesta, 109
10000, Zagabria
+385 95 396 8385
storezagreb@creative-cables.com

Creative Cables Store Bruxelles

Rue de Stalle, 288 A
1180, Uccle
+32 27328232
storebruxelles@creative-cables.com

Creative Cables Store Ljubljana

Poljanska Cesta, 13
1000, Ljubljana
+386 051 606 252
storeljubljana@creative-cables.com

Creative Cables is a brand of the Mosaic S.p.A. group,
which also includes Bebulbs and Plumen.

MOSAIC

COPYRIGHT BY MOSAIC S.P.A.
IT IS FORBIDDEN TO COPY THE CATALOGUE, EVEN PARTIALLY.

In the ongoing search for technical and functional improvements, Mosaic reserves the right to make changes, substantial or not, to its products, which may be put into effect without prior notice.
The images and the colours are provided for general information purposes only and are not binding for Mosaic.

